

**PLEASE CHECK WWW.MOLEX.COM FOR LATEST PART INFORMATION**

**Part Number:** [0436500510](#)  
**Status:** **Active**  
**Overview:** [microfit\\_30](#)  
**Description:** 3.00mm (.118") Pitch Micro-Fit 3.0™ Header, Surface Mount Compatible, Single Row, Right Angle, with PCB Press-fit Metal Retention Clip, 5 Circuits, 0.38µm (15µ") Gold (Au) Selective Plating, Glow Wire Compatible

**Documents:**

[3D Model](#) [Product Specification PS-43650 \(PDF\)](#)  
[Drawing \(PDF\)](#) [RoHS Certificate of Compliance \(PDF\)](#)

**Agency Certification**

|     |           |
|-----|-----------|
| CSA | LR19980   |
| TUV | R72081037 |
| UL  | E29179    |

**General**

|                             |   |
|-----------------------------|---|
| Product Family              | PCB Headers                             |
| Series                      | <a href="#">43650</a>                   |
| Application                 | Wire-to-Board                           |
| Comments                    | High Temperature Square Pin Solder Type |
| Overview                    | <a href="#">microfit_30</a>             |
| Product Literature Order No | USA-106                                 |
| Product Name                | Micro-Fit 3.0™                          |

**Physical**

|                                |                                |
|--------------------------------|--------------------------------|
| Breakaway                      | No                             |
| Circuits (Loaded)              | 5                              |
| Circuits (maximum)             | 5                              |
| Color - Resin                  | Black                          |
| Durability (mating cycles max) | 30                             |
| Flammability                   | 94V-0                          |
| Glow-Wire Compliant            | Yes                            |
| Mated Height (in)              | 0.275 In                       |
| Mated Height (mm)              | 6.98 mm                        |
| Material - Metal               | Brass                          |
| Material - Plating Mating      | Gold                           |
| Material - Plating Termination | Tin                            |
| Material - Resin               | High Temperature Thermoplastic |
| Number of Rows                 | 1                              |
| Orientation                    | Right Angle                    |
| PCB Locator                    | Yes                            |
| PCB Retention                  | Yes                            |
| PCB Thickness Recommended (in) | 0.062 In                       |
| PCB Thickness Recommended (mm) | 1.60 mm                        |
| Packaging Type                 | Embossed Tape on Reel          |
| Pitch - Mating Interface (in)  | 0.118 In                       |
| Pitch - Mating Interface (mm)  | 3.00 mm                        |
| Plating min: Mating (µin)      | 15                             |
| Plating min: Mating (µm)       | 0.38                           |
| Plating min: Termination (µin) | 100                            |
| Plating min: Termination (µm)  | 2.50                           |
| Polarized to PCB               | Yes                            |
| Shrouded                       | Fully                          |
| Stackable                      | No                             |
| Temperature Range - Operating  | -40°C to +105°C                |

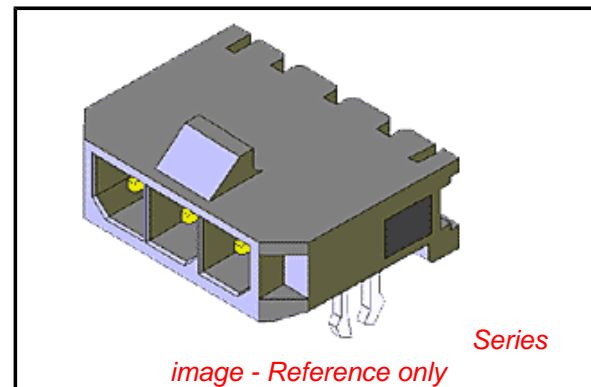

**EU RoHS**

**ELV and RoHS Compliant**  
**REACH SVHC Contains SVHC: No**  
**Halogen-Free Status**  
**Not Reviewed**

**China RoHS**



**Need more information on product environmental compliance?**

Email [productcompliance@molex.com](mailto:productcompliance@molex.com)  
 For a multiple part number RoHS Certificate of Compliance, [click here](#)

Please visit the [Contact Us](#) section for any non-product compliance questions.

**Search Parts in this Series**

[43650Series](#)

**Mates With**

[43645 Micro-Fit 3.0™ Receptacle Housing](#)

Termination Interface: Style Surface Mount

### **Electrical**

Current - Maximum per Contact 5A  
Voltage - Maximum 250V

### **Solder Process Data**

Duration at Max. Process Temperature (seconds) 30  
Lead-free Process Capability Reflow Capable (SMT only)  
Max. Cycles at Max. Process Temperature 3  
Process Temperature max. C 260

### **Material Info**

#### **Reference - Drawing Numbers**

Packaging Specification PK-70873-07\*\*  
Product Specification PS-43650  
Sales Drawing SD-43650-004  
Test Summary TS-43045-002

This document was generated on 05/24/2010

**PLEASE CHECK [WWW.MOLEX.COM](http://WWW.MOLEX.COM) FOR LATEST PART INFORMATION**

13 12 11 10 9 8 7 6 5 4 3 2 1

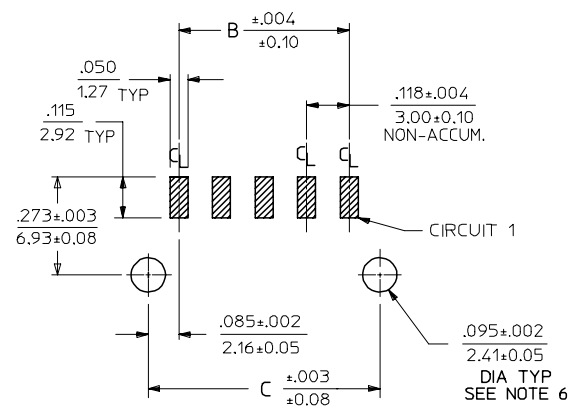
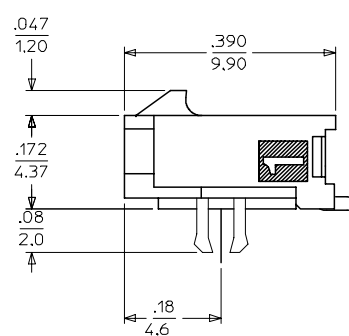
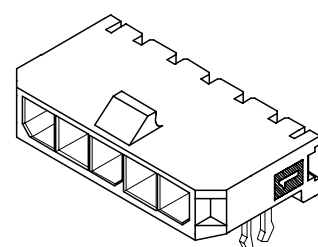
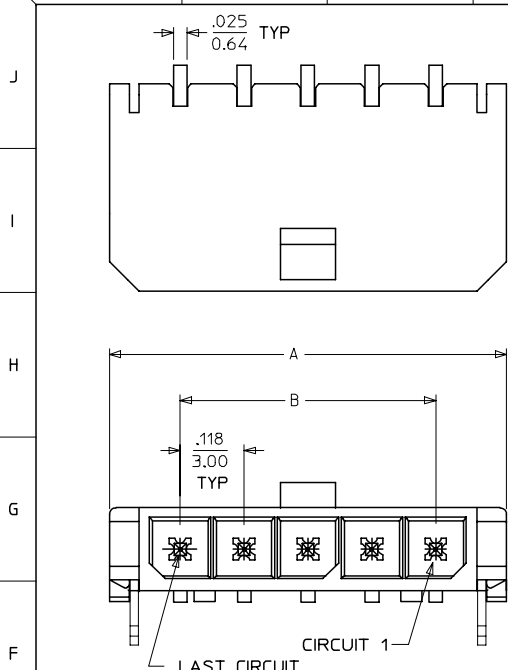

PCB LAYOUT: COMPONENT SIDE  
RECOMMENDED PCB THICKNESS: .062/157

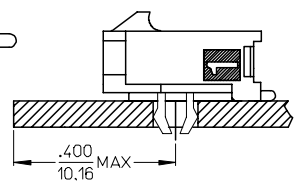

LOCATION DETAIL  
SEE NOTE #8

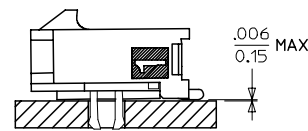

COPLANARITY DETAIL  
SEE NOTE #7

| CKTS | DIM A          | DIM B          | DIM C          |
|------|----------------|----------------|----------------|
| 2    | .380<br>9.65   | .118<br>3.00   | .287<br>7.30   |
| 3    | .498<br>12.65  | .236<br>6.00   | .405<br>10.30  |
| 4    | .616<br>15.65  | .354<br>9.00   | .524<br>13.30  |
| 5    | .734<br>18.64  | .472<br>12.00  | .642<br>16.30  |
| 6    | .852<br>21.64  | .591<br>15.00  | .760<br>19.30  |
| 7    | .970<br>24.64  | .709<br>18.00  | .878<br>22.30  |
| 8    | 1.088<br>27.64 | .827<br>21.00  | .996<br>25.30  |
| 9    | 1.206<br>30.63 | .945<br>24.00  | 1.114<br>28.30 |
| 10   | 1.325<br>33.66 | 1.063<br>27.00 | 1.232<br>31.30 |
| 11   | 1.443<br>36.65 | 1.181<br>30.00 | 1.350<br>34.30 |
| 12   | 1.561<br>39.65 | 1.299<br>33.00 | 1.469<br>37.30 |

NOTES:

- HOUSING MATERIAL: LIQUID CRYSTAL POLYMER, GLASS FILLED, UL94V-0, COLOR: BLACK  
TERMINAL MATERIAL: BRASS ALLOY
- FINISH:  
A = .000100/(0.00254) MIN. BRIGHT TIN OVER  
.000050/(0.00127) MIN. NICKEL  
B = .000015/(0.00038) MIN. SELECT GOLD IN CONTACT AREA  
.000100/(0.00254) MIN. SELECT MATTE TIN ON SOLDER TAILS  
BOTH OVER .000050/(0.00127) NICKEL OVERALL  
C = .000030/(0.00076) MIN. SELECT GOLD IN CONTACT AREA  
.000100/(0.00254) MIN. SELECT MATTE TIN ON SOLDER TAILS  
BOTH OVER .000050/(0.00127) NICKEL OVERALL  
\* THE PRIMARY SHIPPING CARTON WILL BE LABELED "COMPLIANT TO RoHS DIRECTIVE 2002/95/EC AND ELV ANNEX II OF DIRECTIVE 2000/53/EC." CARTONS WITHOUT THIS LABEL MAY CONTAIN PRODUCT WITH TIN/LEAD IN THE PC TAIL AREA.
- PRODUCT SPECIFICATION: PS-43650
- TAPE AND REEL PACKAGED : SEE MOLEX DRAWING PK-70873-07\*\*
- MATES WITH: RECEPTACLE NUMBER 43645
- TO MINIMIZE INSERTION FORCE ON MOUNTING CLIPS DURING ROBOTIC PLACEMENT, HOLE DIAMETER SPECIFICATIONS MUST BE INCREASED MAKING THEM MORE COMPATIBLE WITH PICK AND PLACE EQUIPMENT. HOLE DIAMETERS SHOULD BE INCREASED TO APPROXIMATELY .100±.002/(2.54±0.05) AND EVALUATED PER PLACEMENT EQUIPMENT.
- THE COPLANARITY DIMENSION IS ESTABLISHED BY PLACING THE ASSEMBLY ON A FLAT SURFACE. THE DISTANCE FROM THAT SURFACE TO THE BOTTOM OF ANY ANY TERMINAL MUST NOT EXCEED .006/0.15
- TO AVOID INTERFERENCE BETWEEN RECEPTACLE AND PCB, HEADER MUST BE PLACED WITHIN .400/(10.16) MAX. FROM EDGE OF PCB, AS SHOWN IN LOCATION DETAIL.
- A HIGHER TEMPERATURE GRADE MATERIAL (260C MAX. REFLOW TEMPERATURE) IS BEING PHASED-IN BEGINNING AUGUST 2007. PARTS WILL BE TEMPORARILY IDENTIFIED WITH A BLUE DOT ON THE PRIMARY SHIPPING CARTON LABEL UNTIL ALL CIRCUIT SIZES ARE CONVERTED, AT WHICH TIME A FULL-CONVERSION DATE WILL BE IDENTIFIED IN PS-43650.

| CKTS | FINISH A     | FINISH B     | FINISH C     |
|------|--------------|--------------|--------------|
|      | MATERIAL NO: | MATERIAL NO: | MATERIAL NO: |
| 02   | 43650-0209   | 43650-0210   | 43650-0211   |
| 03   | 43650-0309   | 43650-0310   | 43650-0311   |
| 04   | 43650-0409   | 43650-0410   | 43650-0411   |
| 05   | 43650-0509   | 43650-0510   | 43650-0511   |
| 06   | 43650-0609   | 43650-0610   | 43650-0611   |
| 07   | 43650-0709   | 43650-0710   | 43650-0711   |
| 08   | 43650-0809   | 43650-0810   | 43650-0811   |
| 09   | 43650-0909   | 43650-0910   | 43650-0911   |
| 10   | 43650-1009   | 43650-1010   | 43650-1011   |
| 11   | 43650-1109   | 43650-1110   | 43650-1111   |
| 12   | 43650-1209   | 43650-1210   | 43650-1211   |

RECEPTACLE #43645

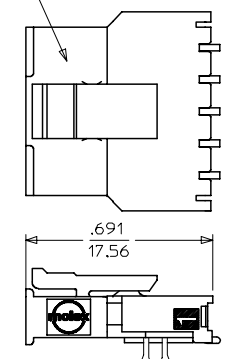

MATED MICRO FIT CONNECTORS

|   |                               |                                       |      |                              |                    |  |                        |                        |
|---|-------------------------------|---------------------------------------|------|------------------------------|--------------------|--|------------------------|------------------------|
| ADD NOTES 8 AND 9<br>EC NO: UCP2008-0037<br>DRAWN:MK/PPER 2007/09/06<br>CHKD:SSOUSEK 2007/09/11<br>APPR:FSM/TH 2007/09/12     | QUALITY SYMBOLS<br>▽=0<br>▽=0 | GENERAL TOLERANCES (UNLESS SPECIFIED) |      | DIMENSION STYLE<br>IN/MM     |                    | SCALE<br>---   | DESIGN UNITS<br>METRIC | THIRD ANGLE PROJECTION |
|   |                               | mm                                    | INCH | DRAWN BY<br>SAMIEC           | DATE<br>2000/07/07 | TITLE<br>MICRO FIT (3.0)<br>SINGLE ROW / RIGHT ANGLE<br>SMT / CLIPS / REEL | MOLEX INCORPORATED     |                        |
| DRAFT WHERE APPLICABLE<br>MUST REMAIN<br>WITHIN DIMENSIONS  |                               | SEE CHART                             |      | MATERIAL NO.<br>SD-43650-004 |                    | DOCUMENT NO.   |                        | SHEET NO.<br>1 OF 1    |
| THIS DRAWING CONTAINS INFORMATION THAT IS PROPRIETARY TO MOLEX INCORPORATED AND SHOULD NOT BE USED WITHOUT WRITTEN PERMISSION |                               |                                       |      |                              |                    |  |                        |                        |

12 11 10 9 8 7 6 5 4 3 2 1