

**PLEASE CHECK WWW.MOLEX.COM FOR LATEST PART INFORMATION**

**Part Number:** [0739427100](#)  
**Status:** **Active**  
**Overview:** [hdm](#)  
**Description:** 2.00mm (.079") Pitch HDM® Board-to-Board Backplane Header, Vertical, Solder Tail, Open End, 144 Circuits

**Documents:**

[Drawing \(PDF\)](#) [RoHS Certificate of Compliance \(PDF\)](#)

**Agency Certification**

CSA LR19980  
 UL E29179

**General**

Product Family Backplane Connectors  
 Series [73942](#)  
 Application Backplane  
 Component Type PCB Header  
 Overview [hdm](#)  
 Product Name HDM®  
 Style N/A

**Physical**

Circuits (Loaded) 144  
 Circuits (maximum) 144  
 Color - Resin Black, Natural  
 Durability (mating cycles max) 250  
 First Mate / Last Break No  
 Flammability 94V-0  
 Guide to Mating Part No  
 Keying to Mating Part None  
 Material - Metal Phosphor Bronze  
 Material - Plating Mating Gold  
 Material - Plating Termination Tin  
 Material - Resin High Temperature Thermoplastic  
 Number of Columns 24  
 Number of Pairs Open Pin Field  
 Number of Rows 6  
 Orientation Vertical  
 PC Tail Length (in) 0.138 In  
 PC Tail Length (mm) 3.50 mm  
 PCB Locator No  
 PCB Retention None  
 PCB Thickness Recommended (in) 0.098 In  
 PCB Thickness Recommended (mm) 2.50 mm  
 Packaging Type Tube  
 Pitch - Mating Interface (in) 0.079 In  
 Pitch - Mating Interface (mm) 2.00 mm  
 Pitch - Term. Interface (in) 0.079 In  
 Pitch - Term. Interface (mm) 2.00 mm  
 Plating min: Mating (µin) 30  
 Plating min: Mating (µm) 0.75  
 Plating min: Termination (µin) 100  
 Plating min: Termination (µm) 2.5  
 Polarized to PCB No  
 Stackable No

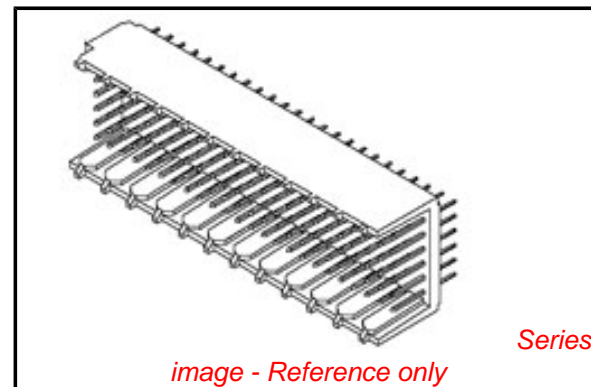

**EU RoHS**

**ELV and RoHS  
 Compliant  
 REACH SVHC  
 Not Reviewed  
 Halogen-Free  
 Status  
 Not Reviewed**

**China RoHS**



**Need more information on product environmental compliance?**

Email [productcompliance@molex.com](mailto:productcompliance@molex.com)  
 For a multiple part number RoHS Certificate of Compliance, [click here](#)

Please visit the [Contact Us](#) section for any non-product compliance questions.

**Search Parts in this Series**

[73942Series](#)

**Mates With**

[73632](#) HDM PLUS® Board-to-Board Daughtercard Receptacle. [73780](#) HDM® Board-to-Board Daughtercard Receptacle

**Application Tooling | FAQ**

*Tooling specifications and manuals are found by selecting the products below. Crimp Height Specifications are then contained in the Application Tooling Specification document.*

**Global**

Description	Product #
HDM® Backplane	<a href="#">0621001400</a>
Insertion Signal	
Contact Tool	
Extraction Tool	<a href="#">0621001000</a>

Surface Mount Compatible (SMC)	Yes
Temperature Range - Operating	-55°C to +105°C
Termination Interface: Style	Through Hole

### **Electrical**

Current - Maximum per Contact	1A
Data Rate	1.0 Gbps
Real Signals (per 25mm)	75
Shielded	No
Voltage - Maximum	250V AC

### **Material Info**

#### **Reference - Drawing Numbers**

Packaging Specification	PK-70873-0818
Sales Drawing	SD-73942-001

HDM and High Density Metric are trademarks of Amphenol Corporation

This document was generated on 05/14/2010

**PLEASE CHECK [WWW.MOLEX.COM](http://WWW.MOLEX.COM) FOR LATEST PART INFORMATION**

**NOTES:**

1. MATERIALS: HOUSING--LIQUID CRYSTAL POLYMER (LCP), GLASS FILLED, UL94V-0, COLOR: BLACK, TERMINAL: PHOSPHOR BRONZE.
2. FINISH: 0.75 MICROMETERS MINIMUM SELECTIVE GOLD (Au) IN MATING AREA; 2.50 MICROMETERS MINIMUM SELECTIVE TIN (Sn) IN TAIL AREA; NICKEL (Ni) UNDERPLATE OVERALL.
3. THIS PART CONFORMS TO MOLEX PRODUCT SPECIFICATION PS-73670-9999.
4. FOR MIXED CONTACT MATING LENGTHS, CONSULT FACTORY FOR AVAILABILITY.
5. PACKAGE PER PK-70873-0818.
6. PARTS MARKED WITH PART NUMBER AND DATE CODE, ON EITHER SIDE, APPROXIMATELY WHERE SHOWN.

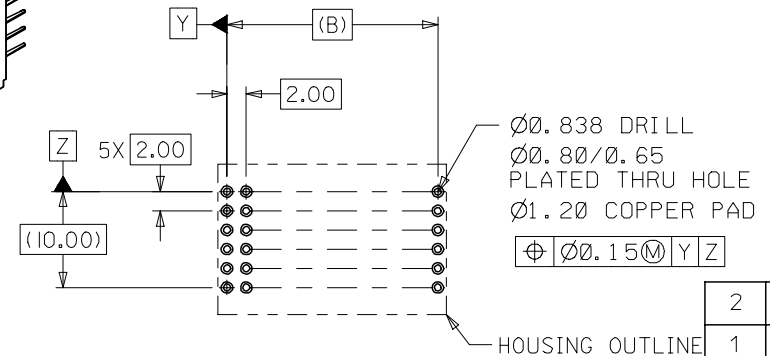
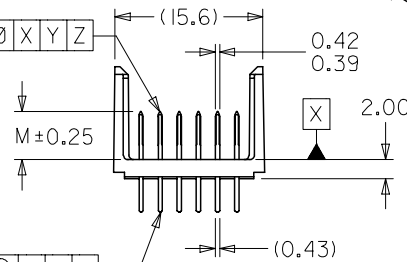
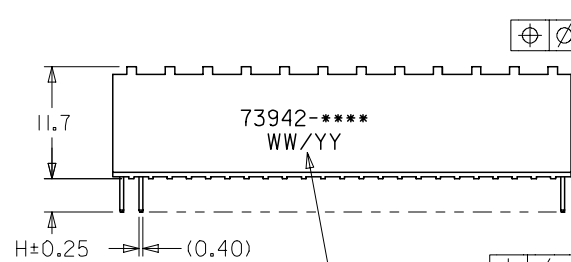
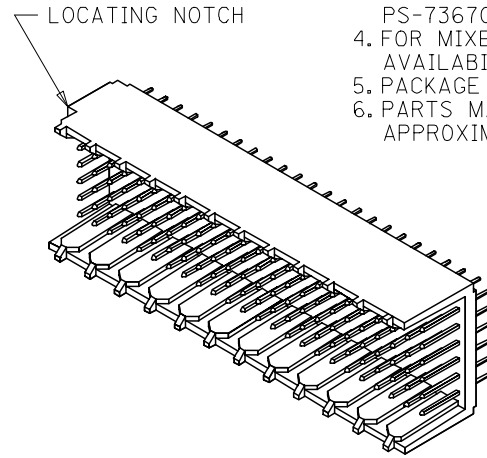
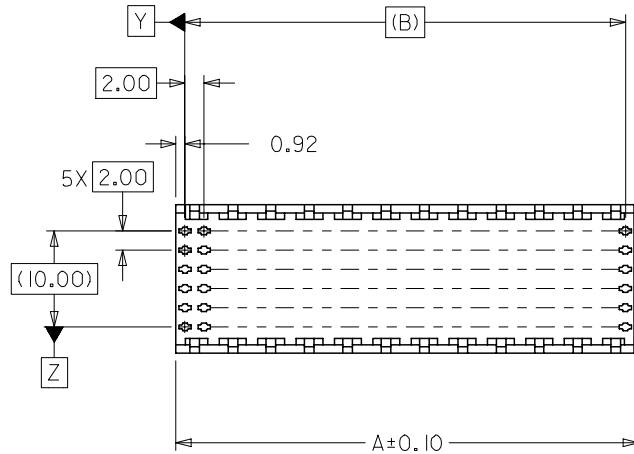

PCB LAYOUT: COMPONENT SIDE  
RECOMMENDED PCB THICKNESS: 2.50 MIN.

2	A
1	G
SHT	REV

SEE NOTE 6

MODIFY FINISH NOTE	QUALITY SYMBOLS
EC NO: UCP2007-2259	▽=0
IDRW:MSIBARRA 2007/03/13	▽=0
CHKD:BBARKER 2007/03/21	
APPR:SMILLER 2007/03/22	
DESCRIPTION	
REV	

GENERAL TOLERANCES (UNLESS SPECIFIED)

	mm	INCH
4 PLACES	± ---	± ---
3 PLACES	± ---	± ---
2 PLACES	± 0.05	± ---
1 PLACE	± 0.10	± ---
ANGULAR ±1/2°		

DIMENSION STYLE  
MM ONLY

DRAWN BY	DATE
JB INGHAM	1998/01/13
CHECKED BY	DATE
SREED	1998/01/13
APPROVED BY	DATE
CBIXLER	1998/01/13
MATERIAL NO.	
SEE CHART	

SCALE  
2:1

TITLE  
SALES ASSY HDM BACKPLANE  
OPEN END OPTION  
SOLDER TAIL VERSION

DESIGN UNITS  
METRIC

THIRD ANGLE PROJECTION

MOLEX INCORPORATED

DOCUMENT NO.  
SD-73942-001

DRAFT WHERE APPLICABLE  
MUST REMAIN WITHIN DIMENSIONS



THIS DRAWING CONTAINS INFORMATION THAT IS PROPRIETARY TO MOLEX INCORPORATED AND SHOULD NOT BE USED WITHOUT WRITTEN PERMISSION

## MATERIAL NUMBER ASSIGNMENT

73942-\* \* 0 0

NUMBER	CIRCUIT SIZE	DIM "A"	DIM "B"	DIM "H"
0	72	23.84	22.00	2.0
1	144	47.84	46.00	2.0
2	72	23.84	22.00	2.5
3	144	47.84	46.00	2.5
4	72	23.84	22.00	3.0
5	144	47.84	46.00	3.0
6	72	23.84	22.00	3.5
7	144	47.84	46.00	3.5

NUMBER	DIM "M"
0	5.0
1	5.5
2	6.0

SEE SHEET 1 EC No. U81577 DRWN:JBINGHAM 98/0203 CHK: SREED 98/0203 APPR:CBIXLER 98/0203	MAJOR  CRITICAL 	QUALITY SYMBOLS	GENERAL TOLERANCES: (UNLESS SPECIFIED)	SCALE ---:--	DESIGN UNITS <input checked="" type="checkbox"/> mm <input type="checkbox"/> INCH	DIMENSIONS: <input type="checkbox"/> mm <input type="checkbox"/> INCH <input checked="" type="checkbox"/> mm ONLY	SHT REV		
		DRAWN BY & DATE JBINGHAM 98/01/13	THIRD ANGLE PROJECTION 		CHECKED BY & DATE SREED 98/01/13		REVISION ON CAD ONLY		
		APPROVED BY & DATE CBIXLER 98/01/13	TITLE: SALES ASSY, HDM BACKPLANE OPEN END OPTION SOLDER TAIL VERSION						
		CAD FILENAME S73942X2.DGN	MATERIAL NO. SEE CHART	DRAWING NO. SD-73942-001	SHEET NO. 2	THIS DRAWING CONTAINS INFORMATION THAT IS PROPRIETARY TO MOLEX INCORPORATED AND SHOULD NOT BE USED WITHOUT WRITTEN PERMISSION.			