

Model No.	OST10WG13GD-XXXXS1C1A
REV.	C1

PRODUCT SPECIFICATION FOR **LED Light Module**

Descriptions:

- Low power consumption, high intensity
- Long life, easy installation
- Voltages available 12VDC
- LED quantity: 13pcs 3528 SMD
- LED model number: OSXXXXS1C1A

Features:

- Available in red, orange, yellow, green, blue, white
- Directly use on line voltage
- Low power consumption, high intensity
- Energy saving
- Excellent beam control
- Long life

Application:

- Channel letter signs
- Indirect accent décor light
- Under counter light
- Automobile Light
- Substitute neon light

Product Picture:





Model No.	OST10WG13GD-XXXXS1C1A
REV.	C1

Device Selection Guide

Module No.	Color	Dom. Wavelength(Typ.)	Condition	Luminous Flux / Per LED(Typ.)
R5PAS1C1A	Red	625±5nm	IF=20mA	1.5 lm
O5GAS1C1A	Orange	605±5nm	IF=20mA	1.5 lm
Y5PAS1C1A	Yellow	590±5nm	IF=20mA	1.5 lm
G5DAS1C1A	Green	525±5nm	IF=20mA	3.0 lm
B5SAS1C1A	Blue	470±5nm	IF=20mA	1.0 lm
W44LS1C1A	White	X=0.31 ; Y=0.33	IF=20mA	7.0 lm
M54LS1C1A	Warm White	X=0.45 ; Y=0.41	IF=20mA	6.0 lm
K5DLS1C1A	Pink	X=0.45 ; Y=0.17	IF=20mA	0.5 lm

Absolute Maximum Ratings(Ta=25)

Items	Symbol	Values	Units
Operating Supply Range(DC)	V _{dc}	14	V
Input Current (DC)	I _i	125	mA
Power Dissipation	P _a	1.75	W
LED Light Source Temperature	T _{led}	105	DegC
Operating Temperature	T _{ope}	-20 ~ +75	DegC
Storage Temperature	T _{sto}	-20 ~ +80	DegC

Typical Performance (Ta=25)

Items	Symbol	Min.	Typ.	Max.	Units
LED Module Power	P _m	-	1.2	1.75	w
Input Voltage(DC)	V _i	-	12	14	V
Product Input Current	I _f	-	100	125	mA
Beam Pattern	BP	-	120	-	Deg
Modules Size	Size.	-	37*9.18	-	mm
Net Weight	Wei.	-	2.7	-	g

Model No.	OST10WG13GD-XXXXS1C1A
REV.	C1

Product Dimensions:

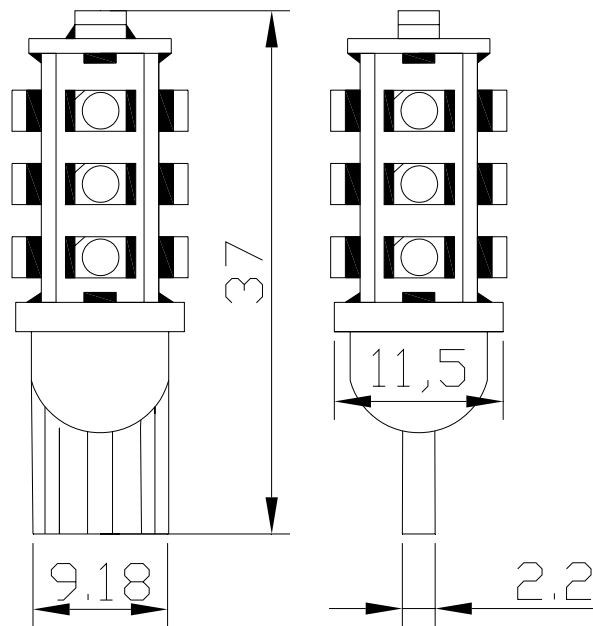
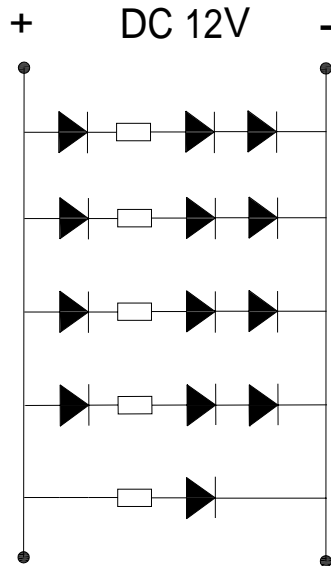

Unit: mm
Tolerance: $\pm 0.30\text{mm}$