

WDD15 SERIES

DC - DC CONVERTER
12 ~ 15W SINGLE & DUAL OUTPUT



FEATURES

- EFFICIENCY UP TO 84%
- 4:1 WIDE INPUT RANGE
- I/O ISOLATION
- INPUT Pi FILTER
- SHORT CIRCUIT PROTECTION
- HIGH PERFORMANCE
- 2 YEARS WARRANTY

MODEL LIST

MODEL NO.	INPUT VOLTAGE	INPUT CURRENT (typ.)	OUTPUT WATTAGE	OUTPUT VOLTAGE	OUTPUT CURRENT	EFF. (min.)	EFF. (typ.)	CAPACITOR LOAD (max.)
Single Output Models								
WDD15 - 03S4	10~36 VDC	0.63 A	12 WATTS	+3.3 VDC	3600 mA	77%	80%	7000 μ F
WDD15 - 05S4	10~36 VDC	0.78 A	15 WATTS	+ 5 VDC	3000 mA	79%	81%	7000 μ F
WDD15 - 12S4	10~36 VDC	0.75 A	15 WATTS	+ 12 VDC	1250 mA	81%	83%	470 μ F
WDD15 - 15S4	10~36 VDC	0.75 A	15 WATTS	+ 15 VDC	1000 mA	81%	83%	220 μ F
WDD15 - 03S5	18~72 VDC	0.32 A	12 WATTS	+3.3 VDC	3600 mA	77%	80%	7000 μ F
WDD15 - 05S5	18~72 VDC	0.39 A	15 WATTS	+ 5 VDC	3000 mA	79%	81%	7000 μ F
WDD15 - 12S5	18~72 VDC	0.37 A	15 WATTS	+ 12 VDC	1250 mA	82%	84%	470 μ F
WDD15 - 15S5	18~72 VDC	0.38 A	15 WATTS	+ 15 VDC	1000 mA	80%	82%	220 μ F
Dual Output Models								
WDD15 - 12D4	10~36 VDC	0.78 A	15 WATTS	\pm 12 VDC	\pm 630 mA	80%	82%	\pm 1000 μ F
WDD15 - 15D4	10~36 VDC	0.78 A	15 WATTS	\pm 15 VDC	\pm 500 mA	79%	81%	\pm 1000 μ F
WDD15 - 12D5	18~72 VDC	0.39 A	15 WATTS	\pm 12 VDC	\pm 630 mA	80%	82%	\pm 1000 μ F
WDD15 - 15D5	18~72 VDC	0.38 A	15 WATTS	\pm 15 VDC	\pm 500 mA	79%	81%	\pm 1000 μ F

SPECIFICATION

All Specifications Typical At Nominal Line, Full Load, 25°C Unless Otherwise Noticed

GENERAL

Characteristics	Conditions	min.	typ.	max.	unit
Switching frequency	Vi nom, Io nom		230		KHz
Isolation voltage	Input - Output	1500			VDC
Isolation resistance	Input - Output, @ 500VDC	100			MΩ
Isolation capacitance	100KHz / 1V			1000	PF
Ambient temperature	Vi nom, 3.3V & 5V output models	-25		+ 61	°C
	Io nom 12V, 15V & dual output models	-25		+ 71	°C
Case temperature	Operating at Vi nom, Io nom			+ 100	°C
Derating	Vi nom	See derating curve			
Storage temperature	Non operational	-40		+ 100	°C
Relative humidity	Vi nom, Io nom	20		95	% RH
Temperature coefficient	Vi nom, Io min			± 0.02	% / °C
Dimension		L50.8 x W40.64 x H10.16			mm
MTBF	Belcore issue 6@40°C, GB		1270000		Hours
Cooling	Free air convection				

INPUT SPECIFICATIONS

Characteristics	Conditions	min.	typ.	max.	unit
Input voltage range	Ta min ... Ta max, Io nom	10	24	36	VDC
		18	48	72	VDC
No load input current	Vi nom, Io = 0	24V models		15	mA
		48V models		10	mA
Input voltage w/o damage	Io nom	24V models		40	VDC
		48V models		75	VDC
Startup voltage	Io nom	24V models	9.5		VDC
		48V models		16	VDC
Input filter	Pi type				

OUTPUT SPECIFICATIONS

Characteristics	Conditions	min.	typ.	max.	unit
Output voltage accuracy	Vi nom, Io nom			± 2	%
Minimum load	Vi nom single output models	0			%
	Vi nom dual output models (each output)	10			%
Line regulation	Io nom, Vi min ... Vi max			± 1	%
Load regulation	Vi nom, Io 0 ... Io nom, single output models			± 2	%
	Vi nom, Io min ... Io nom, dual output models			± 5	%
Cross regulation (Dual model)	Aymmetrical load 10% - 100% FL			± 5	%
Startup time	Vi nom, Io nom			30	ms
Transient recovery time	Vi nom, 1 ~ 0.5 Io nom			500	μs
Ripple & noise	Vi nom, Io nom, BW = 20MHz	3.3V & 5V models		100	mV
		12V, 15V & dual		150	mV
Voltage trim range I)	Vi nom	3.3V model	± 5		%
		5V, 12V, 15V & dual	± 10		%
Efficiency	Vi nom, Io nom, Po / Pi	Up to 84%, See model list and efficiency curve			

NOTE 1 : Pls refer to Fig 1 & Table 1 for connection and resistance recommended.

CONTROL AND PROTECTION

Remote ON / OFF	ON : opened or 8 ~ 10VDC applied, reference to input GND OFF : -0.3 ~ 2VDC applied, reference to input GND
Input reversed	Shunt diode built in, external fuse recommended (24Vin : 2A, 48Vin : 1A)
Output short circuit	Current limited (Auto-recovery)
Rated over load protection	110%min....140%max

PHYSICAL CHARACTERISTICS

Case size	50.8 x 40.64 x 10.16 mm (2 x 1.6 x 0.4 inches)
Case material	Plastic base / Metal case
Weight	60 g
Patting material	Epoxy

MECHANISM & PIN CONFIGURATION

mm [inch]

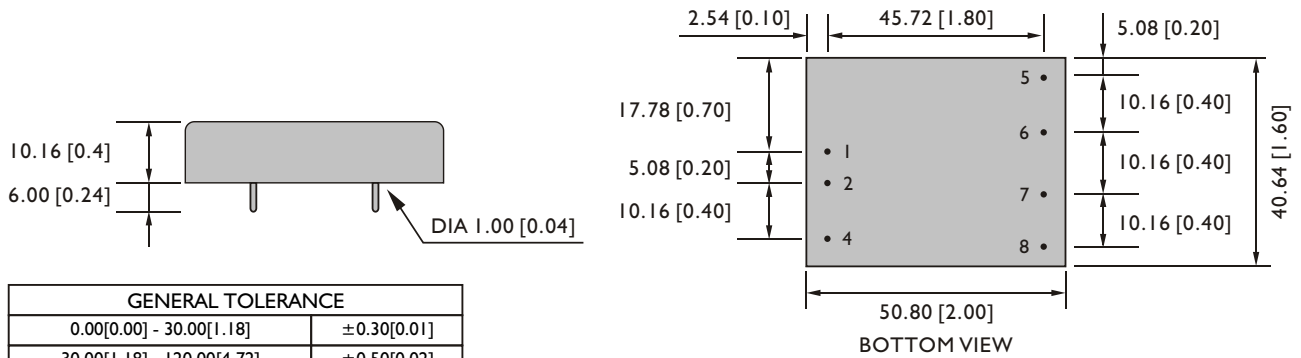

PIN ASSIGNMENT

GENERAL

PIN NO.	1	2	4	5	6	7	8
SINGLE	Vi +	Vi -	ON / OFF	NO PIN	Vo +	Vo -	Trim
DUAL	Vi +	Vi -	ON / OFF	Vo +	com	Vo -	Trim

CIRCUIT SCHEMATIC

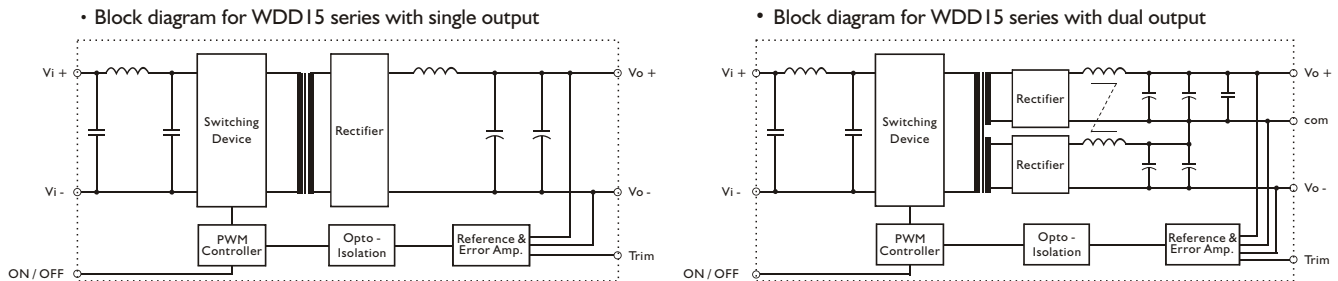

RECOMMENDED CIRCUIT

• Recommended filter for EN55022 Class B compliance

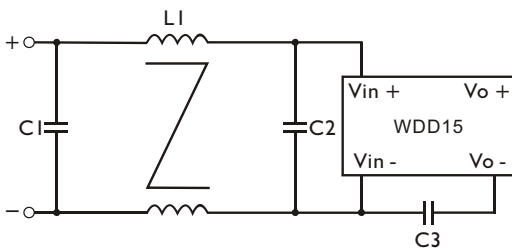

• The components used in the above figure, together with the manufacturer part numbers for these components, are as follows.

	C1	C2	C3	L1
WDD15-XXX4	1 μ F / 50V MLCC	1 μ F / 50V MLCC	1nF / 2KV MLCC	1.5mH Common Choke
WDD15-XXX5	3.3 μ F / 100V MLCC	3.3 μ F / 100V MLCC	1nF / 2KV MLCC	3.5mH Common Choke

• Recommended EN 55022 Class B filter circuit layout.

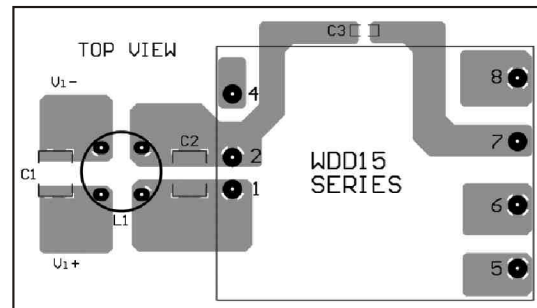

DERATING AND EFFICIENCY CURVE

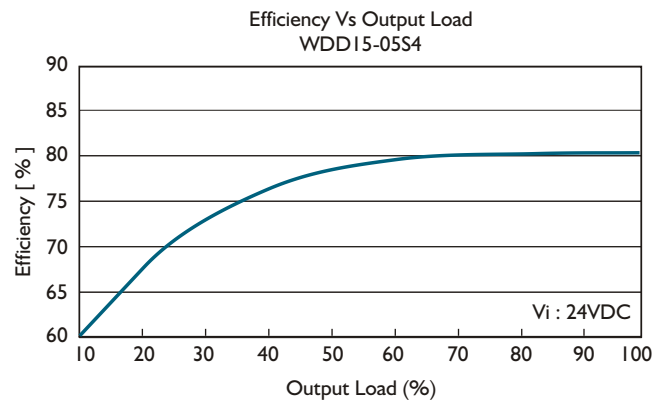
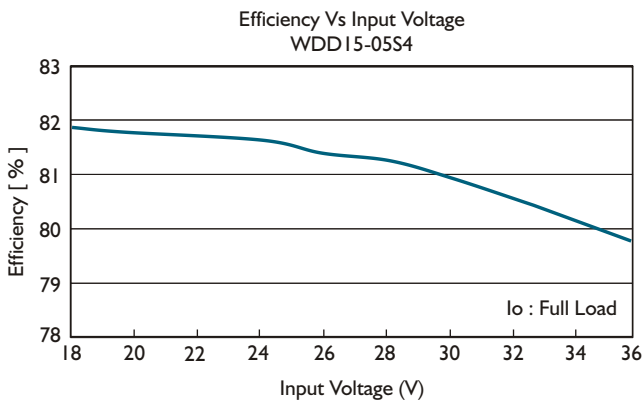
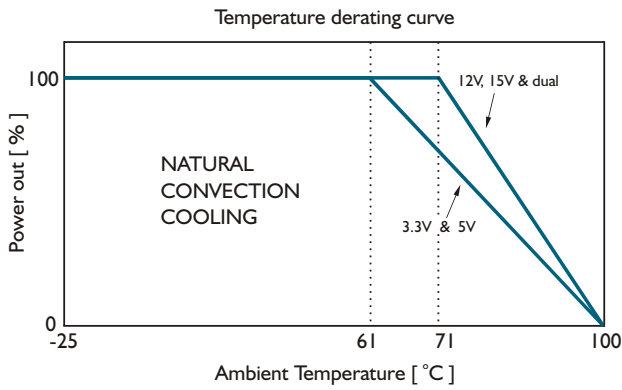
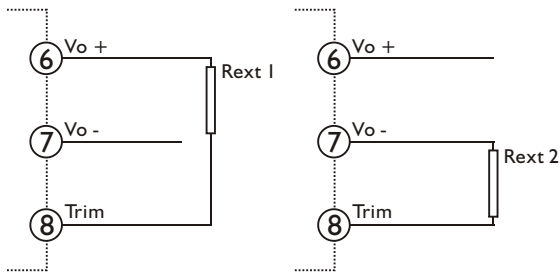

Fig. 1 Trim connection

(For Single output)



(For Dual output)

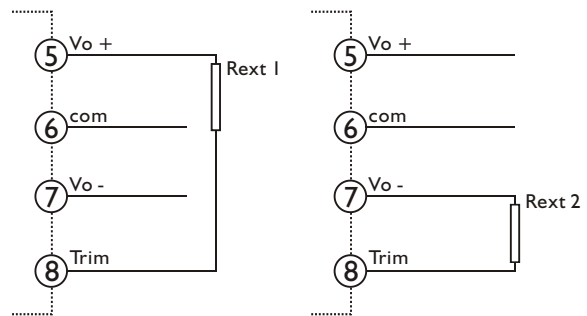

Table 1 Typical resistor values for various output voltage adjustment settings

Type	Rext 1		Rext 2	
	Vo nom -2.5%	Vo nom -5%	Vo nom +2.5%	Vo nom +5%
WDD15-03SX	750Ω	510Ω	8.66KΩ	3.9KΩ
Type	Vo nom -5%	Vo nom -10%	Vo nom +5%	Vo nom +10%
WDD15-05SX	4.7KΩ	0Ω	4.7KΩ	470Ω
WDD15-12SX	47KΩ	15KΩ	5.6KΩ	200Ω
WDD15-15SX	150KΩ	56KΩ	12KΩ	1KΩ
WDD15-12DX	130KΩ	51KΩ	10KΩ	750Ω
WDD15-15DX	330KΩ	150KΩ	20KΩ	3KΩ