

# ADJUSTABLE PRECISION ZENER SHUNT REGULATOR

ISSUE 5 – DECEMBER 2002

ZR431

## DEVICE DESCRIPTION

The ZR431 is a three terminal adjustable shunt regulator offering excellent temperature stability and output current handling capability up to 100mA. The output voltage may be set to any chosen voltage between 2.5 and 20 volts by selection of two external divider resistors.

The devices can be used as a replacement for zener diodes in many applications requiring an improvement in zener performance.

## FEATURES

- Surface mount SOT223 and SOT23 packages
- TO92 package
- 2%, 1 % and 0.5% tolerance
- Max. temperature coefficient 55 ppm/°C
- Temperature compensated for operation over the full temperature range
- Programmable output voltage
- 50µA to 100mA current sink capability
- Low output noise

## APPLICATIONS

- Shunt regulator
- Series regulator
- Voltage monitor
- Over voltage/ under voltage protection
- Switch mode power supplies

## SCHEMATIC DIAGRAM

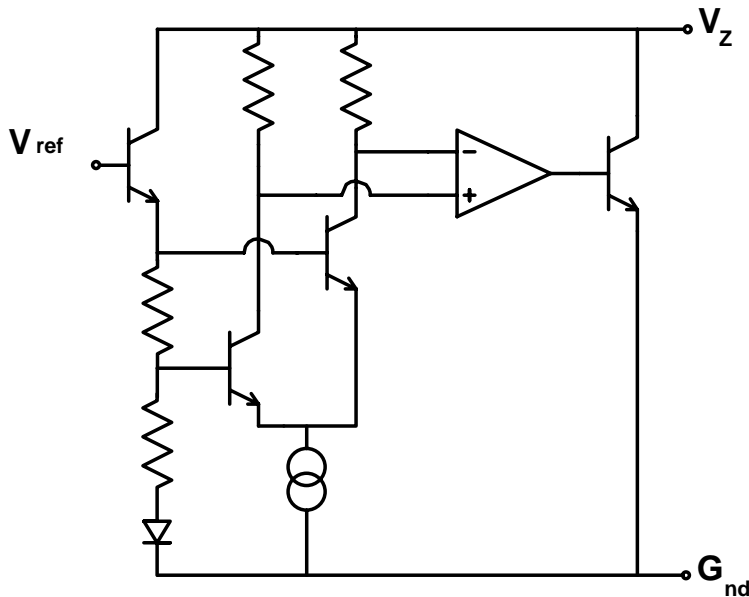

# ZR431

## ABSOLUTE MAXIMUM RATING

Cathode Voltage ( $V_Z$ )	20V	<b>Power Dissipation</b> ( $T_{amb}=25^{\circ}C, T_{jmax}=150^{\circ}C$ )	
Cathode Current	150mA	SOT23	330mW
Operating Temperature	-40 to $85^{\circ}C$	TO92	780mW
Storage Temperature	-55 to $125^{\circ}C$	SOT223	2W

## Recommended Operating Conditions

	Min	Max
Cathode Voltage	$V_{ref}$	20V
Cathode Current	$50\mu A$	100mA

## ELECTRICAL CHARACTERISTICS TEST CONDITIONS (Unless otherwise stated): $T_{amb}=25^{\circ}C$

PARAMETER	SYMBOL	VALUE			UNITS	CONDITIONS
		MIN	TYP	MAX		
Reference Voltage	$V_{ref}$	2.45	2.50	2.55	V	$I_L=10mA$ (Fig1), $V_Z=V_{ref}$
		2.475	2.50	2.525		
		2.487	2.50	2.513		
Deviation of Reference Input Voltage over Temperature	$V_{dev}$		8.0	17	mV	$I_L=10mA, V_Z=V_{ref}$ $T_a=full\ range$ (Fig1)
Ratio of the change in Reference Voltage to the Change in Cathode Voltage	$\frac{\Delta V_{ref}}{\Delta V_Z}$		-1.85	-2.7	mV/V	$V_Z$ from $V_{ref}$ to 10V $I_Z=10mA$ (Fig2)
			-1.0	-2.0	mV/V	$V_Z$ from 10V to 20V $I_Z=10mA$ (Fig2)
Reference Input Current	$I_{ref}$		0.12	1.0	$\mu A$	$R1=10k, R2=O/C, I_L=10mA$ (Fig2)
Deviation of Reference Input Current over Temperature	$\Delta I_{ref}$		0.04	0.2	$\mu A$	$R1=10k, R2=O/C, I_L=10mA$ $T_a=full\ range$ (Fig2)
Minimum Cathode Current for Regulation	$I_{Zmin}$		35	50	$\mu A$	$V_Z=V_{ref}$ (Fig1)
Off-state Current	$I_{Zoff}$			0.1	$\mu A$	$V_Z=20V, V_{ref}=0V$ (Fig3)
Dynamic Output Impedance	$R_Z$			0.75	$\Omega$	$V_Z=V_{ref}$ (Fig1), $f=0Hz$

<sup>(1)</sup> 0.5% SOT23 only.

For definitions of reference voltage temperature coefficient and dynamic output impedance see NOTES following DC TEST CIRCUITS



# ZR431

## TYPICAL CHARACTERISTICS

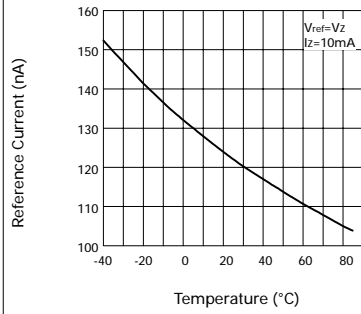

Reference Current v Temperature

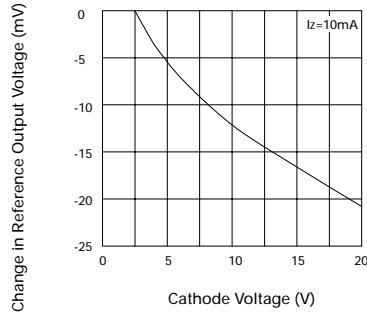

Change in Vref v Cathode Voltage

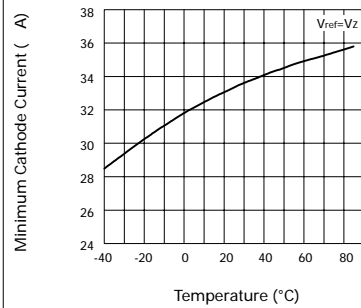

Cathode Current v Temperature

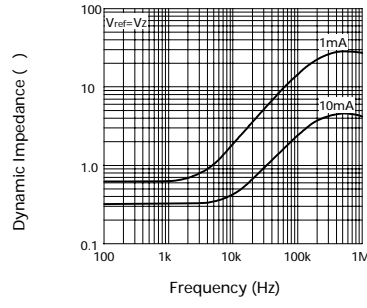

Dynamic Impedance v Frequency

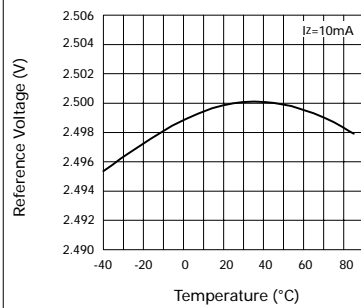

Reference Voltage v Temperature

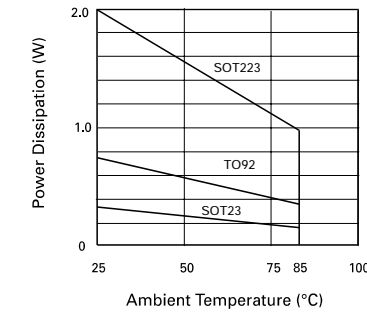

Power Dissipation Derating

# ZR431

## TYPICAL CHARACTERISTICS

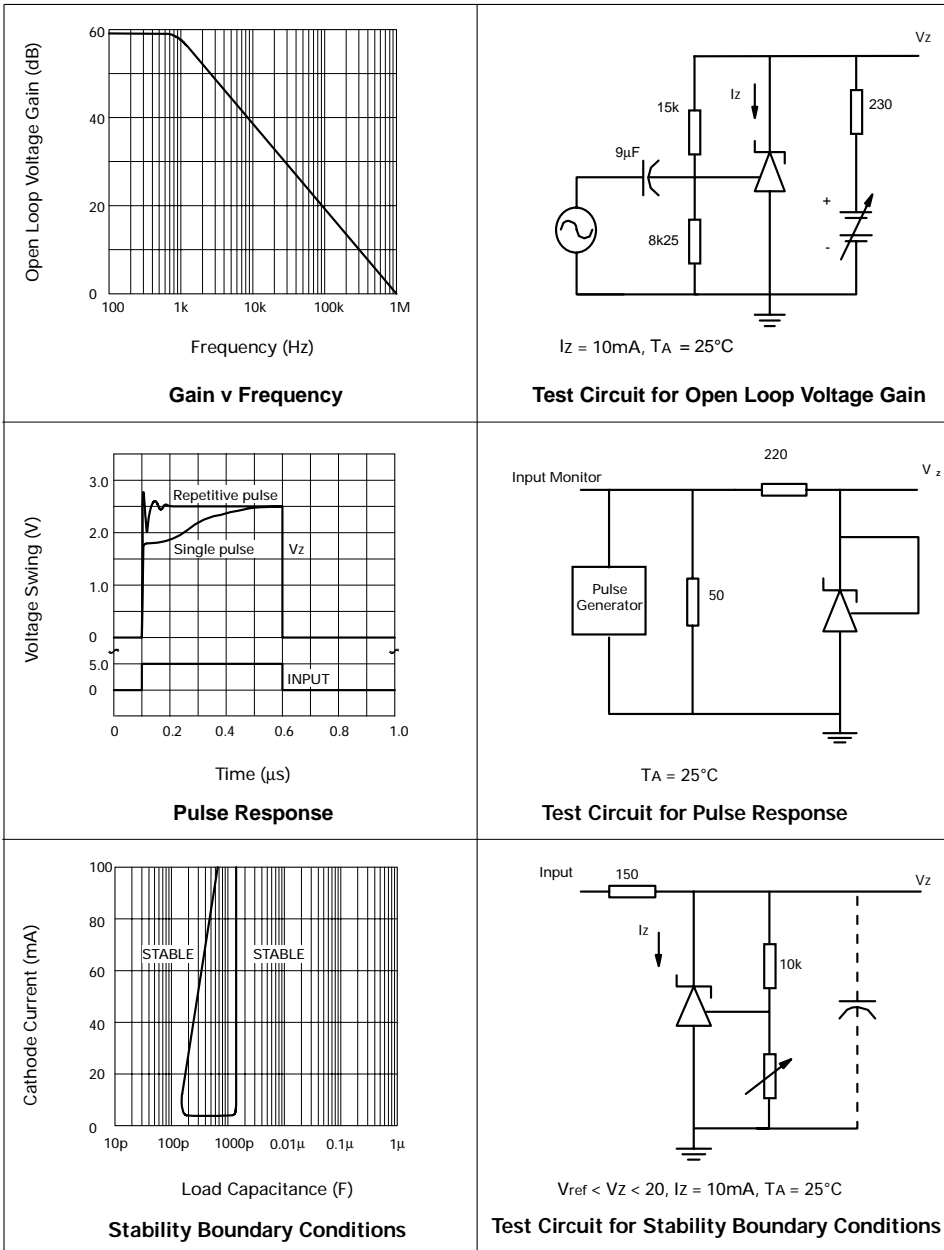

# ZR431

## APPLICATION CIRCUITS

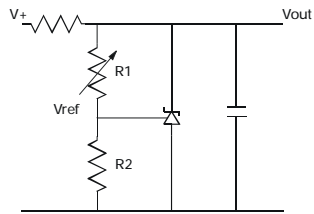

$$V_{out} = \left(1 + \frac{R1}{R2}\right) V_{ref}$$

SHUNT REGULATOR

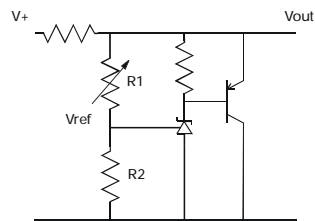

$$V_{out} = \left(1 + \frac{R1}{R2}\right) V_{ref}$$

HIGHER CURRENT SHUNT REGULATOR

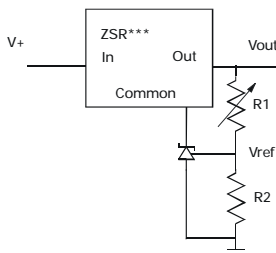

$$V_{out,MIN} = V_{ref} + V_{reg}$$

$$V_{out} = \left(1 + \frac{R1}{R2}\right) V_{ref}$$

OUTPUT CONTROL OF A THREE TERMINAL FIXED REGULATOR

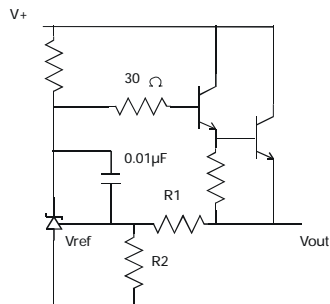

$$V_{out} = \left(1 + \frac{R1}{R2}\right) V_{ref}$$

SERIES REGULATOR

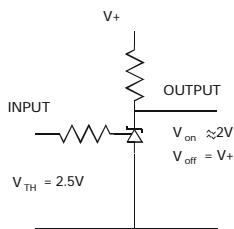

SINGLE SUPPLY COMPARATOR WITH TEMPERATURE COMPENSATED THRESHOLD

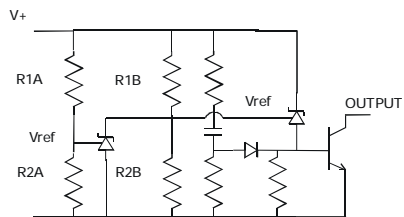

$$\text{Low limit} = \left(1 + \frac{R1B}{R2B}\right) V_{ref}$$

$$\text{High limit} = \left(1 + \frac{R1A}{R2A}\right) V_{ref}$$

OVER VOLTAGE / UNDER VOLTAGE PROTECTION CIRCUIT

# ZR431

## DC TEST CIRCUITS

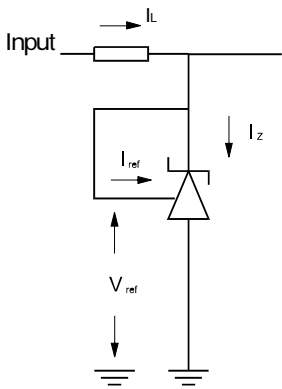

Fig 1 - Test Circuit for  $V_z = V_{ref}$

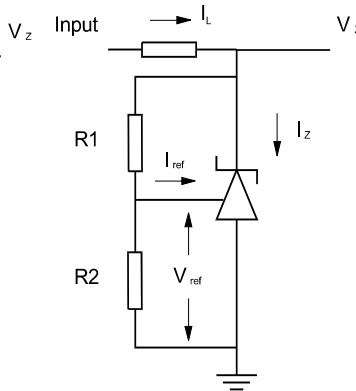

Fig 2 - Test Circuit for  $V_z > V_{ref}$

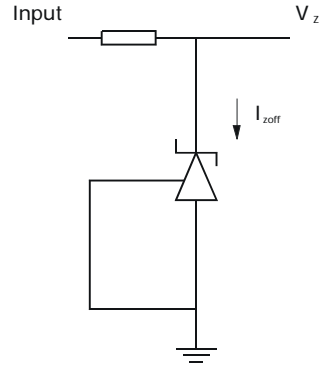
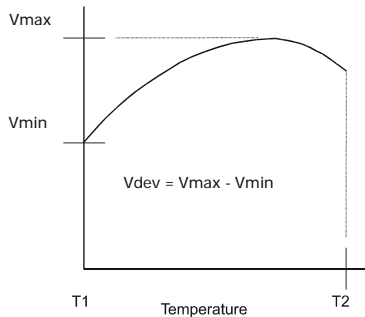

Fig 3 - Test Circuit for Off State current

## NOTES

Deviation of reference input voltage,  $V_{dev}$ , is defined as the maximum variation of the reference input voltage over the full temperature range.

The average temperature coefficient of the reference input voltage,  $V_{ref}$  is defined as:



$$V_{ref} (ppm/^{\circ}C) = \frac{V_{dev} \times 1000000}{V_{ref} (T1 - T2)}$$

The dynamic output impedance,  $R_z$ , is defined as:

$$R_z = \frac{\Delta V_z}{\Delta I_z}$$

When the device is programmed with two external resistors,  $R_1$  and  $R_2$ , (fig 2), the dynamic output impedance of the overall circuit,  $R'$ , is defined as:

$$R' = R_z \left(1 + \frac{R_1}{R_2}\right)$$

# ZR431

## CONNECTION DIAGRAMS

### TO92 Package Suffix - C

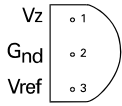

Bottom View

### SOT223 Package Suffix - G

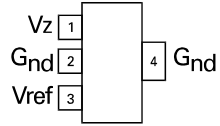

Top View -  
Pin 4 floating or connected to pin 2

### SOT23 Package Suffix - F

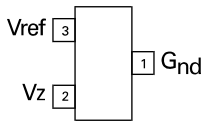

Top View

## ORDERING INFORMATION

Part Number	Package	Tol. %	Part Mark
ZR431C01	TO92	1.0	ZR43101
ZR431C	TO92	2.0	ZR431
ZR431G01	SOT223	1.0	ZR43101
ZR431G	SOT223	2.0	ZR431
ZR431F005	SOT23	0.5	43R
ZR431F01	SOT23	1.0	43B
ZR431F	SOT23	2.0	43A