

## V23100-V4 series

### Dual In-line Package and Single In-line Package Dry Reed Relays

#### Features

- DIP (flat and high) and SIP versions.
- For use in measuring and control systems.
- Direct coil control with TTL-signals.
- IC pin compatible.
- Low operating noises and low thermoelectric voltage.
- Ultrasonic cleanable.
- High vibration and shock resistance.

#### Contact Data @ 25°C

Type of Relay	DIP Version		SIP Version
Type of Contacts	SPST, 1 Form A DPST, 2 Form A	SPDT, 1 Form C	SPST, 1 Form A
Max. Switch. Current	0.5A	0.25A	0.5A
Max. Continuous Current	1A	1.2A	1A
Max. Switch. Voltage @ nominal voltage			
5VDC	180VDC/MAC	175VDC	180VDC/MAC
12-24VDC	200VDC/MAC		200VDC/MAC
Max. Switch. Capacity			
VDC	10W	3W	10W
VAC	10VA	3VA	10VA
Expected Mech. Life	5 Million Ops.	4 Million Ops.	5 Million Ops.
Initial Contact Resist.	150mΩ @ 10Ma/20mV		

#### Initial Dielectric Strength

Between Form A Contacts: 250VDC (12V-24V coils), 210VDC (5V coils).  
 Form C Contacts: 200VDC.  
 Between Coil and Contacts: 1,500VDC.

#### Initial Insulation Resistance

Between Mutually Insulated Conductors: 10<sup>11</sup> ohms @ 500VDC.

#### Coil Data @ 25°C

Nominal Voltage: 5 to 24VDC.  
 Nominal Power: 50 - 288mW.  
 Maximum Coil Power:  
 Temperature Rise:  
 Duty Cycle:

#### Coil Data @ 20°C

Nominal Voltage (VDC)	Resistance ± 10% (Ohms)	Operating Voltage (VDC)	
		(Min.)	(Max.)
<b>DIP and SIP Version: SPST - 1 Form A</b>			
5	500	3.5	22
12	1,000	8.4	33
15	2,000	10.5	44
24	2,000	16.8	44
<b>DIP Version: DPST - 2 Form A</b>			
5	200	3.5	14
12	500	8.4	25
15	2,000	10.5	47
24	2,000	16.8	47
<b>DIP Version: SPDT - 1 Form C</b>			
5	200	3.5	13 (14)
12	500	8.4	22 (23)
15	2,000	10.5	44 (49)
24	2,000	16.8	44 (49)

\*Values in brackets refer to high relay version with protective diode.

#### Operate Data @ 20°C

Must Operate Voltage: 70% of nominal voltage.  
 Must Release Voltage: 15% of nominal voltage.

Type of Relay	DIP Version		SIP Version
Type of Contacts	SPST, 1 Form A DPST, 2 Form A	SPDT, 1 Form C	SPST, 1 Form A
Operate Time (Including Bounce)	0.5ms	0.7ms	0.5ms
Release Time (Including Bounce)	0.2ms	1.0ms	0.2ms

Operate Bounce:  
 Release Bounce:

#### Environmental Data

Temperature Range: -20°C to +70°C.  
 Vibration, Operational:  
 Shock, Operational:  
 Shock, Non-destructive:

#### Mechanical Data

Termination:  
 Enclosure:  
 Weight:

**Ordering Information**

<b>Typical Part Number ▶</b>	<b>V23100-V4</b>	<b>3</b>	<b>24</b>	<b>A</b>
<b>1. Basic Series:</b> V23100-V4 – DIL and SIP reed relay.				
<b>2. Version:</b> DIP flat package: 0 – 1 Form A contacts.      3 – 1 Form C standard and 1 Form C with electrostatical shield. DIP high package: 3 – 2 Form A contacts and 1 Form C with diode or electrostatical shield and diode. SIP package: 5				
<b>3. Coil Voltage:</b> 05 – 5VDC      12 – 12VDC      15 – 15VDC      24 – 24VDC				
<b>4. Contact Arrangement:</b> A – 1 Form A (not for high DIP).      B – 2 Form a (high DIP only).      C – 1 Form C (not for SIP).				
<b>5. Options:</b> 000 – standard.      001 – with electrostatical shield      010 – with diode.      011 – with electrostatical shield and diode.				

**Stock Items – The following items are normally maintained in stock for immediate delivery.**

V23100V4005A000	V23100V4505A000
V23100V4012A000	V23100V4517A000
V23100V4024A000	V23100V4524A000

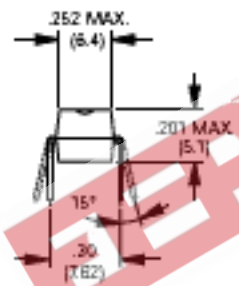
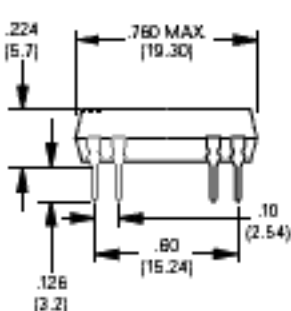
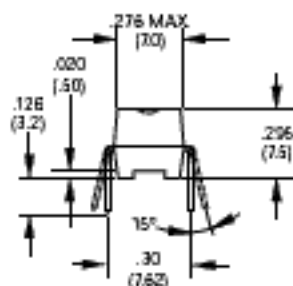
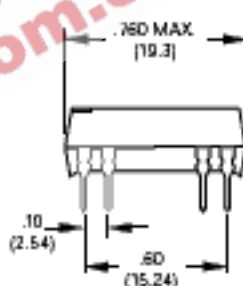
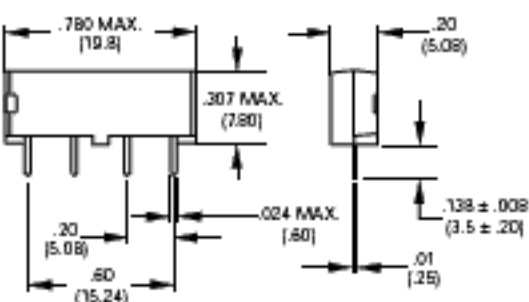
**Outline Dimensions**
**DIP Version (Flat)**

**DIP Version (High)**

**SIP Version**

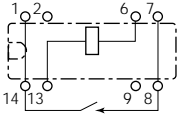
**Wiring Diagrams (Bottom Views)**  
DIP Version (Flat)

**SPST-1 Form A**  
standard

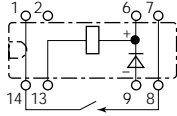

**SPST-1 Form A**  
w/diode



**SPDT-1 Form C**  
standard

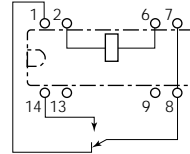

**SPST-1 Form A**  
w/electrostatic Shield

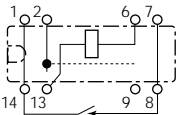

**SPST-1 Form A**  
w/electrostatic shield and diode

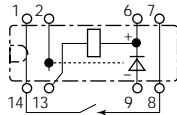

**SPDT-1 Form C**  
w/electrostatic shield

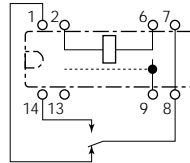

**DIP Version (High)**

**DPST-2 Form A**  
standard

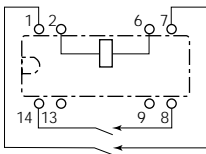

**SPDT-1 Form C**  
w/diode

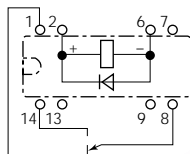

**DPST-2 Form A**  
w/diode

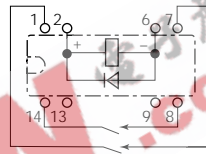

**SPDT-1 Form C**  
w/electrostatic shield and diode

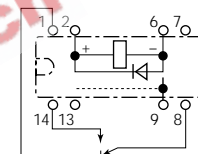

**SIP Version**

**SPST-1 Form A**  
standard

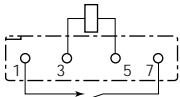

**SPST-1 Form A**  
w/diode

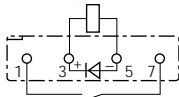

**PC Board Layouts (Bottom Views)**

**DIP Version (Flat)**

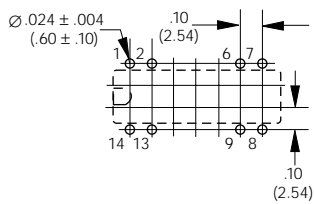

**DIP Version (High)**

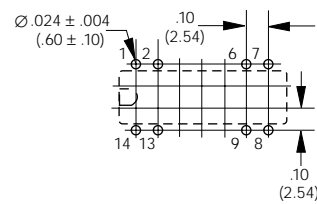

**SIP Version**

