

V23100-V4 series

Dual In-line Package and Single In-line Package Dry Reed Relays

Features

- DIP (flat and high) and SIP versions.
- For use in measuring and control systems.
- Direct coil control with TTL-signals.
- IC pin compatible.
- Low operating noises and low thermoelectric voltage.
- Ultrasonic cleanable.
- High vibration and shock resistance.

Contact Data @ 25°C

| Type of Relay | DIP Version | | SIP Version |
|--|----------------------------------|----------------|----------------|
| Type of Contacts | SPST, 1 Form A DPST, 2 Form A | SPDT, 1 Form C | SPST, 1 Form A |
| Max. Switch. Current | 0.5A | 0.25A | 0.5A |
| Max. Continuous Current | 1A | 1.2A | 1A |
| Max. Switch. Voltage @ nominal voltage | | | |
| 5VDC | 180VDC/MAC | 175VDC | 180VDC/MAC |
| 12-24VDC | 200VDC/MAC | | 200VDC/MAC |
| Max. Switch. Capacity | | | |
| VDC | 10W | 3W | 10W |
| VAC | 10VA | 3VA | 10VA |
| Expected Mech. Life | 5 Million Ops. | 4 Million Ops. | 5 Million Ops. |
| Initial Contact Resist. | 150mΩ @ 10Ma/20mV | | |

Initial Dielectric Strength

Between Form A Contacts: 250VDC (12V-24V coils), 210VDC (5V coils).
 Form C Contacts: 200VDC.
 Between Coil and Contacts: 1,500VDC.

Initial Insulation Resistance

Between Mutually Insulated Conductors: 10¹¹ ohms @ 500VDC.

Coil Data @ 25°C

Nominal Voltage: 5 to 24VDC.
 Nominal Power: 50 - 288mW.
 Maximum Coil Power:
 Temperature Rise:
 Duty Cycle:

Coil Data @ 20°C

| Nominal Voltage (VDC) | Resistance ± 10% (Ohms) | Operating Voltage (VDC) | |
|---|-------------------------|-------------------------|---------|
| | | (Min.) | (Max.) |
| DIP and SIP Version: SPST - 1 Form A | | | |
| 5 | 500 | 3.5 | 22 |
| 12 | 1,000 | 8.4 | 33 |
| 15 | 2,000 | 10.5 | 44 |
| 24 | 2,000 | 16.8 | 44 |
| DIP Version: DPST - 2 Form A | | | |
| 5 | 200 | 3.5 | 14 |
| 12 | 500 | 8.4 | 25 |
| 15 | 2,000 | 10.5 | 47 |
| 24 | 2,000 | 16.8 | 47 |
| DIP Version: SPDT - 1 Form C | | | |
| 5 | 200 | 3.5 | 13 (14) |
| 12 | 500 | 8.4 | 22 (23) |
| 15 | 2,000 | 10.5 | 44 (49) |
| 24 | 2,000 | 16.8 | 44 (49) |

*Values in brackets refer to high relay version with protective diode.

Operate Data @ 20°C

Must Operate Voltage: 70% of nominal voltage.
Must Release Voltage: 15% of nominal voltage.

| Type of Relay | DIP Version | | SIP Version |
|---------------------------------|----------------------------------|----------------|----------------|
| Type of Contacts | SPST, 1 Form A DPST, 2 Form A | SPDT, 1 Form C | SPST, 1 Form A |
| Operate Time (Including Bounce) | 0.5ms | 0.7ms | 0.5ms |
| Release Time (Including Bounce) | 0.2ms | 1.0ms | 0.2ms |

Operate Bounce:
Release Bounce:

Environmental Data

Temperature Range: -20°C to +70°C.
 Vibration, Operational:
 Shock, Operational:
 Shock, Non-destructive:

Mechanical Data

Termination:
 Enclosure:
 Weight:

Ordering Information

| | | | | |
|---|------------------|----------|-----------|----------|
| Typical Part Number ▶ | V23100-V4 | 3 | 24 | A |
| 1. Basic Series: V23100-V4 – DIL and SIP reed relay. | | | | |
| 2. Version: DIP flat package: 0 – 1 Form A contacts. 3 – 1 Form C standard and 1 Form C with electrostatical shield. DIP high package: 3 – 2 Form A contacts and 1 Form C with diode or electrostatical shield and diode. SIP package: 5 | | | | |
| 3. Coil Voltage: 05 – 5VDC 12 – 12VDC 15 – 15VDC 24 – 24VDC | | | | |
| 4. Contact Arrangement: A – 1 Form A (not for high DIP). B – 2 Form a (high DIP only). C – 1 Form C (not for SIP). | | | | |
| 5. Options: 000 – standard. 001 – with electrostatical shield 010 – with diode. 011 – with electrostatical shield and diode. | | | | |

Stock Items – The following items are normally maintained in stock for immediate delivery.

| | |
|-----------------|-----------------|
| V23100V4005A000 | V23100V4505A000 |
| V23100V4012A000 | V23100V4517A000 |
| V23100V4024A000 | V23100V4524A000 |

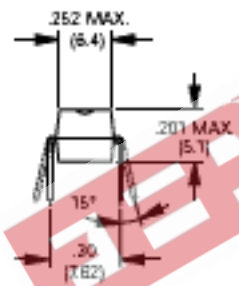
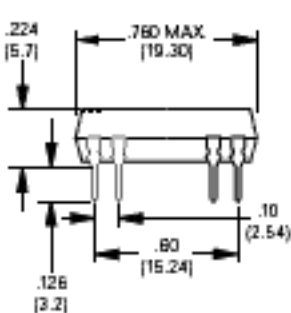
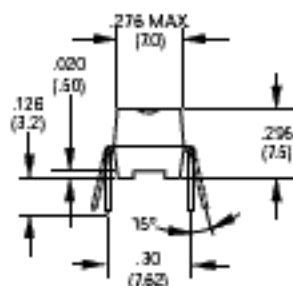
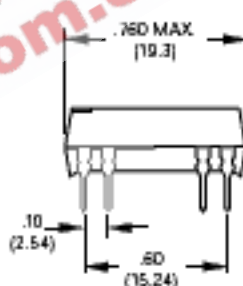
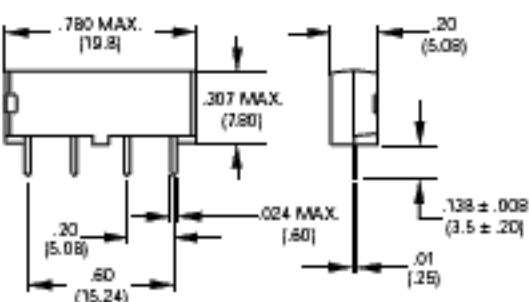
Outline Dimensions
DIP Version (Flat)

DIP Version (High)

SIP Version

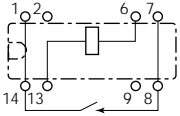
Wiring Diagrams (Bottom Views)
DIP Version (Flat)

SPST-1 Form A
standard

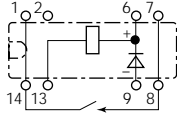

SPST-1 Form A
w/diode



SPDT-1 Form C
standard

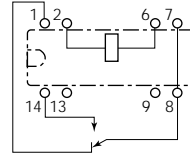

SPST-1 Form A
w/electrostatic Shield

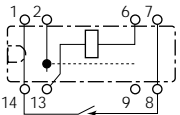

SPST-1 Form A
w/electrostatic shield and diode

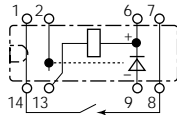

SPDT-1 Form C
w/electrostatic shield

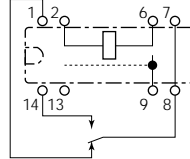

DIP Version (High)

DPST-2 Form A
standard

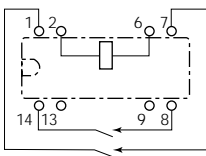

SPDT-1 Form C
w/diode

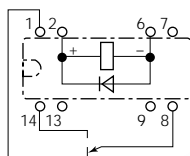

DPST-2 Form A
w/diode

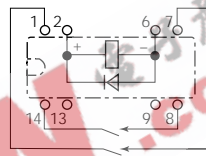

SPDT-1 Form C
w/electrostatic shield and diode

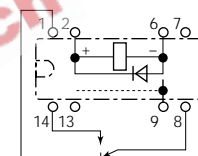

SIP Version

SPST-1 Form A
standard

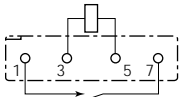

SPST-1 Form A
w/diode

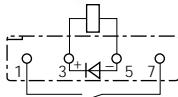

PC Board Layouts (Bottom Views)

DIP Version (Flat)

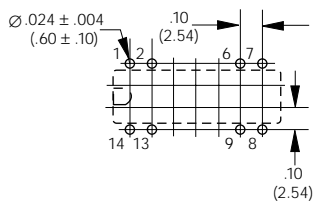

DIP Version (High)

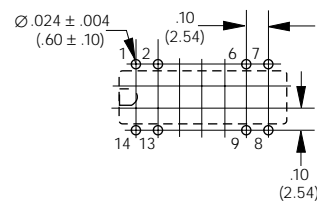

SIP Version

