

Varistor Products

Base Mount

PA Varistor Series



The PA Series of transient surge suppressors are metal-oxide varistors (MOVs) featuring a rigid base mount package construction, and are useful in applications which are subject to vibration.

These UL and CSA recognized varistors are available in a wide range of operating voltages, from 130V to 660V $V_{M(AC)RMS}$. The base-mount package has a quick-connect tab terminal that provides a fast, secure lead attach. The mounting base forms the second electrical connection, usually chassis ground. Meeting rigid NEMA standards, PA series varistors have a creep and strike distance capability that minimizes breakdown along the package surface.

See PA Series Device Ratings and Specifications table for part number and brand information.

Features

- Wide Operating Voltage Range
 $V_{M(AC)RMS}$ 130V to 660V
- Creep and Strike Distance Capability Meets Rigid NEMA Standards
- Base Mount Construction Forms One Electrical Connection
- Quick Connect Tab Terminal
- No Derating Up to 85°C Ambient

AGENCY APPROVALS: Recognized under the components program of Underwriters Laboratories. Certified by CSA.

AGENCY FILE NUMBERS: UL E75961, CSA LR91788.

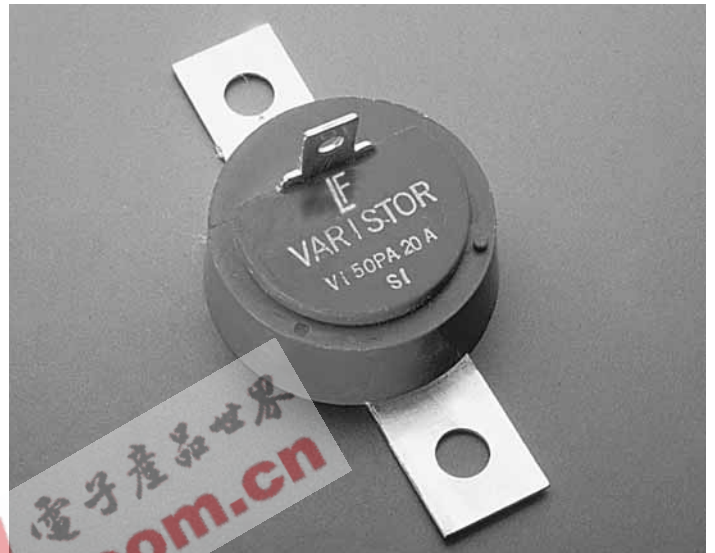

Varistor Products

Base Mount

PA Varistor Series

Absolute Maximum Ratings For ratings of individual members of a series, see Device Ratings and Specifications chart

	PA SERIES	UNITS
Continuous:		
Steady State Applied Voltage:		
AC Voltage Range ($V_{M(AC)RMS}$)	130 to 660	V
DC Voltage Range ($V_{M(DC)}$)	175 to 850	V
Transient:		
Peak Pulse Current (I_{TM})		
For 8/20 μ s Current Wave (See Figure 2)	6500	A
Single Pulse Energy Range		
For 10/1000 μ s Current Wave (W_{TM})	70 to 250	J
Operating Ambient Temperature Range (T_A)	-55 to 85	°C
Storage Temperature Range (T_{STG})	-55 to 125	°C
Temperature Coefficient (α_V) of Clamping Voltage (V_C) at Specified Test Current	<0.01	%/°C

CAUTION: Stresses above those listed in "Absolute Maximum Ratings" may cause permanent damage to the device. This is a stress only rating and operation of the device at these or any other conditions above those indicated in the operational sections of this specification is not implied.

Device Ratings and Specifications

PART NUMBER AND DEVICE BRANDING	MAXIMUM RATINGS (85°C)				SPECIFICATIONS (25°C)					
	CONTINUOUS		TRANSIENT		VARISTOR VOLTAGE AT 1mA DC TEST CURRENT			MAX CLAMPING VOLT V_C AT TEST CURRENT (8/20 μ s)		TYPICAL CAPACITANCE
	V_{RMS}	V_{DC}	ENERGY (10/1000 μ s)	PEAK CURRENT (8/20 μ s)						
	$V_{M(AC)}$	$V_{M(DC)}$	W_{TM}	I_{TM}	MIN	$V_N(DC)$	MAX	V_C	I_P	f = 1MHz
(V)	(V)	(J)	(A)	(V)	(V)	(V)	(V)	(A)	(pF)	
V130PA20A	130	175	70	6500	184	200	243	360	100	1900
V130PA20C	130	175	70	6500	184	200	220	325	100	1900
V150PA20A	150	200	80	6500	212	240	284	420	100	1600
V150PA20C	150	200	80	6500	212	240	243	360	100	1600
V250PA40A	250	330	130	6500	354	390	453	675	100	1000
V250PA40C	250	330	130	6500	354	390	413	620	100	1000
V275PA40A	275	369	140	6500	389	430	494	740	100	900
V275PA40C	275	369	140	6500	389	430	453	680	100	900
V320PA40A	320	420	160	6500	462	510	565	850	100	750
V320PA40C	320	420	160	6500	462	510	540	800	100	750
V350PA40A	350	460	165	6500	500	559	618	910	100	700
V350PA40C	350	460	165	6500	500	535	570	840	100	700
V420PA40A	420	560	170	6500	610	680	790	1160	100	600
V420PA40C	420	560	170	6500	610	680	690	1050	100	600
V480PA80A	480	640	180	6500	670	750	860	1280	100	550
V480PA80C	480	640	180	6500	670	750	790	1160	100	550
V510PA80A	510	675	190	6500	735	820	963	1410	100	500
V510PA80C	510	675	190	6500	735	820	860	1280	100	500
V575PA80A	575	730	220	6500	805	910	1050	1560	100	450
V575PA80C	575	730	220	6500	805	910	960	1410	100	450
V660PA100A	660	850	250	6500	940	1050	1210	1820	100	400

Varistor Products

Base Mount

PA Varistor Series

Power Dissipation Ratings

Should transients occur in rapid succession, the average power dissipation required is simply the energy (watt-seconds) per pulse times the number of pulses per second. The power so developed must be within the specifications shown on the Device Ratings and Specifications table for the specific device. Furthermore, the operating values need to be derated at high temperatures as shown in Figure 1. Because varistors can only dissipate a relatively small amount of average power they are, therefore, not suitable for repetitive applications that involve substantial amounts of average power dissipation.

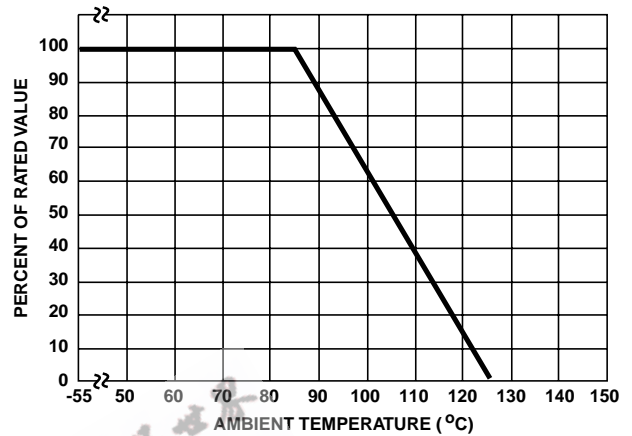
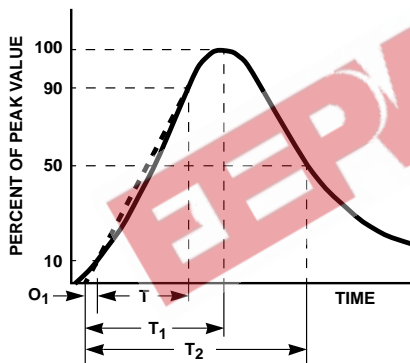

FIGURE 1. CURRENT, ENERGY AND POWER DERATING CURVE



O_1 = Virtual Origin of Wave
 T = Time From 10% to 90% of Peak
 T_1 = Virtual Front time = $1.25 \cdot t$
 T_2 = Virtual Time to Half Value (Impulse Duration)
 Example: For an $8/20\mu s$ Current Waveform:
 $8\mu s = T_1$ = Virtual Front Time
 $20\mu s = T_2$ = Virtual Time to Half Value

FIGURE 2. PEAK PULSE CURRENT TEST WAVEFORM

Transient V-I Characteristics Curves

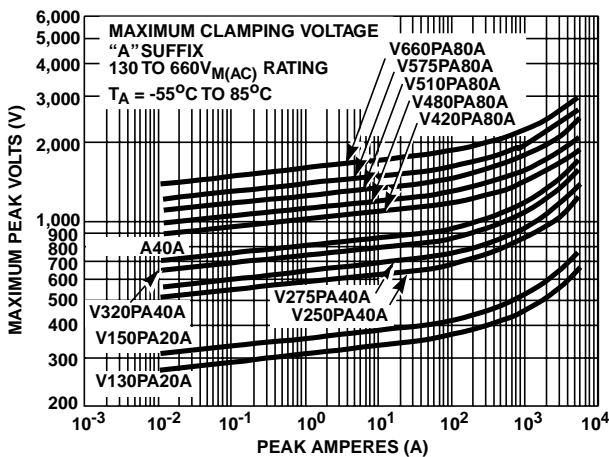

FIGURE 3. CLAMPING VOLTAGE FOR V130PA20A - V660PA100A

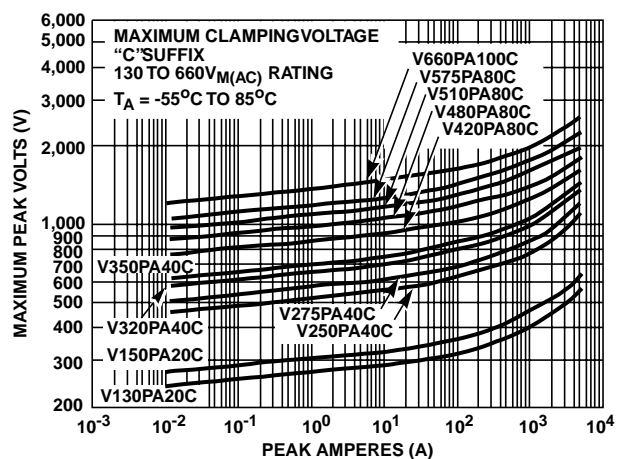

FIGURE 4. CLAMPING VOLTAGE FOR V130PA20C - V660PA100C

Varistor Products

Base Mount

PA Varistor Series

Pulse Rating Curves

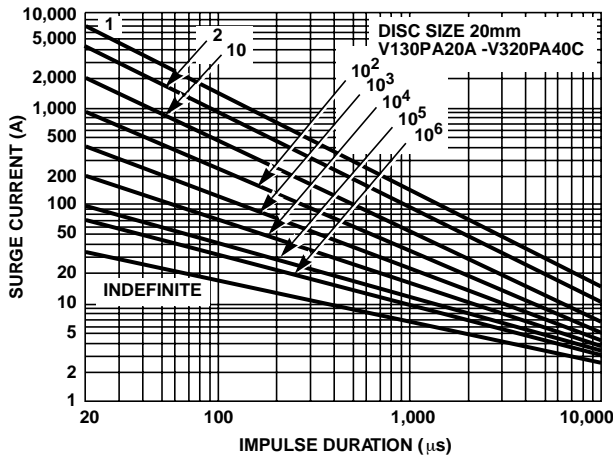

FIGURE 5. SURGE CURRENT RATING CURVES FOR V130PA20A - V320PA40C

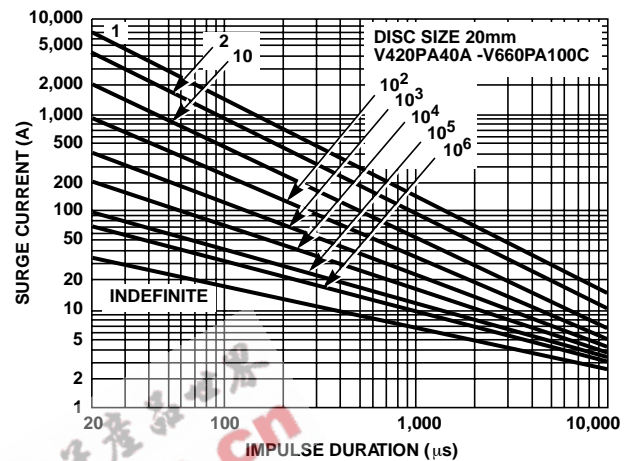
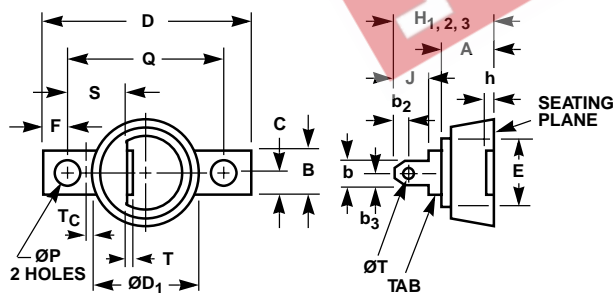

FIGURE 6. SURGE CURRENT RATING CURVES FOR V420PA40A - V660PA100C

NOTE: If pulse ratings are exceeded, a shift of $V_{N(DC)}$ (at specified current) of more than $\pm 10\%$ could result. This type of shift, which normally results in a decrease of $V_{N(DC)}$, may result in the device not meeting the original published specifications, but it does not prevent the device from continuing to function, and to provide transient protection

Mechanical Dimensions



NOTES:

1. Tab is designed to fit 1/4" quick-connect terminal.
2. Case temperature is measured at T_C on top surface of base plate.
3. H_1 (130-150 V_{RMS} devices).
 H_2 (250-320 V_{RMS} devices).
 H_3 (420-660 V_{RMS} devices).
4. Electrical connection: top terminal and base plate.
5. Typical weight: 30g.

SYM-BOL	MILLIMETERS			INCHES			NOTES
	MIN	NOM	MAX	MIN	NOM	MAX	
A	-	-	14.3	-	-	0.570	-
b	-	-	6.6	-	-	0.260	1
b2	3.94	4.06	4.18	0.155	0.160	0.165	-
b3	3.05	3.17	3.29	0.120	0.125	0.130	-
B	-	-	12.9	-	-	0.510	-
C	-	-	6.6	-	-	0.260	-
D	-	-	66.3	-	-	2.610	-
ØD1	-	-	33.5	-	-	1.320	-
E	-	11.2	-	-	0.440	-	-
F	7.50	7.62	7.75	0.295	0.300	0.305	-
h	-	0.8	1.0	-	0.030	0.040	-
H_1	-	-	25.6	-	-	1.010	3
H_2	-	-	28.3	-	-	1.120	3
H_3	-	-	32.8	-	-	1.290	3
J	-	-	8.1	-	-	0.320	-
ØP	5.6	-	6.0	0.220	-	0.240	-
Q	50.6	50.8	51.0	1.990	2.000	2.010	-
S	18.4	19.2	20.0	0.72	0.75	0.78	-
T	-	-	1.0	-	-	0.040	-
ØT	2.8	-	-	0.110	-	-	-
T_C	-	3.2	-	-	0.126	-	2

Varistor Products

Base Mount

PA Varistor Series

Suggested Hardware and Mounting Arrangements

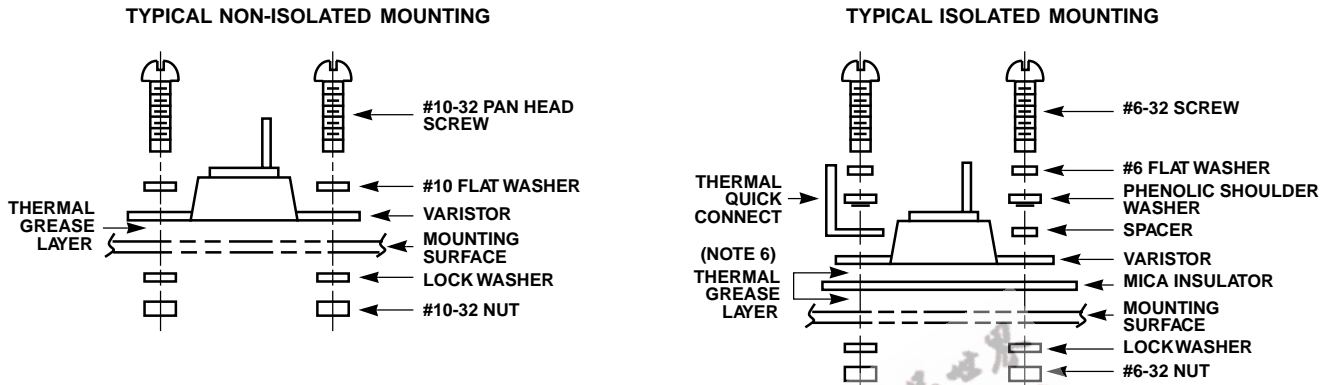

NOTE:

6. GE G623, Dow Corning, DC3, 4, 340, or 640 Thermal Grease recommended for best heat transfer.

1,000V Isolation Kit containing the following parts can be ordered by part #A7811055 (Qty).

- | | | | |
|--|------------------------------|-------------------------|-----------------------------------|
| (1) MICA insulation 1 1/8" x 3.1" / 0.005" thick | (2) Phenolic shoulder washer | (2) #6-32 / 3 / 4 screw | (2) #6 internal tooth lock washer |
| (1) 1/4 " quick-connect terminal | (1) Spacer | (2) #6-32 nut | (2) #6 flat washer |

Ordering Information

