



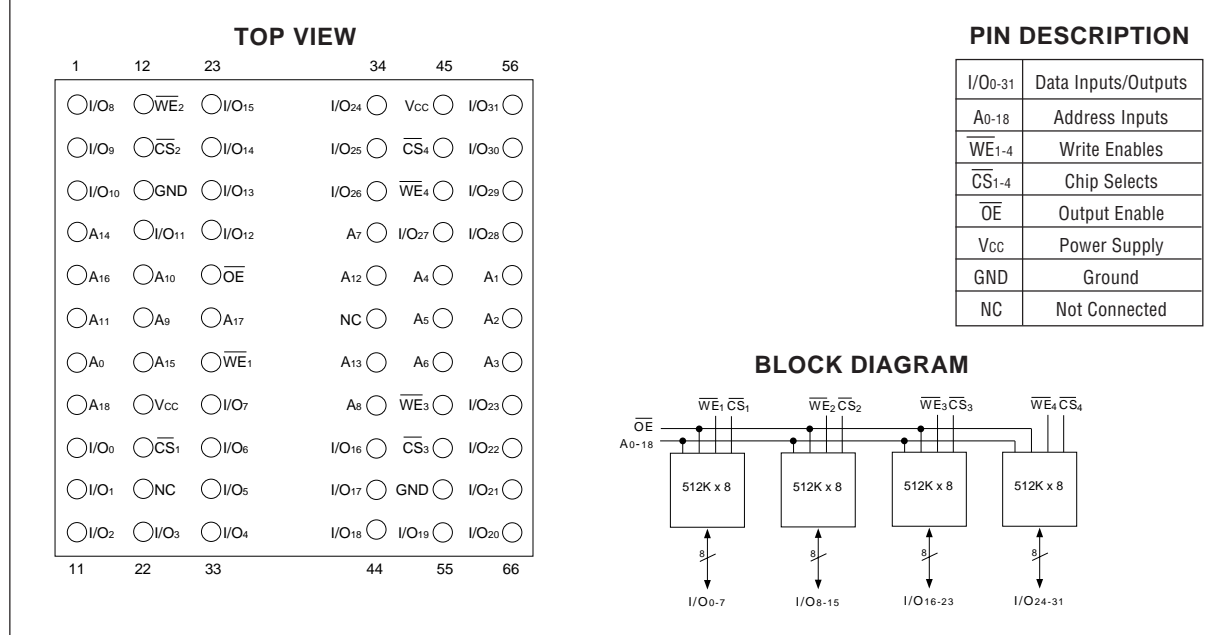
## 512Kx32 5V FLASH MODULE, SMD 5962-94612

### FEATURES

- Access Times of 60, 70, 90, 120, 150ns
- Packaging
  - 66 pin, PGA Type, 1.075" square, Hermetic Ceramic HIP (Package 400<sup>(1)</sup>)
  - 68 lead, 40mm, Low Capacitance Hermetic CQFP (Package 501)
  - 68 lead, 40mm, Low Profile 3.5mm (0.140"), CQFP (Package 502)
  - 68 lead, 22.4mm (0.880") Low Profile CQFP (G2U), 3.5mm (0.140") high, (Package 510)
  - 68 lead, 23.9mm (0.940") Low Profile CQFP (G1U), 3.5mm (0.140") high, (Package 519)
- 100,000 Erase/Program Cycles Minimum
- Sector Architecture
  - 8 equal size sectors of 64KBytes each
  - Any combination of sectors can be concurrently erased. Also supports full chip erase
- Organized as 512Kx32
- Commercial, Industrial and Military Temperature Ranges
- 5 Volt Programming. 5V ±10% Supply.
- Low Power CMOS, 6.5mA Standby
- Embedded Erase and Program Algorithms
- TTL Compatible Inputs and CMOS Outputs
- Built-in Decoupling Caps for Low Noise Operation
- Page Program Operation and Internal Program Control Time
- Weight
  - WF512K32-XG2UX5 - 8 grams typical
  - WF512K32-XH1X5 - 13 grams typical
  - WF512K32-XG4X5 - 20 grams typical
  - WF512K32-XG4TX5 - 20 grams typical
  - WF512K32-XG1UX5 - 5 grams typical

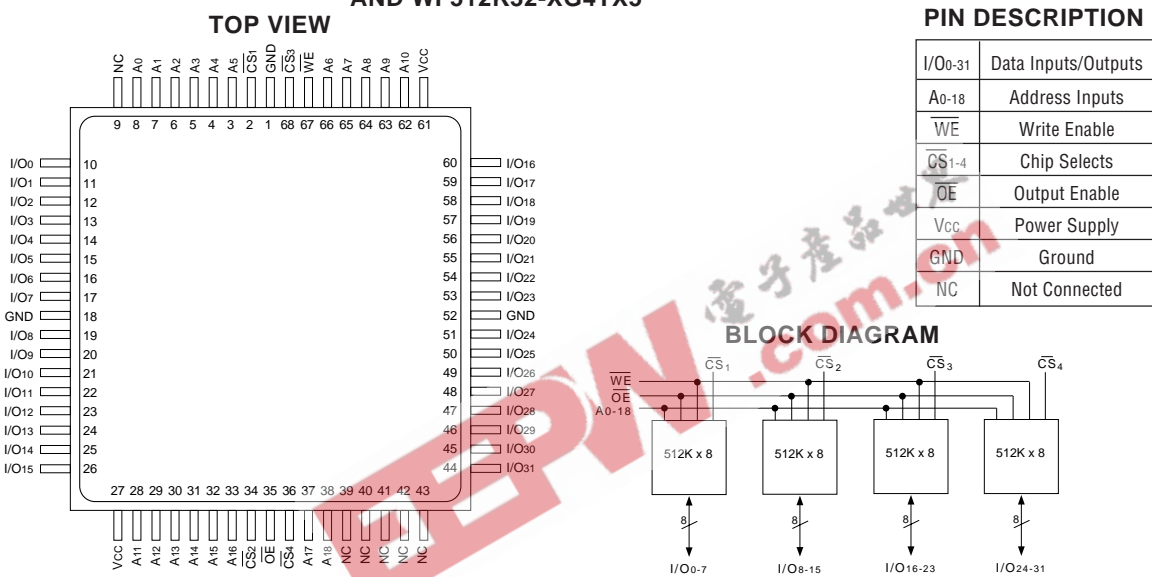
1. Call factory for PGA type (HIP) package options.  
Note: See Flash Programming Application Note 4M5 for algorithms.

**FIG. 1 PIN CONFIGURATION FOR WF512K32N-XH1X5**

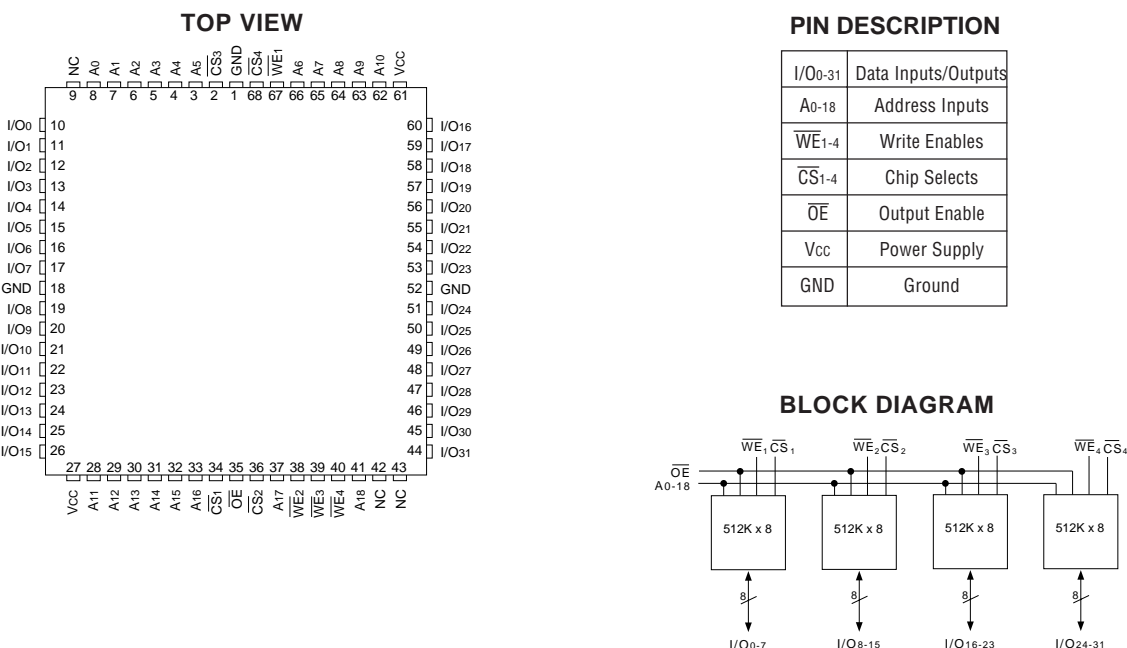




**FIG. 2 PIN CONFIGURATION FOR WF512K32F-XG4X5 (Low Capacitance) AND WF512K32-XG4TX5**



**FIG. 3 PIN CONFIGURATION FOR WF512K32-XG2UX5 AND WF512K32-XG1UX5**





**ABSOLUTE MAXIMUM RATINGS (1)**

Parameter		Unit
Operating Temperature	-55 to +125	°C
Supply Voltage Range (Vcc)	-2.0 to +7.0	V
Signal voltage range (any pin except A9) (2)	-2.0 to +7.0	V
Storage Temperature Range	-65 to +150	°C
Lead Temperature (soldering, 10 seconds)	+300	°C
Data Retention (Mil Temp)	20 years	
Endurance - write/erase cycles (Mil Temp)	100,000 cycles min.	
A9 Voltage for sector protect (VID) (3)	-2.0 to +14.0	V

**NOTES:**

1. Stresses above the absolute maximum rating may cause permanent damage to the device. Extended operation at the maximum levels may degrade performance and affect reliability.
2. Minimum DC voltage on input or I/O pins is -0.5V. During voltage transitions, inputs may overshoot Vss to -2.0 V for periods of up to 20ns. Maximum DC voltage on output and I/O pins is Vcc + 0.5V. During voltage transitions, outputs may overshoot to Vcc + 2.0 V for periods of up to 20ns.
3. Minimum DC input voltage on A9 pin is -0.5V. During voltage transitions, A9 may overshoot Vss to -2V for periods of up to 20ns. Maximum DC input voltage on A9 is +13.5V which may overshoot to 14.0 V for periods up to 20ns.

**RECOMMENDED OPERATING CONDITIONS**

Parameter	Symbol	Min	Max	Unit
Supply Voltage	Vcc	4.5	5.5	V
Input High Voltage	VIH	2.0	Vcc + 0.5	V
Input Low Voltage	VIL	-0.5	+0.8	V
Operating Temp. (Mil.)	TA	-55	+125	°C
Operating Temp. (Ind.)	TA	-40	+85	°C
A9 Voltage for Sector Protect	VID	11.5	12.5	V

**DC CHARACTERISTICS - CMOS COMPATIBLE**

(Vcc = 5.0V, Vss = 0V, TA = -55°C to +125°C)

Parameter	Symbol	Conditions	Min	Max	Unit
Input Leakage Current	ILI	Vcc = 5.5, VIN = GND or Vcc		10	µA
Output Leakage Current	ILOx32	Vcc = 5.5, VIN = GND or Vcc		10	µA
Vcc Active Current for Read (1)	Icc1	CS = VIL, OE = VIH, f = 5MHz		190	mA
Vcc Active Current for Program or Erase (2)	Icc2	CS = VIL, OE = VIH		240	mA
Vcc Standby Current	Icc4	Vcc = 5.5, CS = VIH, f = 5MHz		6.5	mA
Vcc Static Current	Icc3	Vcc = 5.5, CS = VIH		0.6	mA
Output Low Voltage	VOL	IOL = 8.0 mA, Vcc = 4.5		0.45	V
Output High Voltage	VOH1	Ioh = 2.5 mA, Vcc = 4.5	0.85 x Vcc		V
Low Vcc Lock-Out Voltage	VLKO		3.2	4.2	V

DC test conditions: VIL = 0.3V, VIH = Vcc - 0.3V

**NOTES:**

1. The Icc current listed includes both the DC operating current and the frequency dependent component (at 5 MHz). The frequency component typically is less than 2 mA/MHz, with OE at VIH.
2. Icc active while Embedded Algorithm (program or erase) is in progress.

**CAPACITANCE**

(TA = +25°C)

Parameter	Symbol	Conditions	Max	Unit
OE capacitance	COE	VIN = 0 V, f = 1.0 MHz	50	pF
WE1-4 capacitance HIP (PGA)	CWE	VIN = 0 V, f = 1.0 MHz	20	pF
CQFP G4T			50	
CQFP G2U/G1U			15	
CS1-4 capacitance	Ccs	VIN = 0 V, f = 1.0 MHz	20	pF
Data I/O capacitance	CI/O	VI/O = 0 V, f = 1.0 MHz	20	pF
Address input capacitance	CAD	VIN = 0 V, f = 1.0 MHz	50	pF

This parameter is guaranteed by design but not tested.

**LOW CAPACITANCE CQFP**

(TA = +25°C)

Parameter	Symbol	Conditions	Max	Unit
OE capacitance	COE	VIN = 0 V, f = 1.0 MHz	32	pF
CQFP G4 capacitance	CWE	VIN = 0 V, f = 1.0 MHz	32	pF
CS1-4 capacitance	Ccs	VIN = 0 V, f = 1.0 MHz	15	pF
Data I/O capacitance	CI/O	VI/O = 0 V, f = 1.0 MHz	15	pF
Address input capacitance	CAD	VIN = 0 V, f = 1.0 MHz	32	pF

This parameter is guaranteed by design but not tested.



AC CHARACTERISTICS – WRITE/ERASE/PROGRAM OPERATIONS,  $\overline{CS}$  CONTROLLED

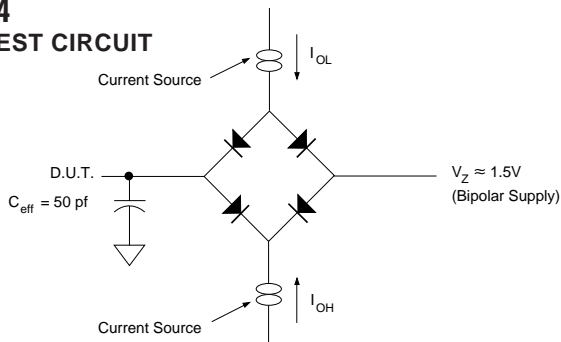
( $V_{CC} = 5.0V, V_{SS} = 0V, T_A = -55^\circ C$  to  $+125^\circ C$ )

Parameter	Symbol		-60		-70		-90		-120		-150		Unit
			Min	Max	Min	Max	Min	Max	Min	Max	Min	Max	
Write Cycle Time	$t_{AVAV}$	$t_{WC}$	60		70		90		120		150		ns
Write Enable Setup Time	$t_{WLEL}$	$t_{WS}$	0		0		0		0		0		ns
Chip Select Pulse Width	$t_{ELEH}$	$t_{CP}$	40		45		45		50		50		ns
Address Setup Time	$t_{AVEL}$	$t_{AS}$	0		0		0		0		0		ns
Data Setup Time	$t_{DVEH}$	$t_{DS}$	40		45		45		50		50		ns
Data Hold Time	$t_{EHDX}$	$t_{DH}$	0		0		0		0		0		ns
Address Hold Time	$t_{ELAX}$	$t_{AH}$	40		45		45		50		50		ns
Chip Select Pulse Width High	$t_{EHEL}$	$t_{CPH}$	20		20		20		20		20		ns
Duration of Byte Programming Operation (1)	$t_{WHWH1}$			300		300		300		300		300	$\mu s$
Sector Erase Time (2)	$t_{WHWH2}$			15		15		15		15		15	sec
Read Recovery Time	$t_{GHLE}$		0		0		0		0		0		ns
Chip Programming Time				11		11		11		11		11	sec
Chip Erase Time (3)				64		64		64		64		64	sec

NOTES:

1. Typical value for  $t_{WHWH1}$  is 7 $\mu s$ .
2. Typical value for  $t_{WHWH2}$  is 1sec.
3. Typical value for Chip Erase Time is 8sec.

FIG. 4  
AC TEST CIRCUIT



AC TEST CONDITIONS

Parameter	Typ	Unit
Input Pulse Levels	$V_{IL} = 0, V_{IH} = 3.0$	V
Input Rise and Fall	5	ns
Input and Output Reference Level	1.5	V
Output Timing Reference Level	1.5	V

NOTES:

$V_Z$  is programmable from -2V to +7V.  
 $I_{OL}$  &  $I_{OH}$  programmable from 0 to 16mA.  
 Tester Impedance  $Z_0 = 75 \Omega$ .  
 $V_Z$  is typically the midpoint of  $V_{OH}$  and  $V_{OL}$ .  
 $I_{OL}$  &  $I_{OH}$  are adjusted to simulate a typical resistive load circuit.  
 ATE tester includes jig capacitance.



**AC CHARACTERISTICS – WRITE/ERASE/PROGRAM OPERATIONS,  $\overline{WE}$  CONTROLLED**  
 (VCC = 5.0V, TA = -55°C to +125°C)

Parameter	Symbol		-60		-70		-90		-120		-150		Unit
			Min	Max	Min	Max	Min	Max	Min	Max	Min	Max	
Write Cycle Time	tAVAV	tWC	60		70		90		120		150		ns
Chip Select Setup Time	tELWL	tCS	0		0		0		0		0		ns
Write Enable Pulse Width	tWLWH	tWP	40		45		45		50		50		ns
Address Setup Time	tAVWH	tAS	0		0		0		0		0		ns
Data Setup Time	tDVWH	tDS	40		45		45		50		50		ns
Data Hold Time	tWHDX	tDH	0		0		0		0		0		ns
Address Hold Time	tWHAX	tAH	40		45		45		50		50		ns
Write Enable Pulse Width High	tWHWL	tWPH	20		20		20		20		20		ns
Duration of Byte Programming Operation (1)	tHWH1			300	300		300		300		300		μs
Sector Erase Time (2)	tHWH2			15	15		15		15		15		sec
Read Recovery Time before Write	tGHWL		0		0		0		0		0		ns
VCC Set-up Time		tVCS	50		50		50		50		50		μs
Chip Programming Time				11	11		11		11		11		sec
Output Enable Setup Time		tOES	0		0		0		0		0		ns
Output Enable Hold Time (4)		tOEH	10		10		10		10		10		ns
Chip Erase Time (3)				64	64		64		64		64		sec

**NOTES:**

1. Typical value for tHWH1 is 7μs.
2. Typical value for tHWH2 is 1sec.
3. Typical value for Chip Erase Time is 8sec.
4. For Toggle and Data Polling.

**AC CHARACTERISTICS – READ ONLY OPERATIONS**  
 (VCC = 5.0V, TA = -55°C to +125°C)

Parameter	Symbol		-60		-70		-90		-120		-150		Unit
			Min	Max	Min	Max	Min	Max	Min	Max	Min	Max	
Read Cycle Time	tAVAV	tRC	60		70		90		120		150		ns
Address Access Time	tAVQV	tACC		60		70		90		120		150	ns
Chip Select Access Time	tELQV	tCE		60		70		90		120		150	ns
Output Enable to Output Valid	tGLQV	tOE		30		35		35		50		55	ns
Chip Select to Output High Z (1)	tEHQZ	tDF		20		20		20		30		35	ns
Output Enable High to Output High Z (1)	tGHQZ	tDF		20		20		20		30		35	ns
Output Hold from Address, $\overline{CS}$ or $\overline{OE}$ Change, whichever is First	tAXQX	tOH	0		0		0		0		0		ns

1. Guaranteed by design, but not tested



**FIG. 5**  
AC WAVEFORMS FOR READ OPERATIONS

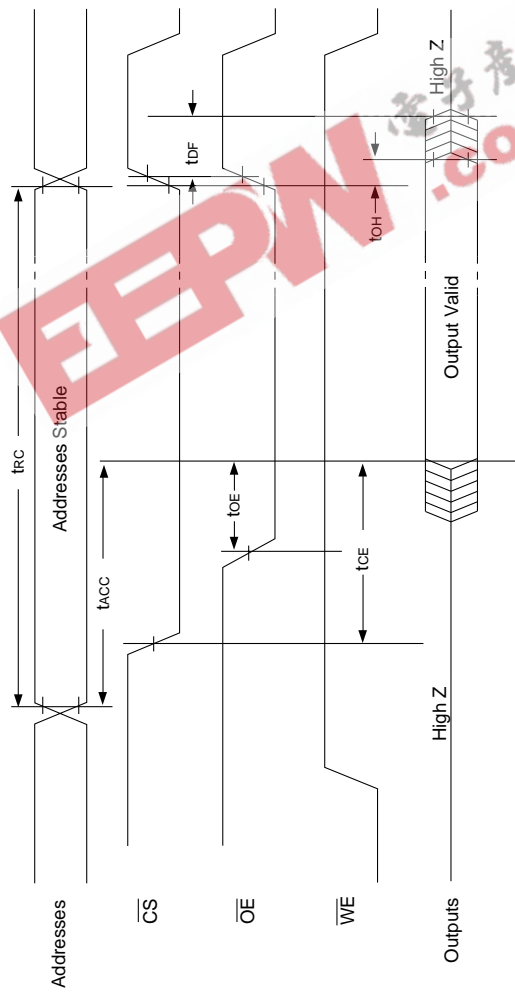
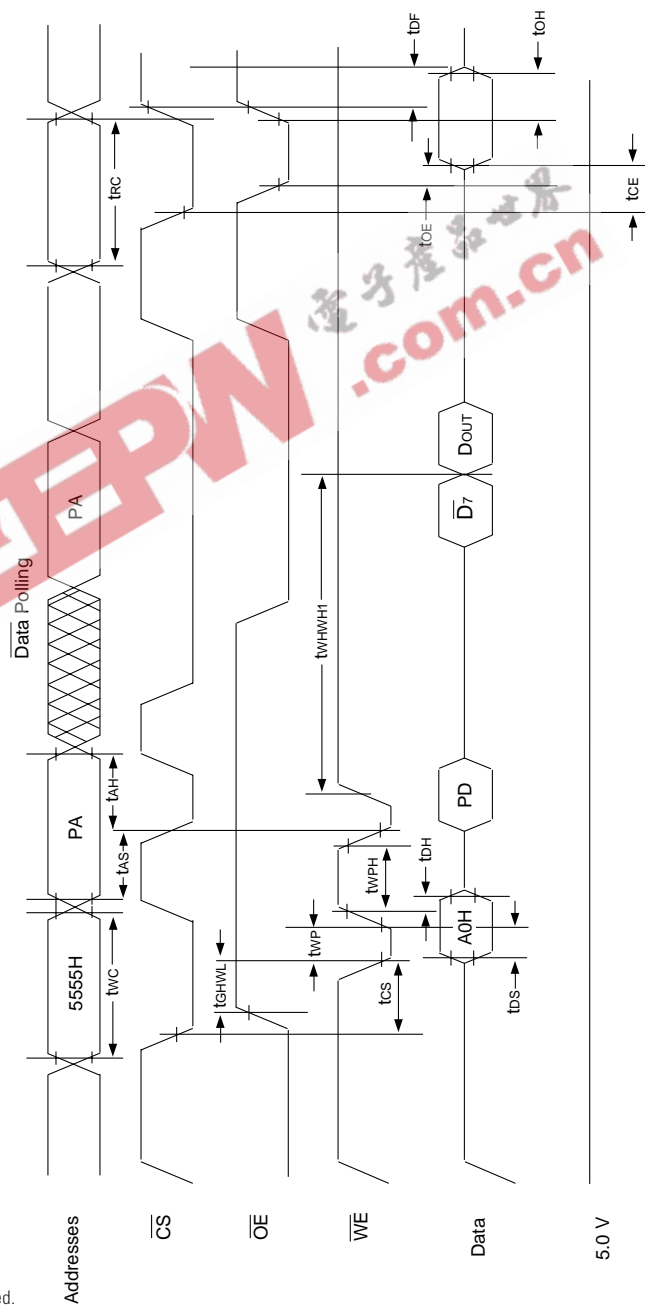




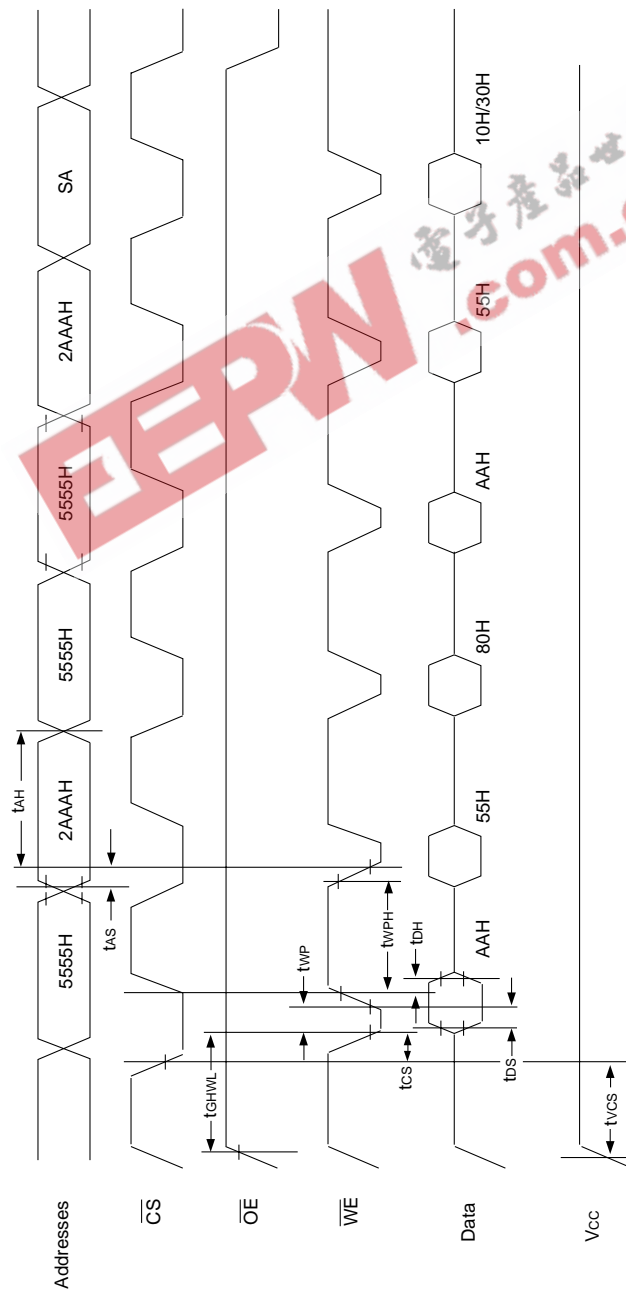
FIG. 6  
WRITE/ERASE/PROGRAM  
OPERATION, WE CONTROLLED



- NOTES:**
1. PA is the address of the memory location to be programmed.
  2. PD is the data to be programmed at byte address.
  3.  $\overline{D7}$  is the output of the complement of the data written to the device (for each chip).
  4. DOUT is the output of the data written to the device.
  5. Figure indicates last two bus cycles of four bus cycle sequence.



**FIG. 7**  
**AC WAVEFORMS CHIP/SECTOR**  
**ERASE OPERATIONS**

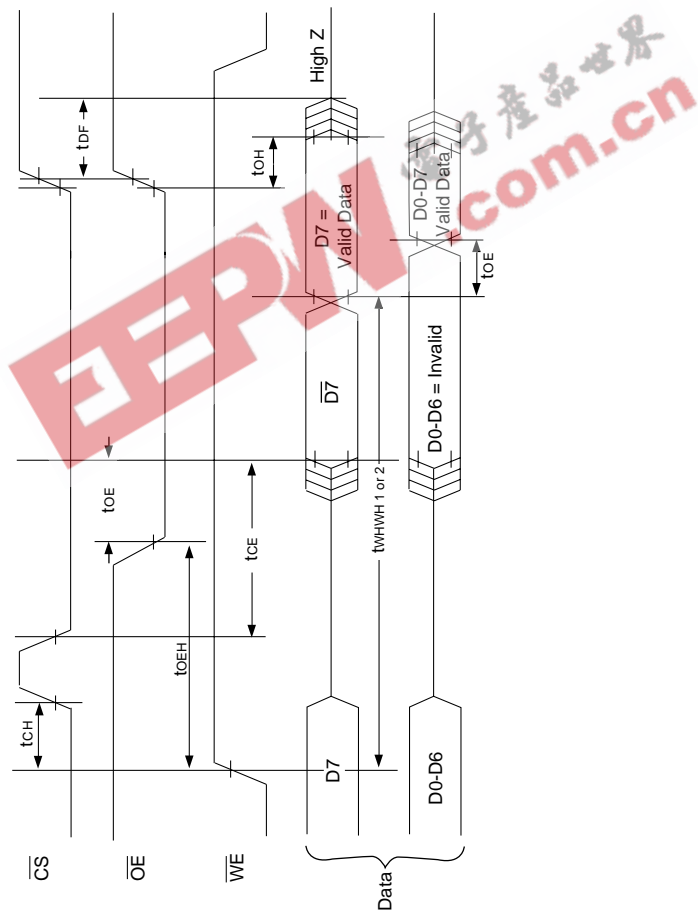


**NOTE:**  
1. SA is the sector address for Sector Erase.





**FIG. 8**  
AC WAVEFORMS FOR DATA POLLING  
DURING EMBEDDED ALGORITHM OPERATIONS





**FIG. 9**  
**ALTERNATE  $\overline{CS}$  CONTROLLED**  
**PROGRAMMING OPERATION TIMINGS**



**NOTES:**

1. PA represents the address of the memory location to be programmed.
2. PD represents the data to be programmed at byte address.
3. D7 is the output of the complement of the data written to the device (for each chip).
4. DOUT is the output of the data written to the device.
5. Figure indicates the last two bus cycles of a four bus cycle sequence.



**PACKAGE 400: 66 PIN, PGA TYPE, CERAMIC HEX-IN-LINE PACKAGE, HIP (H1)**



ALL LINEAR DIMENSIONS ARE MILLIMETERS AND PARENTHETICALLY IN INCHES



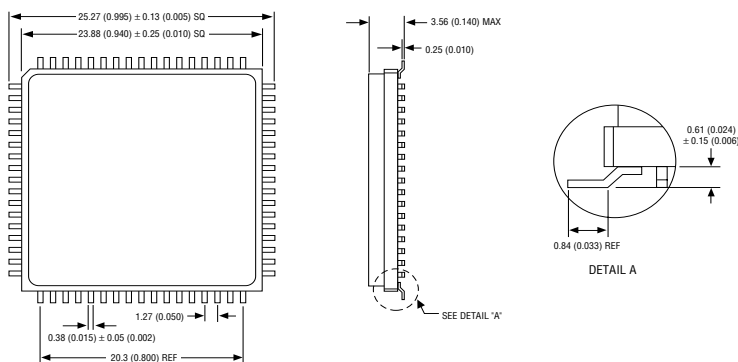
**PACKAGE 510: 68 LEAD, CERAMIC QUAD FLAT PACK, CQFP (G2U)**



The White 68 lead G2U CQFP fills the same fit and function as the JEDEC 68 lead CQFJ or 68 PLCC. But the G2U has the TCE and lead inspection advantage of the CQFP form.

ALL LINEAR DIMENSIONS ARE MILLIMETERS AND PARENTHEMICALLY IN INCHES

**PACKAGE 519: 68 LEAD, CERAMIC QUAD FLAT PACK, LOW PROFILE CQFP (G1U)**



ALL LINEAR DIMENSIONS ARE MILLIMETERS AND PARENTHEMICALLY IN INCHES





ORDERING INFORMATION

W F 512K32 X - XXX X X 5 X

LEAD FINISH:

- Blank = Gold plated leads
- A = Solder dip leads

V<sub>PP</sub> PROGRAMMING VOLTAGE

5 = 5 V

DEVICE GRADE:

- M = Military Screened -55°C to +125°C
- I = Industrial -40°C to +85°C
- C = Commercial 0°C to +70°C

PACKAGE TYPE:

- H1 = 1.075" sq. Ceramic Hex In Line Package, HIP (Package 400\*)
- G2U = 22.4mm Low Profile CQFP (Package 510)
- G1U = 23.9mm Low Profile CQFP (Package 519)
- G4 = 40mm Low Capacitance, CQFP (Package 501)
- G4T = 40mm Low Profile CQFP (Package 502)

ACCESS TIME (ns)

IMPROVEMENT MARK

- N = No Connect at pins 21 and 39 in HIP for Upgrade (H1 only)\*
- F = Low Capacitance Device (G4 only)

ORGANIZATION, 512K x 32

User configurable as 1M x 16 or 2M x 8

Flash

WHITE ELECTRONIC DESIGNS CORP.

\* Call factory for PGA type (HIP) package options.





DEVICE TYPE	SPEED	PACKAGE	SMD NO.
512K x 32 Flash Module	150ns	66 pin HIP (H1) 1.075" sq.	5962-94612 01HUX
512K x 32 Flash Module	120ns	66 pin HIP (H1) 1.075" sq.	5962-94612 02HUX
512K x 32 Flash Module	90ns	66 pin HIP (H1) 1.075" sq.	5962-94612 03HUX
512K x 32 Flash Module	70ns	66 pin HIP (H1) 1.075" sq.	5962-94612 04HUX
512K x 32 Flash Module	150ns	68 lead CQFP Low Profile (G4T)	5962-94612 01HTX
512K x 32 Flash Module	120ns	68 lead CQFP Low Profile (G4T)	5962-94612 02HTX
512K x 32 Flash Module	90ns	68 lead CQFP Low Profile (G4T)	5962-94612 03HTX
512K x 32 Flash Module	70ns	68 lead CQFP Low Profile (G4T)	5962-94612 04HTX
512K x 32 Flash Module	150ns	68 lead Low Capacitance CQFP (G4)	5962-94612 01HNX
512K x 32 Flash Module	120ns	68 lead Low Capacitance CQFP (G4)	5962-94612 02HNX
512K x 32 Flash Module	90ns	68 lead Low Capacitance CQFP (G4)	5962-94612 03HNX
512K x 32 Flash Module	70ns	68 lead Low Capacitance CQFP (G4)	5962-94612 04HNX
512K x 32 Flash Module	150ns	68 lead CQFP/J (G2U)	5962-94612 01HZX
512K x 32 Flash Module	120ns	68 lead CQFP/J (G2U)	5962-94612 02HZX
512K x 32 Flash Module	90ns	68 lead CQFP/J (G2U)	5962-94612 03HZX
512K x 32 Flash Module	70ns	68 lead CQFP/J (G2U)	5962-94612 04HZX
512K x 32 Flash Module	150ns	68 lead CQFP/J (G1U)	5962-94612 01H9X
512K x 32 Flash Module	120ns	68 lead CQFP/J (G2U)	5962-94612 02H9X
512K x 32 Flash Module	90ns	68 lead CQFP/J (G2U)	5962-94612 03H9X
512K x 32 Flash Module	70ns	68 lead CQFP/J (G2U)	5962-94612 04H9X