

# W91460N SERIES



## 3-MEMORY TONE/PULSE DIALER WITH SAVE FUNCTION

### GENERAL DESCRIPTION

The W91460N series are Si-gate CMOS ICs that provide the necessary signals for either tone or pulse dialing. The W91460N series features save memory and 3 by 16-digit automatic dialing memory.

### FEATURES

- DTMF/pulse switchable dialer
- Two by 32-digit redial and save memory
- Three by 16-digit one-touch direct memory
- Redial memory cascadable with normal dialing; dialing length is unlimited, but if length exceeds 32-digit the redial function is inhibited
- Pulse-to-tone (\*T) keypad for long distance call operation
- Uses 5 × 5 keyboard
- Easy operation with redial, flash, pause and \*T keypads
- Flash, pause, P→T (pulse-to-tone) can be stored as a digit in memory
- Dialing rate (10, 20 ppS ) selected by bonding option
- On-hook debounce time: 150 msec.
- Minimum tone output duration: 93 msec.
- Minimum intertone pause: 93 msec.
- Flash break time (73, 100, 300, 600 msec.) selectable by keypad; pause time is 1.0 sec.
- On-chip power-on reset
- Uses 3.579545 MHz crystal or ceramic resonator
- Packaged in 18-pin plastic DIP
- The different dialers in the W91460N series are shown in the following table:

| TYPE NO. | REPLACEMENT<br>TYPE NO. | PULSE<br>(ppS) | FLASH<br>(mS)  | PAUSE<br>(S) | M/B |
|----------|-------------------------|----------------|----------------|--------------|-----|
| W91462N  | W91462                  | 10             | 600/300/73/100 | 3.6          | Pin |
|          | W91463                  |                |                |              |     |
|          | W91464                  |                |                |              |     |
|          | W91465                  |                |                |              |     |
| W91466N  | W91466                  | 20             | 600/300/73/100 | 3.6          | Pin |
|          | W91467                  |                |                |              |     |

# W91460N SERIES



## PIN CONFIGURATION

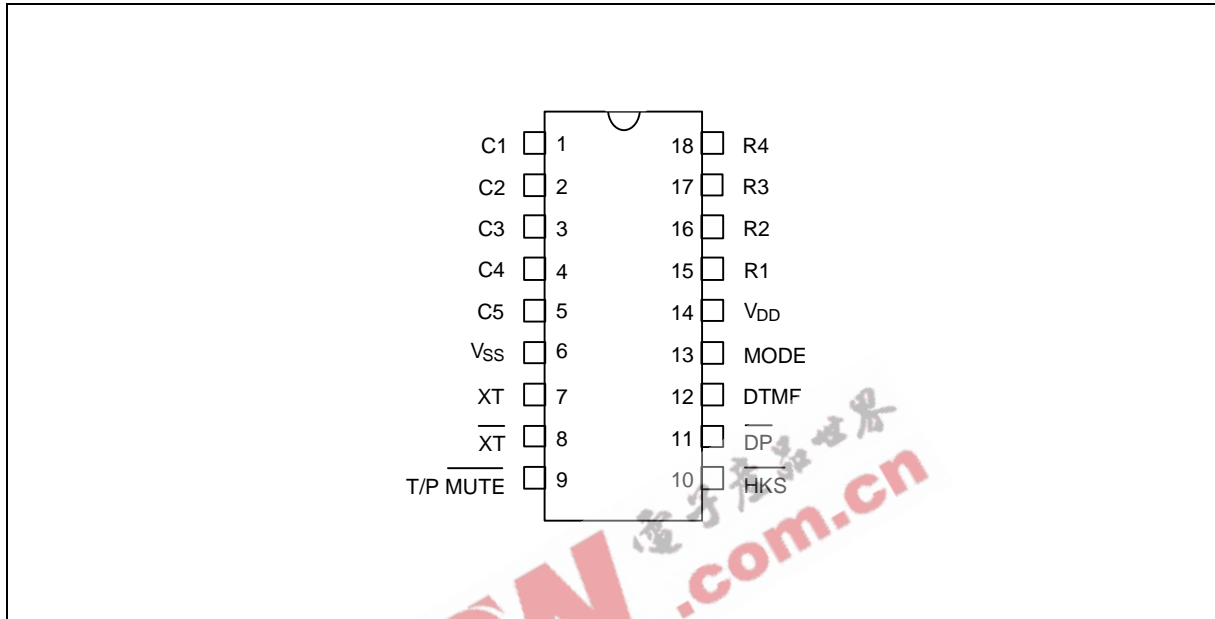

## PIN DESCRIPTION

| SYMBOL                       | PIN         | I/O  | FUNCTION  |
|------------------------------|-------------|------|---|
| Column-Row Inputs            | 1-5 & 15-18 | I    | The keyboard inputs may be used with either a standard 5 × 5 keyboard or an inexpensive single contact (Form A) keyboard. Electronic input from a $\mu$ C can also be used.<br>A valid key-in is defined as a single row being connected to a single column.  |
| XT, $\overline{\text{XT}}$   | 7, 8        | I, O | A built-in inverter provides oscillation with an inexpensive 3.579545 MHz crystal or ceramic resonator.   |
| $\overline{\text{T/P MUTE}}$ | 9           | O    | The $\overline{\text{T/P MUTE}}$ is a conventional CMOS N-channel open drain output. The output transistor is switched on during dialing sequence and flash break time. Otherwise, it is switched off.  |
| MODE                         | 13          | I    | Pulling mode pin to Vss places the dialer in tone mode.<br>Pulling mode pin to VDD places the dialer in pulse mode with M/B ratio 40:60 (10 ppS for W91462N and 20 ppS for W91466N).<br>Floating mode pin places the dialer in pulse mode with M/B ratio 33.3:66.7 (10 ppS for W91462N and 20 ppS for W91466N). |

# W91460N SERIES



Pin Description, continued

| SYMBOL                  | PIN       | I/O    | FUNCTION  |                  |  |  |  |  |           |        |         |    |     |     |       |    |     |     |       |    |     |     |       |    |     |     |       |    |      |      |       |    |      |      |       |    |      |      |       |
|-------------------------|-----------|--------|---|------------------|--|--|--|--|-----------|--------|---------|----|-----|-----|-------|----|-----|-----|-------|----|-----|-----|-------|----|-----|-----|-------|----|------|------|-------|----|------|------|-------|----|------|------|-------|
| $\overline{\text{HKS}}$ | 10        | I      | <p>Hook switch input.</p> <p><math>\overline{\text{HKS}} = \text{VDD}</math>: On-hook state. Chip in sleeping mode, no operation.</p> <p><math>\overline{\text{HKS}} = \text{VSS}</math>: Off-hook state. Chip is enabled for normal operation.</p> <p><math>\overline{\text{HKS}}</math> pin is pulled to VDD by an internal resistor.</p>   |                  |  |  |  |  |           |        |         |    |     |     |       |    |     |     |       |    |     |     |       |    |     |     |       |    |      |      |       |    |      |      |       |    |      |      |       |
| $\overline{\text{DP}}$  | 11        | O      | <p>N-channel open drain dialing pulse output.</p> <p>Flash key will cause <math>\overline{\text{DP}}</math> to be active in either tone mode or pulse mode.</p> <p>The timing diagram for pulse mode is shown in Figure 1(a, b, c).</p>   |                  |  |  |  |  |           |        |         |    |     |     |       |    |     |     |       |    |     |     |       |    |     |     |       |    |      |      |       |    |      |      |       |    |      |      |       |
| VDD, VSS                | 14, 6     | I      | Power input pins.   |                  |  |  |  |  |           |        |         |    |     |     |       |    |     |     |       |    |     |     |       |    |     |     |       |    |      |      |       |    |      |      |       |    |      |      |       |
| DTMF                    | 12        | O      | <p>In pulse mode, this pin remains in low state at all times.</p> <p>In tone mode, it will output a dual or single tone.</p> <p>Detailed timing diagram for tone mode is shown in Figure 2(a, b, c).</p> <table border="1" style="margin-left: auto; margin-right: auto;"> <thead> <tr> <th colspan="4">Output Frequency</th> </tr> <tr> <th></th> <th>Specified</th> <th>Actual</th> <th>Error %</th> </tr> </thead> <tbody> <tr> <td>R1</td> <td>697</td> <td>699</td> <td>+0.28</td> </tr> <tr> <td>R2</td> <td>770</td> <td>766</td> <td>-0.52</td> </tr> <tr> <td>R3</td> <td>852</td> <td>848</td> <td>-0.47</td> </tr> <tr> <td>R4</td> <td>941</td> <td>948</td> <td>+0.74</td> </tr> <tr> <td>C1</td> <td>1209</td> <td>1216</td> <td>+0.57</td> </tr> <tr> <td>C2</td> <td>1336</td> <td>1332</td> <td>-0.30</td> </tr> <tr> <td>C3</td> <td>1477</td> <td>1472</td> <td>-0.34</td> </tr> </tbody> </table> | Output Frequency |  |  |  |  | Specified | Actual | Error % | R1 | 697 | 699 | +0.28 | R2 | 770 | 766 | -0.52 | R3 | 852 | 848 | -0.47 | R4 | 941 | 948 | +0.74 | C1 | 1209 | 1216 | +0.57 | C2 | 1336 | 1332 | -0.30 | C3 | 1477 | 1472 | -0.34 |
| Output Frequency        |           |        |   |                  |  |  |  |  |           |        |         |    |     |     |       |    |     |     |       |    |     |     |       |    |     |     |       |    |      |      |       |    |      |      |       |    |      |      |       |
|                         | Specified | Actual | Error %   |                  |  |  |  |  |           |        |         |    |     |     |       |    |     |     |       |    |     |     |       |    |     |     |       |    |      |      |       |    |      |      |       |    |      |      |       |
| R1                      | 697       | 699    | +0.28   |                  |  |  |  |  |           |        |         |    |     |     |       |    |     |     |       |    |     |     |       |    |     |     |       |    |      |      |       |    |      |      |       |    |      |      |       |
| R2                      | 770       | 766    | -0.52   |                  |  |  |  |  |           |        |         |    |     |     |       |    |     |     |       |    |     |     |       |    |     |     |       |    |      |      |       |    |      |      |       |    |      |      |       |
| R3                      | 852       | 848    | -0.47   |                  |  |  |  |  |           |        |         |    |     |     |       |    |     |     |       |    |     |     |       |    |     |     |       |    |      |      |       |    |      |      |       |    |      |      |       |
| R4                      | 941       | 948    | +0.74   |                  |  |  |  |  |           |        |         |    |     |     |       |    |     |     |       |    |     |     |       |    |     |     |       |    |      |      |       |    |      |      |       |    |      |      |       |
| C1                      | 1209      | 1216   | +0.57   |                  |  |  |  |  |           |        |         |    |     |     |       |    |     |     |       |    |     |     |       |    |     |     |       |    |      |      |       |    |      |      |       |    |      |      |       |
| C2                      | 1336      | 1332   | -0.30   |                  |  |  |  |  |           |        |         |    |     |     |       |    |     |     |       |    |     |     |       |    |     |     |       |    |      |      |       |    |      |      |       |    |      |      |       |
| C3                      | 1477      | 1472   | -0.34   |                  |  |  |  |  |           |        |         |    |     |     |       |    |     |     |       |    |     |     |       |    |     |     |       |    |      |      |       |    |      |      |       |    |      |      |       |

# W91460N SERIES



## BLOCK DIAGRAM

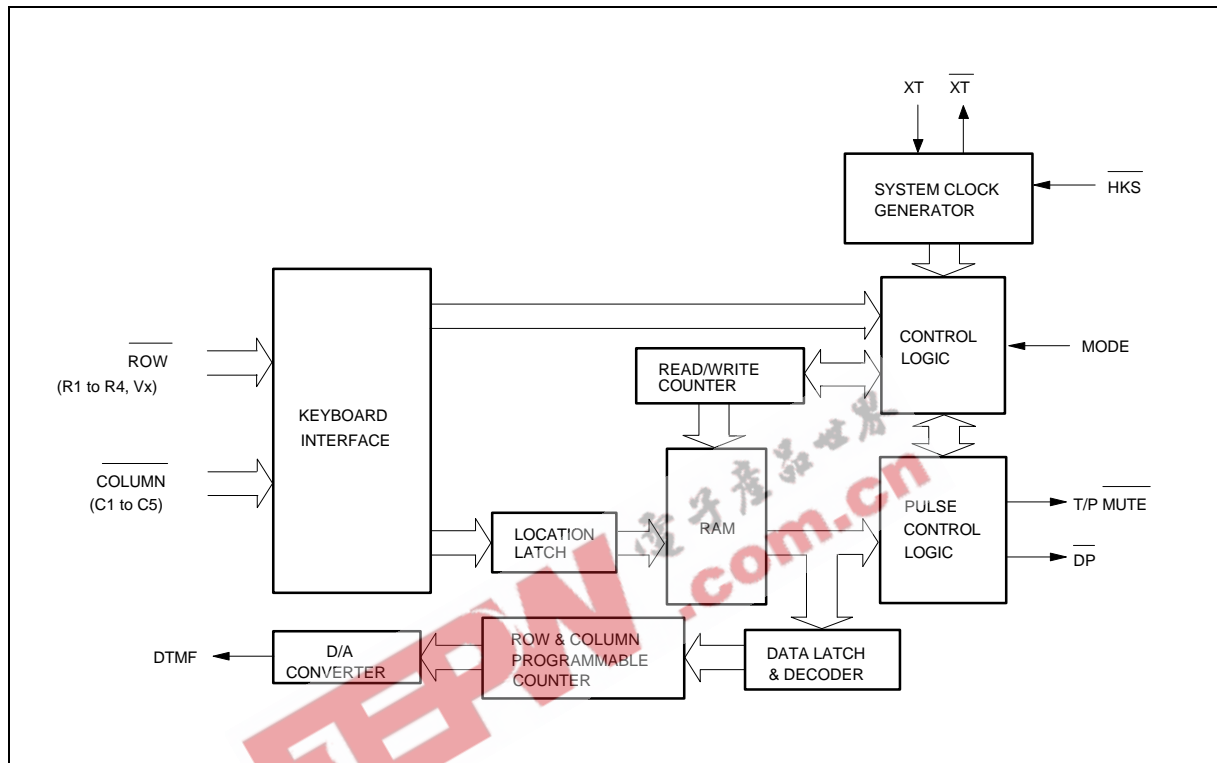

## FUNCTIONAL DESCRIPTION

### Keyboard Operation

| C1  | C2 | C3 | C4  | C5   |    |
|-----|----|----|-----|------|----|
| 1   | 2  | 3  | S   | M1   | R1 |
| 4   | 5  | 6  | F4  | M2   | R2 |
| 7   | 8  | 9  |     | M3   | R3 |
| */T | 0  | #  | R/P | SAVE | R4 |
| F1  | F2 | F3 |     |      | VX |

- S: Store function key
- R/P: Redial and pause function key
- SAVE: Save function key
- \*/T: \* in tone mode and P→T in pulse mode
- M1, ..., M3: One-touch memory
- F1, ..., F4: Flash keys, F1 = 600 mS, F2 = 300 mS, F3 = 73 mS, F4 = 100 mS

Note: D1, ..., Dn, D1', ..., Dn': 0, ..., 9, \*/T, #; Mn: M1, ..., M3; Fn: F1, ..., F4

# W91460N SERIES



## Normal Dialing

OFF HOOK , D1 , D2 , ..., Dn

1. D1, D2, ..., Dn will be dialed out.
2. Dialing length is unlimited, but redial is inhibited if length exceeds 32 digits in normal dialing.

## Redialing

OFF HOOK , D1 , D2 , ..., Dn Busy, Come ON HOOK , OFF HOOK , R/P

1. The redial memory content will be dialed out.
2. The R/P key can execute the redial function only as the first key-in after off-hook; otherwise, it executes the pause function.
3. If redialing length exceeds 32 digits, the redialing function will be inhibited.

## Number Store

OFF HOOK , D1 , D2 , ..., Dn , S , S , Mn

1. If the sequence of the dialed digits D1, D2, ..., Dn has not finished, S will be ignored.
2. D1, D2, ..., Dn will be dialed out and stored in memory location.

OFF HOOK , S , D1 , D2 , ..., Dn , S , Mn

3. D1, D2, ..., Dn will be stored in memory location but will not be dialed out.
4. R/P and \*/T keys can be stored as a digit in memory. In store R/P is the pause mode,

function key; \*/T is the pulse to tone function key.

The store mode is released after the store function is executed or when the state of the hook switch is changed.

## Repertory Dialing

OFF HOOK , Mn

## Access Pause

OFF HOOK , D1 , D2 , R/P , D3 , ..., Dn

1. The pause function can be stored as a digit in memory.
2. The pause function is executed in normal dialing, redial dialing, or memory dialing.
3. A detailed timing diagram for the pause function is shown in Figure 3.

## Pulse-to-tone (\*T)

# W91460N SERIES



OFF HOOK , D1 , D2 , ..., Dn , \*/T , D1' , D2' , ..., Dn'

1. If the mode switch is set to pulse mode, then the output signal will be:  
D1, D2, ..., Dn, Pause (3.6 sec.), D1', D2', ..., Dn'  
(Pulse) (Tone)
2. If the mode switch is set to tone mode, then the output signal will be as follows:  
D1, D2, ..., Dn, \*, D1', D2', ..., Dn'  
(Tone) (Tone)
3. The dialer remains in tone mode when the digits have been dialed out and can be reset to pulse mode only by going on-hook.
4. The pulse-to-tone function timing diagram is shown in Figure 4.

## Flash

OFF HOOK , Fn

1. Fn = F1, ..., F4
2. The dialer will execute a flash break time of 600 mS (F1), 300 mS (F2), 73 mS (F3), or 100 mS (F4) In each case, the flash pause time is 1.0 sec. before the next digit is dialed out.
3. Flash key can be stored as a digit in memory; however, only one flash will be released to users.
4. The system will return to the initial state after the flash pause time is finished.
5. The timing diagram of flash function is shown in Figure 5.

## Save

OFF HOOK , D1 , D2 , ..., Dn , SAVE

1. If the dialing D1 to Dn is finished, pressing the SAVE key will cause D1 to Dn to be copied to the save memory.

OFF HOOK , SAV  
E

2. D1 to Dn will be dialed out after the save key is pressed.

## Cascaded Dialing

1. Normal Dialing + Repertory Dialing + Normal Dialing
2. Repertory Dialing + Normal Dialing + Repertory Dialing
3. Redialing + Normal + Repertory Dialing

# W91460N SERIES



|  |         |  |
|--|---------|--|
|  | Dialing |  |
|--|---------|--|

Redialing is valid as first key-in only.

**EEPW** 电子產品世界  
.com.cn

# W91460N SERIES



## ABSOLUTE MAXIMUM RATINGS

| PARAMETER             | SYMBOL                           | RATING               | UNIT |
|-----------------------|----------------------------------|----------------------|------|
| DC Supply Voltage     | V <sub>DD</sub> -V <sub>SS</sub> | -0.3 to +7.0         | V    |
| Input/Output Voltage  | V <sub>IL</sub>                  | V <sub>SS</sub> -0.3 | V    |
|                       | V <sub>IH</sub>                  | V <sub>DD</sub> +0.3 | V    |
|                       | V <sub>OL</sub>                  | V <sub>SS</sub> -0.3 | V    |
|                       | V <sub>OH</sub>                  | V <sub>DD</sub> +0.3 | V    |
| Power Dissipation     | P <sub>D</sub>                   | 120                  | mW   |
| Operation Temperature | T <sub>OPR</sub>                 | -20 to +70           | °C   |
| Storage Temperature   | T <sub>STG</sub>                 | -55 to +150          | °C   |

Note: Exposure to conditions beyond those listed under Absolute Maximum Ratings may adversely affect the life and reliability of the device.

## DC CHARACTERISTICS

(V<sub>DD</sub>-V<sub>SS</sub> = 2.5V, F<sub>osc.</sub> = 3.579545 MHz, T<sub>A</sub> = 25° C, All outputs unloaded)

| PARAMETER  | SYMBOL           | CONDITIONS  | MIN. | TYP. | MAX. | UNIT  |
|--|------------------|---|------|------|------|-------|
|  |                  |   |      |      |      |       |
| Operating Voltage                                | V <sub>DD</sub>  | -   | 2.0  | -    | 5.5  | V     |
| Operating Current                                | I <sub>OP</sub>  | Tone, Unloaded  | -    | 0.4  | 0.6  | mA    |
|  |                  | Pulse, Unloaded   | -    | 0.2  | 0.4  |       |
| Standby Current                                  | I <sub>SB</sub>  | $\overline{\text{HKS}} = \text{V}_{\text{SS}}$ , No load & No key entry | -    | -    | 15   | μA    |
| Memory Retention Current                         | I <sub>MR</sub>  | $\overline{\text{HKS}} = \text{V}_{\text{DD}}$ , V <sub>DD</sub> = 1.0V | -    | -    | 0.2  | μA    |
| DTMF Output Voltage                              | V <sub>T0</sub>  | Row group, R <sub>L</sub> = 5 KΩ  | 130  | 150  | 170  | mVrms |
| Pre-emphasis                                     |                  | Col/Row, V <sub>DD</sub> = 2.0 to 5.5V                                  | 1    | 2    | 3    | dB    |
| DTMF Distortion                                  | THD              | R <sub>L</sub> = 5 KΩ, V <sub>DD</sub> = 2.0 to 5.5V                    | -    | -30  | -23  | dB    |
| DTMF Output DC Level                             | V <sub>TDC</sub> | R <sub>L</sub> = 5 KΩ, V <sub>DD</sub> = 2.0 to 5.5V                    | 1.0  | -    | 3.0  | V     |
| DTMF Output Sink Current                         | I <sub>TL</sub>  | V <sub>T0</sub> = 0.5V  | 0.2  | -    | -    | mA    |
| $\overline{\text{DP}}$ Output Sink Current       | I <sub>PL</sub>  | V <sub>PO</sub> = 0.5V  | 0.5  | -    | -    | mA    |
| T/P $\overline{\text{MUTE}}$ Output Sink Current | I <sub>ML</sub>  | V <sub>TMO</sub> = 0.5V   | 0.5  | -    | -    | mA    |



# W91460N SERIES



DC Characteristics, continued

| PARAMETER                  | SYMBOL          | CONDITIONS            | MIN. | TYP. | MAX. | UNIT |
|----------------------------|-----------------|-----------------------|------|------|------|------|
| Keypad Input Drive Current | I <sub>KD</sub> | V <sub>I</sub> = 0.0V | 30   | -    | -    | μA   |
| Keypad Input Sink Current  | I <sub>KS</sub> | V <sub>I</sub> = 2.5V | 200  | 400  | -    | μA   |
| HKS I/P Pull-high Resistor | R <sub>HK</sub> | -                     | -    | 300  | -    | KΩ   |
| Keypad Resistance          | R <sub>K</sub>  | -                     | -    | -    | 5.0  | KΩ   |

## AC CHARACTERISTICS

(V<sub>DD</sub>-V<sub>SS</sub> = 2.5V, F<sub>osc.</sub> = 3.579545 MHz, T<sub>A</sub> = 25° C, All outputs unloaded)

| PARAMETER                          | SYMBOL            | CONDITIONS             | MIN. | TYP.      | MAX. | UNIT |
|------------------------------------|-------------------|------------------------|------|-----------|------|------|
| Key-in Debounce                    | T <sub>KID</sub>  | -                      | -    | 20        | -    | mS   |
| Key Release Debounce               | T <sub>KRD</sub>  | -                      | -    | 20        | -    | mS   |
| Pre-digit Pause <sup>1</sup>       | T <sub>PDP1</sub> | Mode = V <sub>DD</sub> | -    | 40        | -    | mS   |
|                                    |                   | Mode = Floating        | -    | 33.3      | -    |      |
| Pre-digit Pause <sup>2</sup>       | T <sub>PDP2</sub> | Mode = V <sub>DD</sub> | -    | 20        | -    | mS   |
|                                    |                   | Mode = Floating        | -    | 16.7      | -    |      |
| Interdigit Pause<br>(Auto Dialing) | T <sub>IDP</sub>  | 10 ppS                 | -    | 800       | -    | mS   |
|                                    |                   | 20 ppS                 | -    | 500       | -    |      |
| Make/Break Ratio                   | M:B               | Mode = V <sub>DD</sub> | -    | 40:60     | -    | %    |
|                                    |                   | Mode = Floating        | -    | 33.3:66.7 | -    |      |
| Tone Output Duration               | T <sub>TD</sub>   | Auto dialing           | -    | 93        | -    | mS   |
| Intertone Pause                    | T <sub>ITP</sub>  | Auto dialing           | -    | 93        | -    | mS   |
| Flash Break Time                   | T <sub>FB</sub>   | F1                     | -    | 600       | -    | mS   |
|                                    |                   | F2                     | -    | 300       | -    |      |
|                                    |                   | F3                     | -    | 73        | -    |      |
|                                    |                   | F4                     | -    | 100       | -    |      |
| Flash Pause Time                   | T <sub>FP</sub>   | F1, F2, F3, F4         | -    | 1.0       | -    | S    |
| Pause Time                         | T <sub>P</sub>    | -                      | -    | 3.6       | -    | S    |
| On-hook Debounce Time              | T <sub>OHD</sub>  | -                      | -    | 150       | -    | mS   |

Notes:

- Crystal parameters suggested for proper operation are R<sub>s</sub> < 100 Ω, L<sub>m</sub> = 96 mH, C<sub>m</sub> = 0.02 pF, C<sub>n</sub> = 5 pF, C<sub>l</sub> = 18 pF, F<sub>osc.</sub> = 3.579545 MHz ±0.02%.
- Crystal oscillator accuracy directly affects these times.

Publication Release Date: May 1997

Revision A2

# W91460N SERIES



## TIMING WAVEFORMS

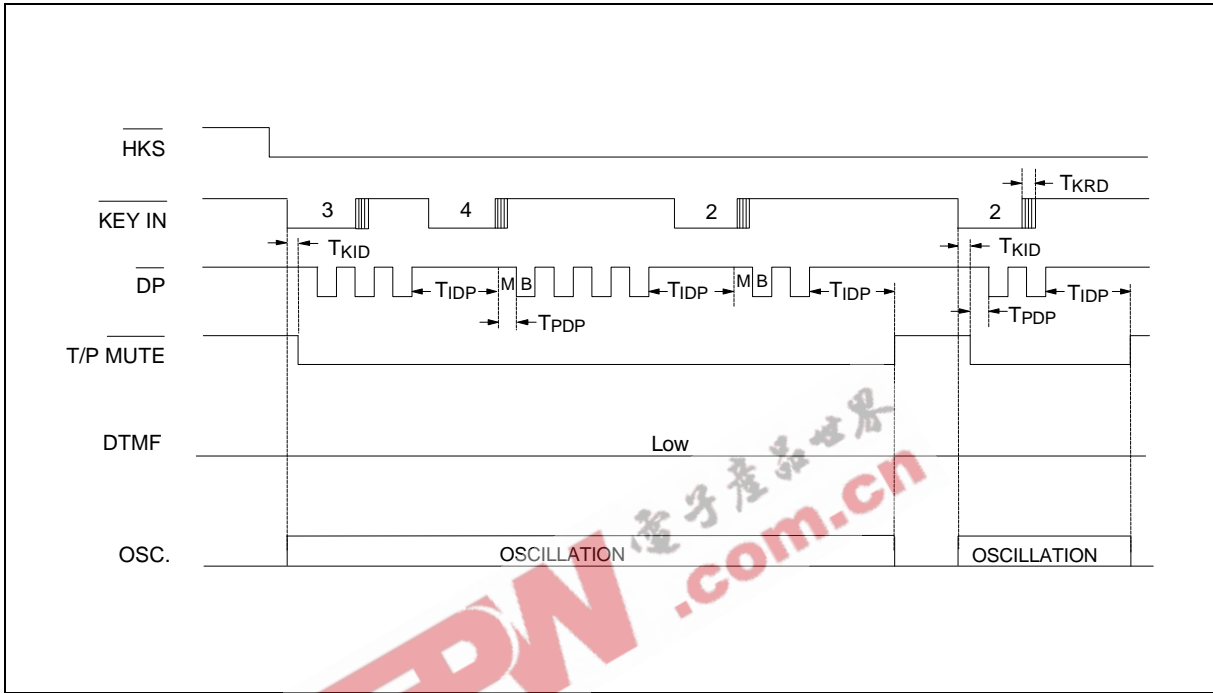

Figure 1(a) Normal Dialing Timing Diagram

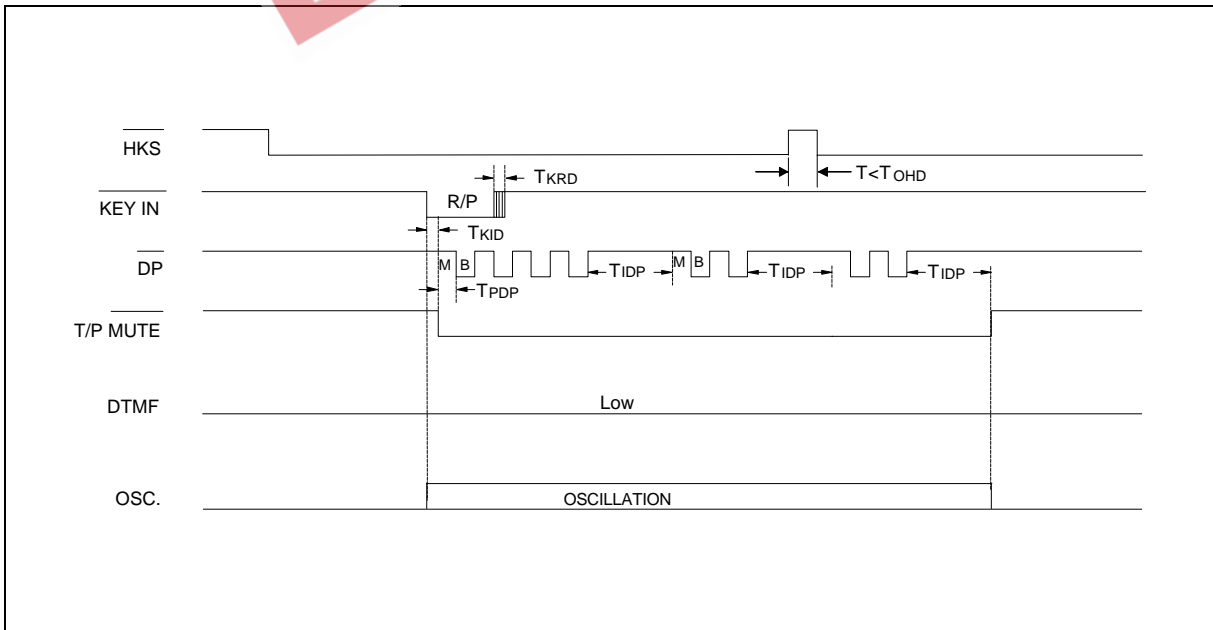

Figure 1(b) Pulse Mode Auto Dialing Timing Diagram

# W91460N SERIES



Timing Waveforms, continued

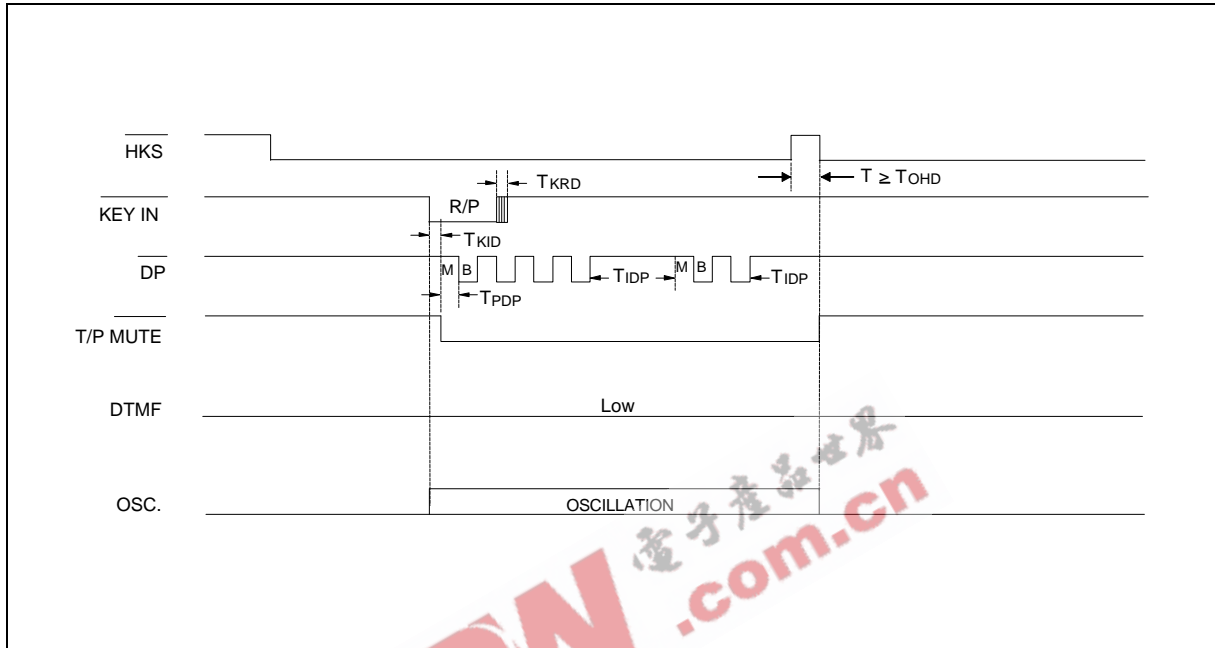

Figure 1(c) Pulse Mode Auto Dialing Timing Diagram

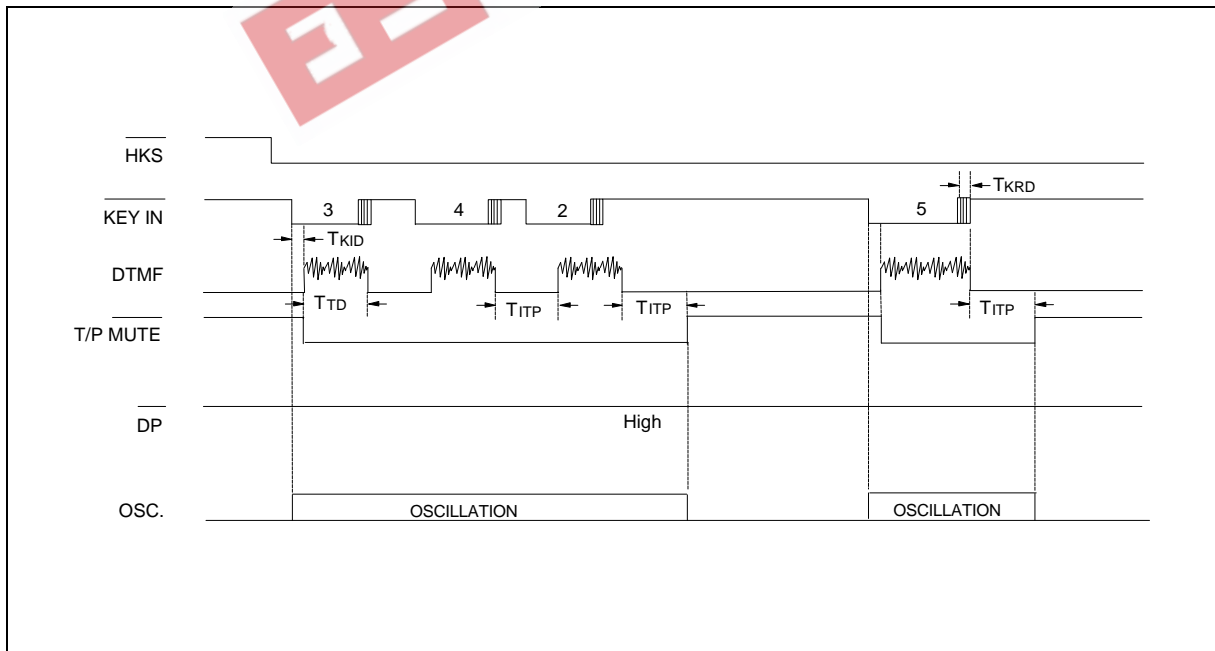

Figure 2(a) Tone Mode Normal Dialing Timing Diagram

# W91460N SERIES



Timing Waveforms, continued

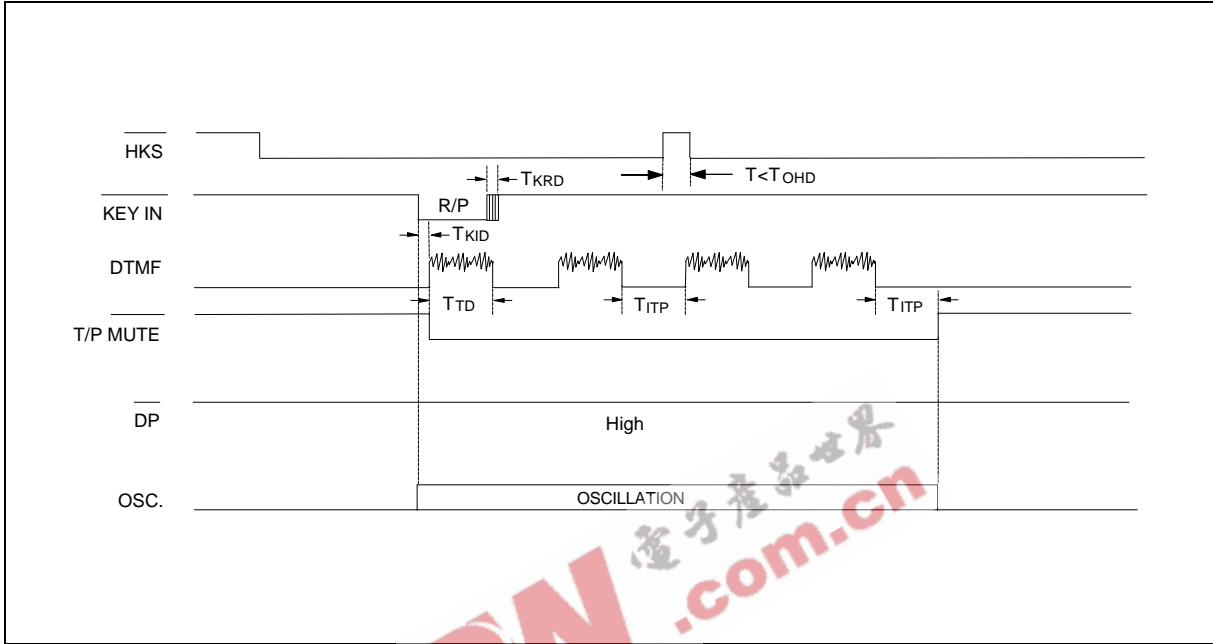

Figure 2(b) Tone Mode Auto Dialing Timing Diagram

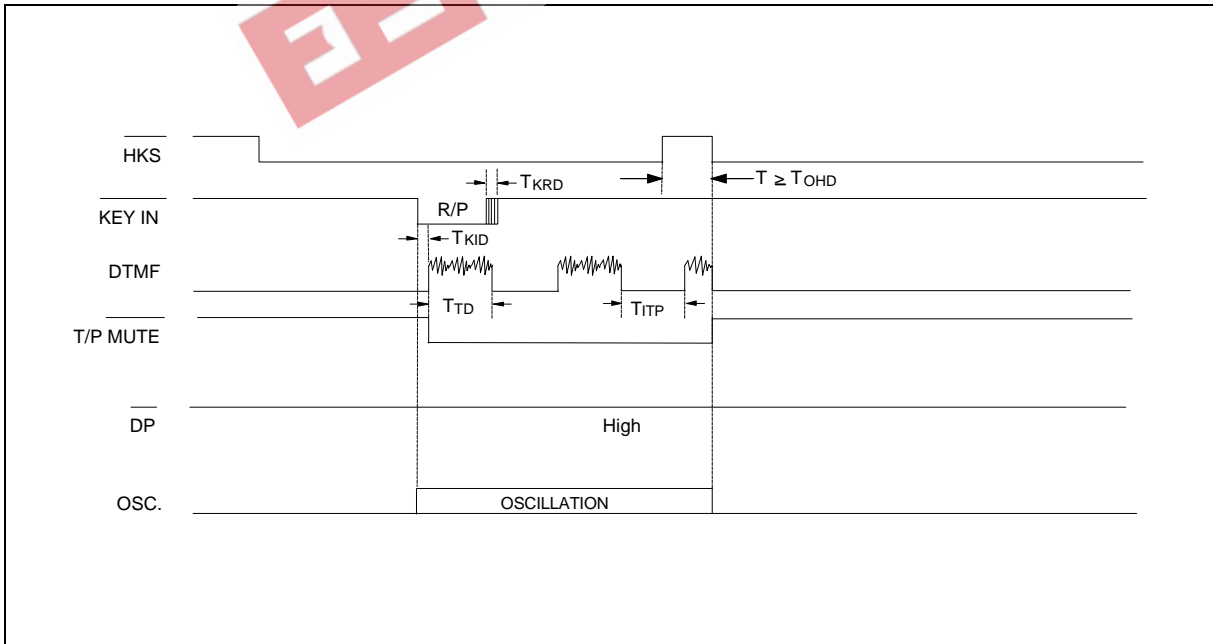

Figure 2(c) Tone Mode Auto Dialing Timing Diagram

# W91460N SERIES



Timing Waveforms, continued

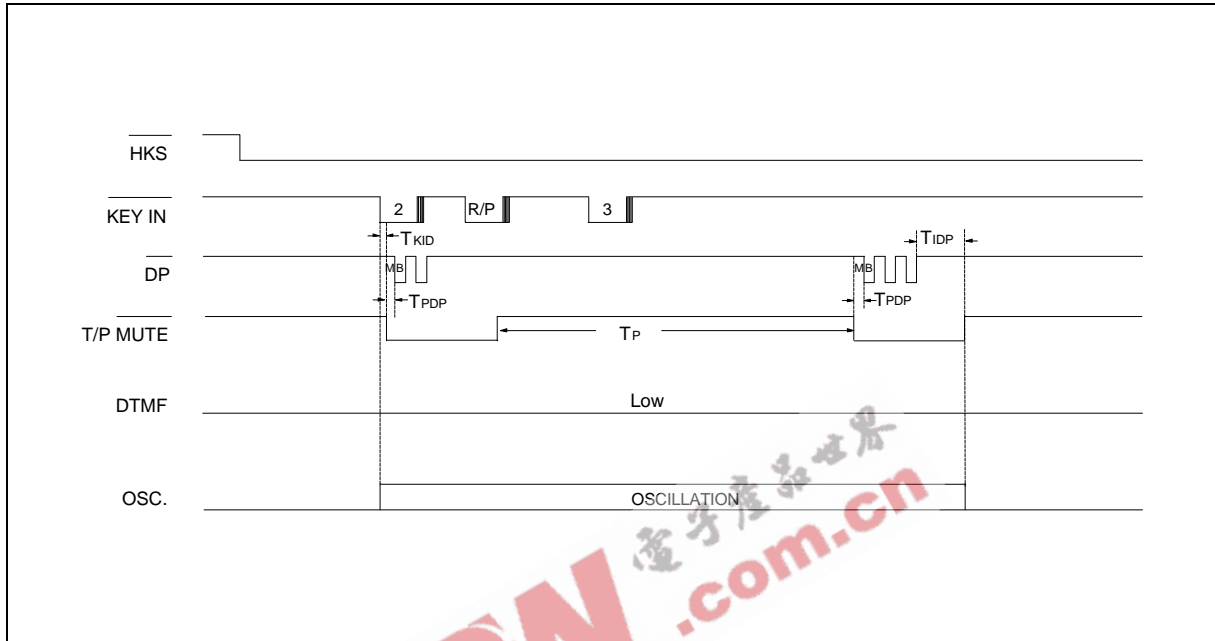

Figure 3. Pause Function Timing Diagram

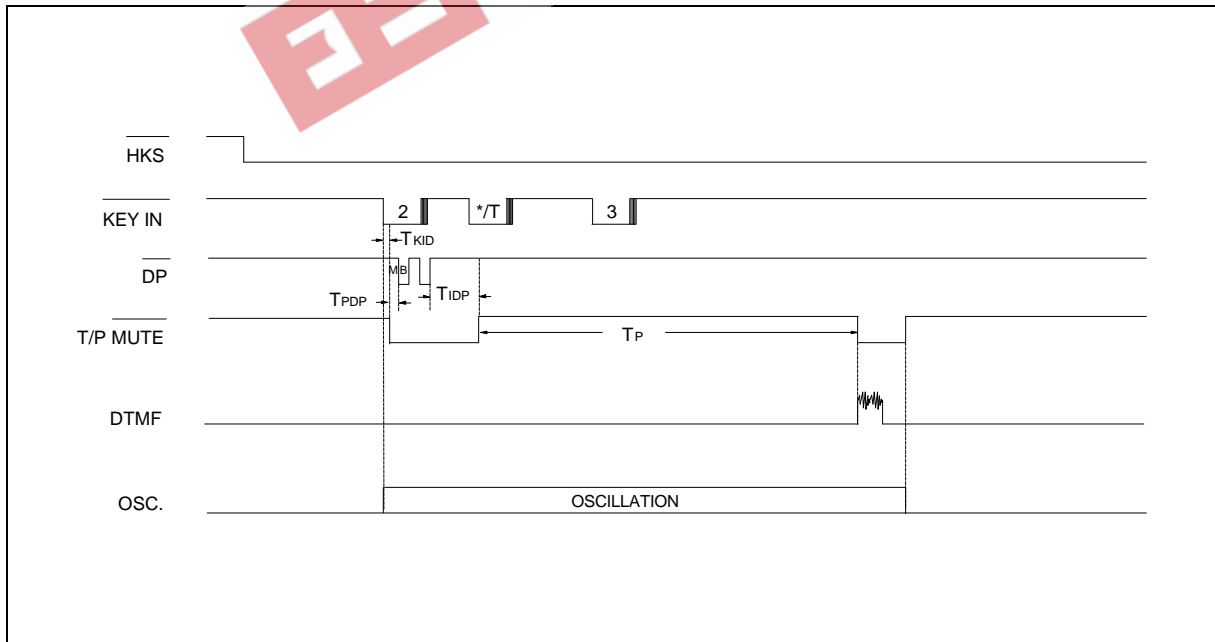

Figure 4. Pulse-to-tone Timing Diagram

# W91460N SERIES



Timing Waveforms, continued

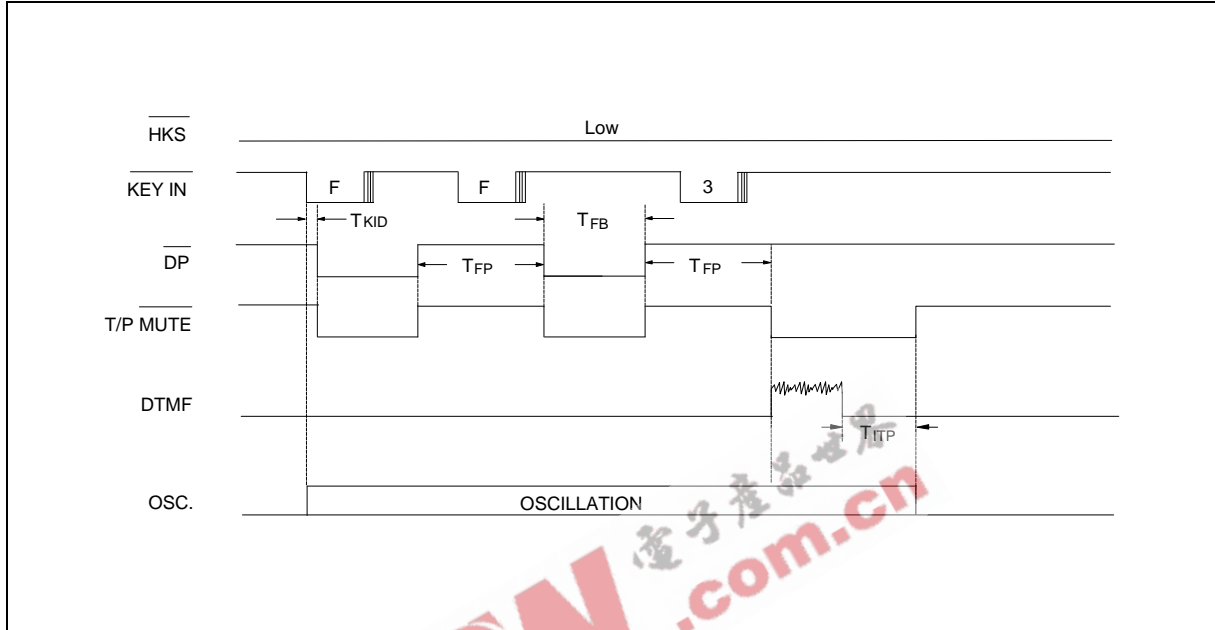

Figure 5. Flash Timing Diagram

# W91460N SERIES



EEPW 电子產品世界  
.com.cn



#### Headquarters

No. 4, Creation Rd. III,  
Science-Based Industrial Park,  
Hsinchu, Taiwan  
TEL: 886-3-5770066  
FAX: 886-3-5792697  
<http://www.winbond.com.tw/>  
Voice & Fax-on-demand: 886-2-7197006

#### Taipei Office

11F, No. 115, Sec. 3, Min-Sheng East Rd.,  
Taipei, Taiwan  
TEL: 886-2-7190505  
FAX: 886-2-7197502

#### Winbond Electronics (H.K.) Ltd.

Rm. 803, World Trade Square, Tower II,  
123 Hoi Bun Rd., Kwun Tong,  
Kowloon, Hong Kong  
TEL: 852-27516023  
FAX: 852-27552064

#### Winbond Electronics North America Corp.

Winbond Memory Lab.  
Winbond Microelectronics Corp.  
Winbond Systems Lab.  
2730 Orchard Parkway, San Jose,  
CA 95134, U.S.A.  
TEL: 1-408-9436666  
FAX: 1-408-9436668

Note: All data and specifications are subject to change without notice.