

W91210 SERIES



TONE/PULSE DIALER WITH REDIAL FUNCTION

GENERAL DESCRIPTION

The W91210 series are Si-gate CMOS ICs that provide the necessary signals for either pulse or tone dialing. The W91210 series features a redial function.

FEATURES

- DTMF/Pulse switchable dialer
- One by 32 digits for redial memory
- Pulse-to-tone (*T) keypad for long distance call operation
- Uses 4 × 4 keyboard
- Easy operation with redial, flash, pause, and *T keypads
- Pause, P→T (pulse-to-tone) can be stored as a digit in memory
- Minimum tone output duration: 87 mS
- Minimum intertone pause: 87 mS
- Flash time (100 mS, 300 mS or 600 mS) selectable by keypad
- Pause time 3.6 sec or 2.0 sec
- On-chip power-on reset
- Uses 3.579545 MHz crystal or ceramic resonator
- Packaged in 16-pin plastic DIP
- The different dialers in the W91210 series are described in the following table:

TYPE NO.	PULSE (ppS)	FLASH (mS)	PAUSE TIME (S)	M/B	PULSE-TO-TONE PAUSE TIME
W91212	10	100/300/600	3.6	Pin	Yes
W91214/A	10	100/300/600	3.6/2.0	Pin	No
W91216	10	100/300/600	3.6	Pin	Yes

Note: W91214 designed for use in France, W91216 for Germany.

W91210 SERIES



PIN CONFIGURATION

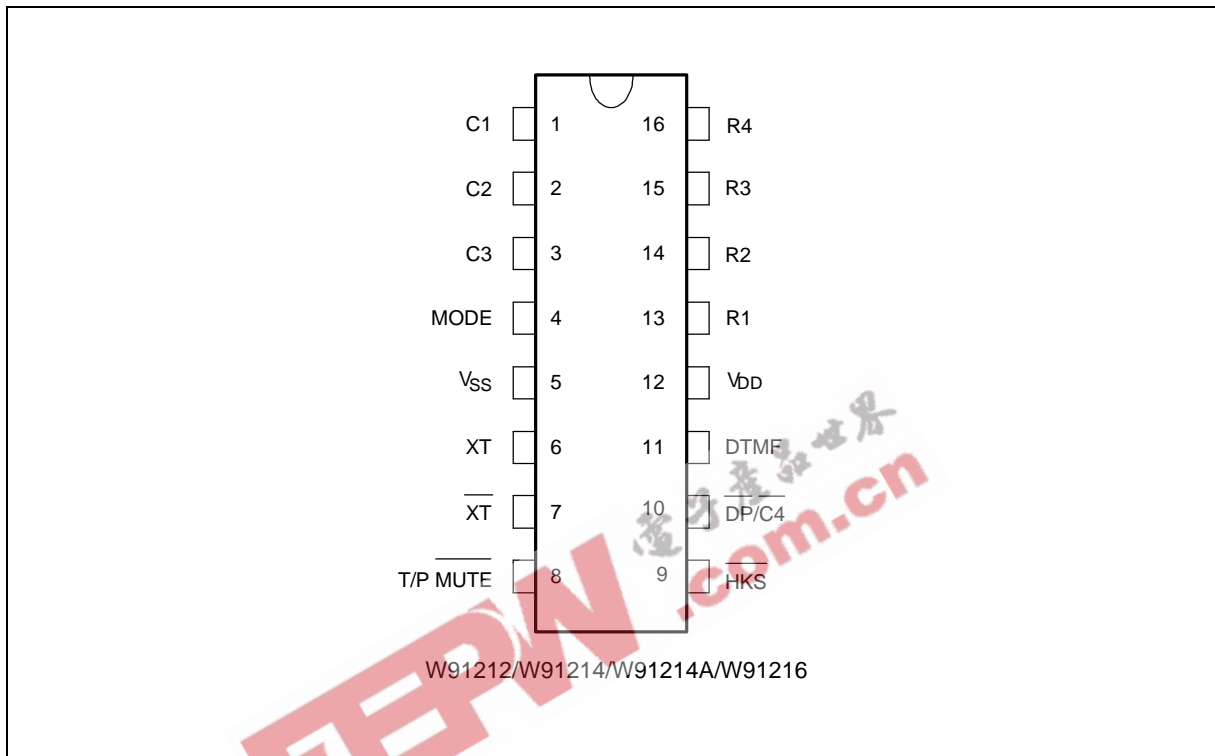

PIN DESCRIPTION

SYMBOL	16-PIN	I/O	FUNCTION
Column-Row Inputs	1-3 & 13-16	I	The keyboard input may be from either the standard 4 × 4 keyboard or an inexpensive single contact (form A) keyboard. Electronic input from a μ C can also be used. A valid key entry is defined by a single row being connected to a single column.
XT, $\overline{\text{XT}}$	6, 7	I, O	A built-in inverter provides oscillation with an inexpensive 3.579545 MHz crystal or ceramic resonator.
T/P $\overline{\text{MUTE}}$	8	O	The T/P $\overline{\text{MUTE}}$ is a conventional CMOS N-channel open drain output. The output transistor is switched on during pulse and tone mode dialing sequences and flash break. Otherwise, it is switched off.
MODE	4	I	Pulling mode pin to V_{SS} places the dialer in tone mode. Pulling mode pin to V_{DD} places the dialer in pulse mode (10 ppS, M/B = 2:3). If the mode pin is left floating, the dialer is in pulse mode (10 ppS, M/B = 1:2).

W91210 SERIES



Pin Description, continued

SYMBOL	16-PIN	I/O	FUNCTION																																				
$\overline{\text{HKS}}$	9	I	Hook switch input. $\overline{\text{HKS}} = 1$: On-hook state. Chip in sleep mode, no operation. $\overline{\text{HKS}} = 0$: Off-hook state. Chip enabled for normal operation. $\overline{\text{HKS}}$ pin is pulled to VDD by internal resistor.																																				
$\overline{\text{DP/C4}}$	10	O	N-channel open drain dialing pulse output (Figure 1). Flash key will cause $\overline{\text{DP}}$ to be active in either tone mode or pulse mode.																																				
DTMF	11	O	In pulse mode, remains in low state. In tone mode, outputs a dual or single tone. Detailed timing diagram for tone mode is shown in Figure 2(a, b). <table border="1" data-bbox="609 896 1286 1256"> <thead> <tr> <th colspan="4">OUTPUT FREQUENCY</th> </tr> <tr> <th></th> <th>Specified</th> <th>Actual</th> <th>Error %</th> </tr> </thead> <tbody> <tr> <td>R1</td> <td>697</td> <td>699</td> <td>+0.28</td> </tr> <tr> <td>R2</td> <td>770</td> <td>766</td> <td>-0.52</td> </tr> <tr> <td>R3</td> <td>852</td> <td>848</td> <td>-0.47</td> </tr> <tr> <td>R4</td> <td>941</td> <td>948</td> <td>+0.74</td> </tr> <tr> <td>C1</td> <td>1209</td> <td>1216</td> <td>+0.57</td> </tr> <tr> <td>C2</td> <td>1336</td> <td>1332</td> <td>-0.30</td> </tr> <tr> <td>C3</td> <td>1477</td> <td>1472</td> <td>-0.34</td> </tr> </tbody> </table>	OUTPUT FREQUENCY					Specified	Actual	Error %	R1	697	699	+0.28	R2	770	766	-0.52	R3	852	848	-0.47	R4	941	948	+0.74	C1	1209	1216	+0.57	C2	1336	1332	-0.30	C3	1477	1472	-0.34
OUTPUT FREQUENCY																																							
	Specified	Actual	Error %																																				
R1	697	699	+0.28																																				
R2	770	766	-0.52																																				
R3	852	848	-0.47																																				
R4	941	948	+0.74																																				
C1	1209	1216	+0.57																																				
C2	1336	1332	-0.30																																				
C3	1477	1472	-0.34																																				
VDD, VSS	12, 5	I	Power input pins.																																				

BLOCK DIAGRAM

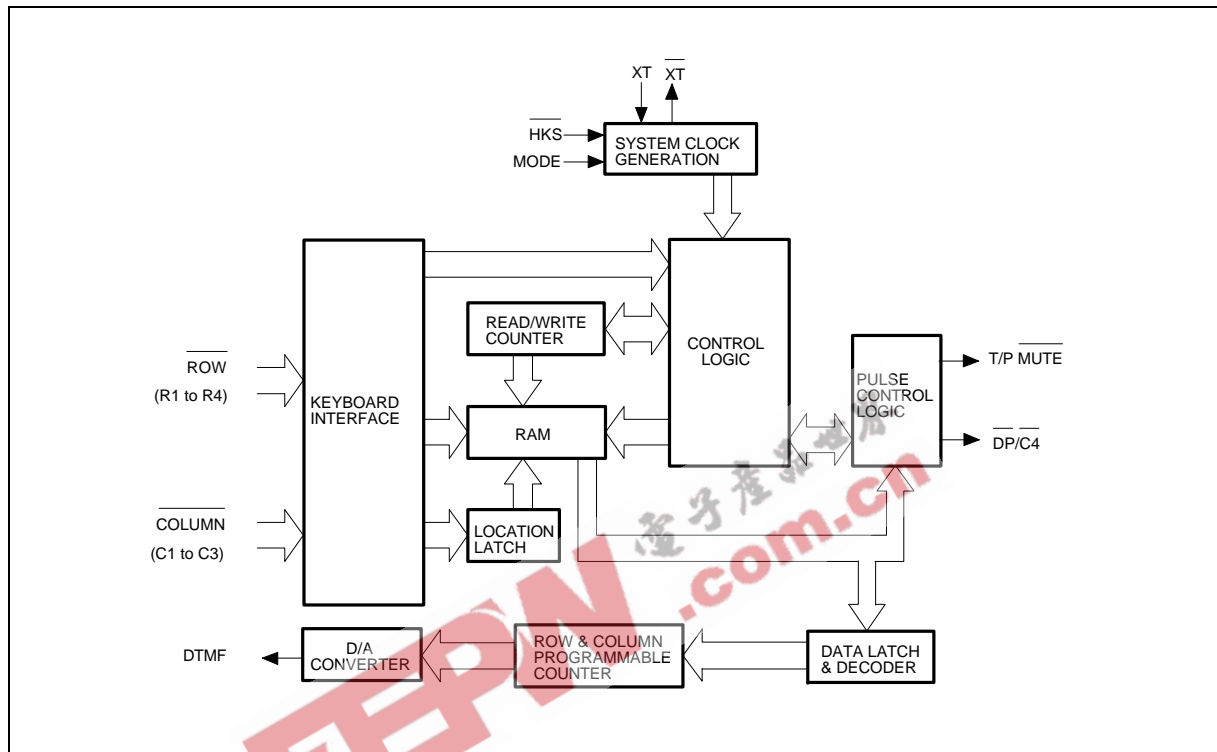

FUNCTIONAL DESCRIPTION

Keyboard Operation

C1	C2	C3	$\overline{DP/C4}$	
1	2	3	F1	R1
4	5	6	F2	R2
7	8	9	F3	R3
* / T	0	#	R / P	R4

- * / T: * and P → T key
- R / P: Redial and pause function key
- F1, F2, F3: Flash keys

Normal Dialing

OFF HOOK , D1 , D2 , ..., Dn

1. D1, D2, ..., Dn will be dialed out.
2. Dialing length is unlimited, but redial is inhibited if length oversteps 32 digits.

W91210 SERIES



Redialing

OFF HOOK , D1 , D2 , ..., Dn BUSY, Come ON HOOK , OFF HOOK , R/P

The R/P key can execute the redial function only as the first key-in after off-hook; otherwise, it ex-

ecutes the pause function.

Access Pause

OFF HOOK , D1 , D2 , R/P , D3 , ..., Dn

1. The pause function can be stored in memory.
2. The pause function is executed in normal dialing, redialing, or memory dialing.
3. The pause function timing diagram is shown in Figure 3.

Pulse-to-tone (* / T)

OFF HOOK , D1 , D2 , ..., Dn , */T , D1' , D2' , ..., Dn'

1. If the mode switch is set to pulse mode, then the output signal will be:
D1, D2, ..., Dn, Pause , D1', D2', ..., Dn'
(Pulse) (Tone)
2. If the mode switch is set to tone mode, then the output signal will be:
D1, D2, ..., Dn, * , D1', D2', ..., Dn'
(Tone) (Tone) (Tone)
3. The dialer remains in tone mode when the digits have been dialed out and can be reset to pulse mode only by going on-hook.
4. The P→T function timing diagram is shown in Figure 4(a, b).

Flash

OFF HOOK , F

1. The flash key cannot be stored as a digit in memory. The flash key has first priority among the keyboard functions.
2. The system will return to the initial state after the flash pause time is finished.
3. The flash function timing diagram is shown in Figure 5.

OFF HOOK , F , D1 , D2 , D3 , ..., Dn

LNB = D1, D2, D3, ..., Dn

OFF HOOK , D1 , D2 , F , D3 , ..., Dn

LNB = D3, ..., Dn

W91210 SERIES



ABSOLUTE MAXIMUM RATINGS

PARAMETER	SYMBOL	RATING	UNIT
DC Supply Voltage	VDD-VSS	-0.3 to +7.0	V
Input/Output Voltage	VIL	VSS -0.3	V
	VIH	VDD +0.3	V
	VOL	VSS -0.3	V
	VOH	VDD +0.3	V
Power Dissipation	PD	120	mW
Operating Temperature	TOPR	-20 to +70	°C
Storage Temperature	TSTG	-55 to +125	°C

Note: Exposure to conditions beyond those listed under Absolute Maximum Ratings may adversely affect the life and reliability of the device.

DC CHARACTERISTICS

(VDD-VSS = 2.5V, Fosc. = 3.58 MHz, TA = 25° C, all outputs unloaded)

PARAMETER	SYM.	CONDITIONS	MIN.	TYP.	MAX.	UNIT
Operating Voltage	VDD	-	2.0	-	5.5	V
Operating Current	IOP	Tone	-	0.30	1.0	mA
		Pulse	-	0.15	0.5	mA
Standby Current	ISB	$\overline{\text{HKS}} = 0$, No load & No key entry	-	-	15	μA
Memory Retention Current	IMR	$\overline{\text{HKS}} = 1$, VDD = 1.0V	-	-	0.2	μA
DTMF Output Voltage	VTO	Row group, RL = 5 KΩ	130	150	170	mVrms
Pre-emphasis		Col/Row, VDD = 2.0 to 5.5V	1	2	3	dB
DTMF Distortion	THD	RL = 5 KΩ, VDD = 2.0 to 5.5V	-	-30	-23	dB
DTMF Output DC Level	VTDC	RL = 5 KΩ, VDD = 2.0 to 5.5V	1.0	-	3.0	V
DTMF Output Sink Current	ITL	VTO = 0.5V	0.2	-	-	mA
$\overline{\text{DP}}$ Output Sink Current	IPL	VPO = 0.5V	0.5	-	-	mA
T/P $\overline{\text{MUTE}}$ Output Sink Current	IML	VMO = 0.5V	0.5	-	-	mA
$\overline{\text{HKS}}$ I/P Pull-High Resistor	RKH		-	300	500	KΩ
Keypad Input Drive Current	IKD	VI = 0V	30	-	-	μA
Keypad Input Sink Current	IKS	VI = 2.5V	200	400	-	μA
Keypad Resistance			-	-	5.0	KΩ

W91210 SERIES



AC CHARACTERISTICS

PARAMETER	SYM.	CONDITIONS	MIN.	TYP.	MAX .	UNIT
Keypad Active in Debounce	TKID		-	20	-	mS
Key Release Debounce	TKRD		-	20	-	mS
Pre-digit Pause	TPDP	Mode Pin = VDD	-	40	-	mS
		Mode Pin = Floating	-	33.3	-	mS
Interdigit Pause (Auto dialing)	TIDP	10 ppS	-	800	-	mS
Make/Break Ratio	M/B	Mode Pin = VDD	-	40:60	-	%
		Mode Pin = Floating	-	33:67	-	%
DTMF Output Duration	TTD	Auto Dialing	85	87	-	mS
Intertone Pause	TITP	Auto Dialing	85	87	-	mS
Flash Break Time	TFB	F1	-	100	-	mS
		F2	-	300	-	
		F3	-	600	-	
Flash Pause Time	TFP	F1	-	1.0	-	S
		F2	-	1.0	-	
		F3	-	1.0	-	
Pause Time	TP	W91212/214/216	-	3.6	-	S
		W91214A	-	2.0	-	

Notes:

- Crystal parameters suggested for proper operation are $R_s < 100 \Omega$, $L_m = 96 \text{ mH}$, $C_m = 0.02 \text{ pF}$, $C_n = 5 \text{ pF}$, $C_l = 18 \text{ pF}$, $F_{osc} = 3.579545 \text{ MHz} \pm 0.02\%$.
- Crystal oscillator accuracy directly affects these times

TIMING WAVEFORMS

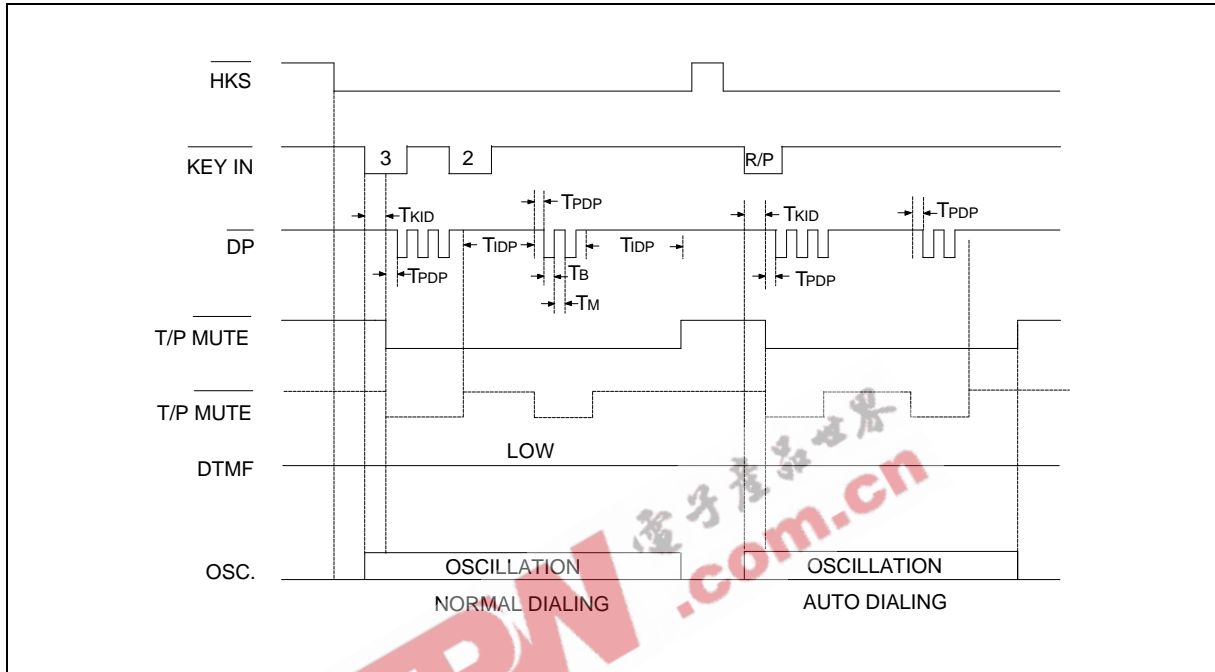

Figure 1. Pulse Mode Timing Diagram

Note: The dashed line is for W91216 only in pulse mode.

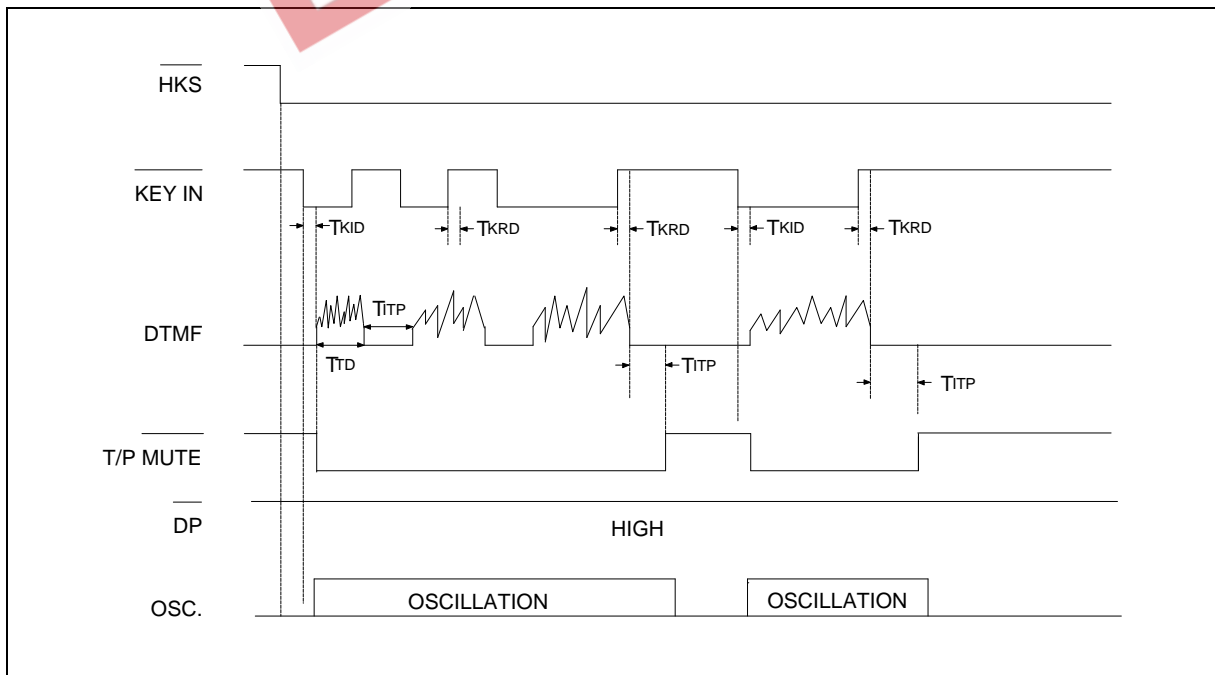

Figure 2(a). Tone Mode Normal Dialing Timing Diagram

W91210 SERIES



Timing Waveforms, continued

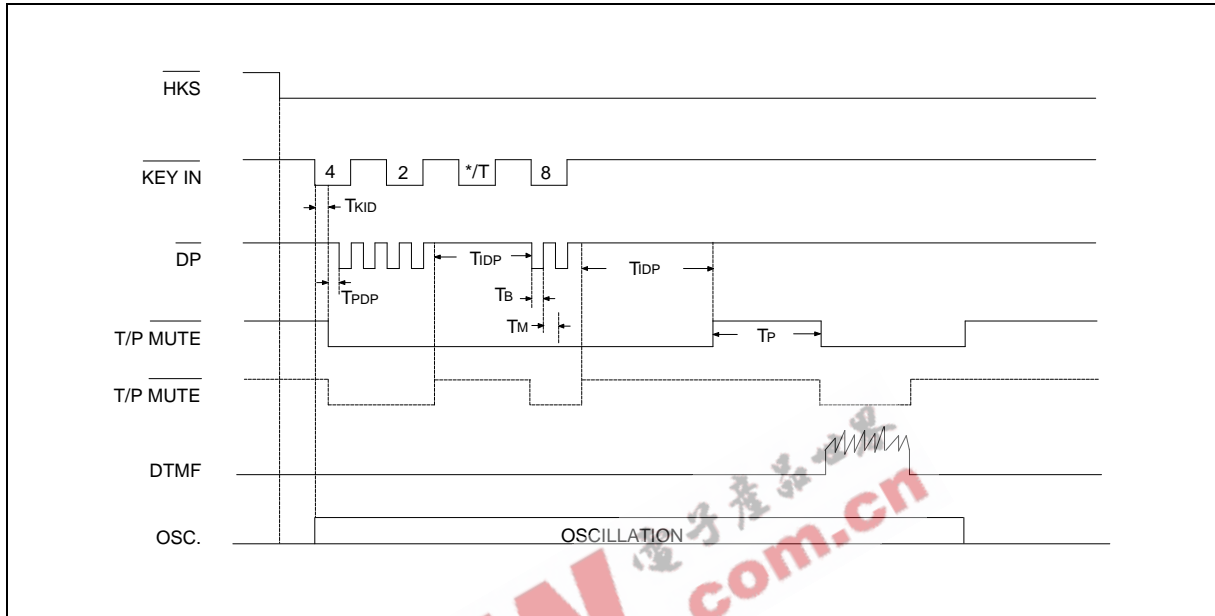

Figure 4(a). P→T Operation Timing Diagram in Normal Dialing (W91212, W91216)

Note: The dashed line is for W91216 only.

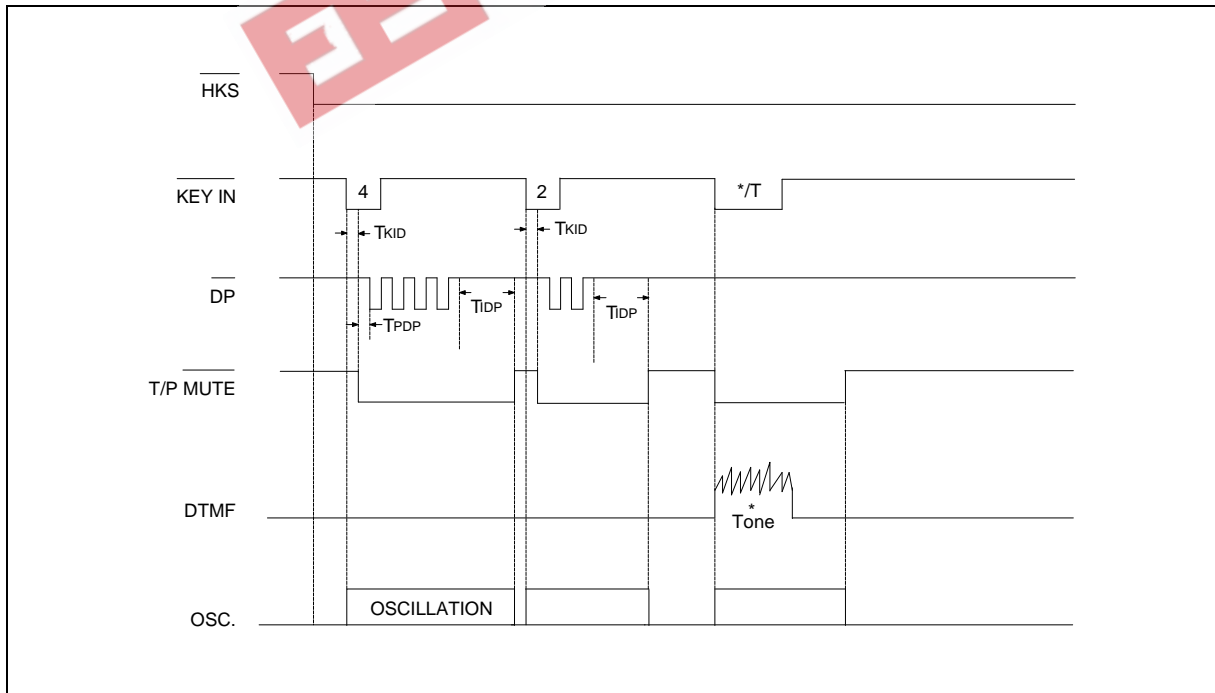

Figure 4(b). P→T Operation Timing Diagram in Normal Dialing (for W91214/W91214A)

W91210 SERIES



Timing Waveforms, continued

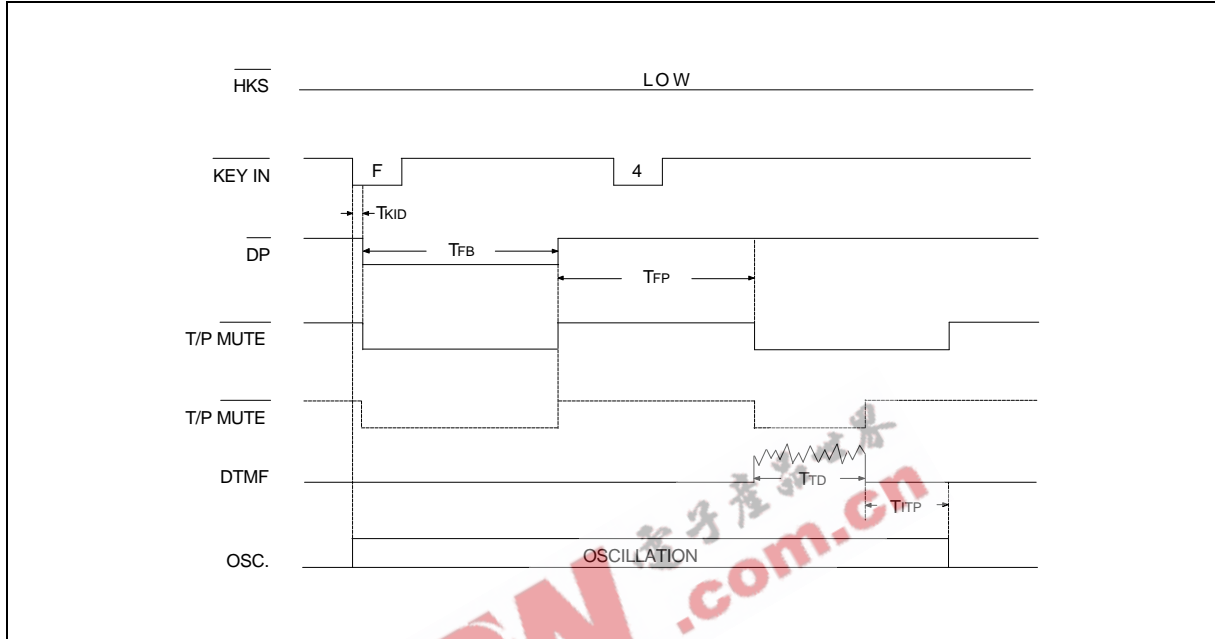

Figure 5. Flash Operation Timing Diagram

Note: The dashed line is for W91216 only.

W91210 SERIES



EEPW 电子產品世界
.com.cn



Headquarters

No. 4, Creation Rd. III,
Science-Based Industrial Park,
Hsinchu, Taiwan
TEL: 886-3-5770066
FAX: 886-3-5792697
<http://www.winbond.com.tw/>
Voice & Fax-on-demand: 886-2-7197006

Taipei Office

11F, No. 115, Sec. 3, Min-Sheng East Rd.,
Taipei, Taiwan
TEL: 886-2-7190505
FAX: 886-2-7197502

Winbond Electronics (H.K.) Ltd.

Rm. 803, World Trade Square, Tower II,
123 Hoi Bun Rd., Kwun Tong,
Kowloon, Hong Kong
TEL: 852-27516023
FAX: 852-27552064

Winbond Electronics North America Corp.

Winbond Memory Lab.
Winbond Microelectronics Corp.
Winbond Systems Lab.
2730 Orchard Parkway, San Jose,
CA 95134, U.S.A.
TEL: 1-408-9436666
FAX: 1-408-9436668

Note: All data and specifications are subject to change without notice.