



Specification WH2001

Preliminary

EEPW 电子产品世界
.com.cn

SSC		CUSTOMER
Drawn	Approval	Approval

Rev. 00

September 2008

www.ZLED.com

Document No. : SSC-QP-7-07-24 (Rev.00)



CONTENTS

1. Absolute Maximum Ratings
2. Electro Characteristics
3. Outline Dimension
4. Electro-Optical characteristic Diagram
5. Color & Binning
6. Rank of WH603R
7. Reliability tests
8. Packing
9. Soldering
10. Precaution for use

EEPW 电子产品世界 .com.cn



WH2001

WH2001

Description

- Vary Thin PKG of Reflector type
- Surface-mounted chip LED device.
- Pb-free and RoHS complaint component.
- High brightness
- Low Thermal Resistance
- Tape and Reel packing.

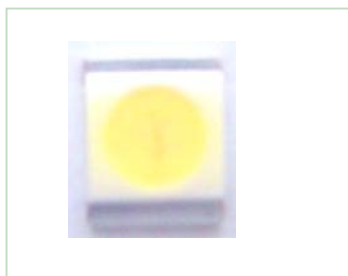

Features

- 3.5 X 2.8 X 0.6 mm
- Emitted Color : White
- CIE chromaticity
x : 0.3 y : 0.3
- Material : InGaN

Applications

- Electric appliance
- Other decoration lighting

EEPW 电子产品世界 .com.cn

1. Absolute maximum ratings

(Ta=25°C)

Parameter	Symbol	Value	Unit
Power Dissipation	P_d	100	mW
Forward Current	I_F	30	mA
Peak Forward Current	I_{FM}^{*1}	90	mA
Reverse Voltage	V_R	5	V
Operation Temperature	$T_{opr.}$	-30 ~ 85	°C
Storage Temperature	$T_{stg.}$	-40 ~ 100	°C

*1 I_{FM} conditions: Pulse width $T_w \leq 0.1ms$ and Duty ratio $\leq 1/10$.

2. Electro-Optical Characteristics

(Ta=25°C)

Parameter	Symbol	Condition	Min	Typ	Max	Unit
Forward Voltage	V_F	$I_F=20\text{ mA}$	2.7	3.2	4.0	V
Reverse Current	I_R	$V_R=5V$	-	-	10	μA
Luminous Intensity ^{*2}	I_V	$I_F=20\text{ mA}$	-	1800	2600	mcd
Luminous Flux	Φ	$I_F=20\text{ mA}$	-	5	-	lm
Chromaticity Coordinates ^{*3}	x	$I_F=20\text{ mA}$	0.28	0.3	0.34	
	y	$I_F=20\text{ mA}$	0.25	0.3	0.34	
Viewing Angle ^{*4}	$2\theta_{1/2}$	$I_F=20\text{ mA}$	-	120	-	°

*2 The luminous intensity I_V is measured at the peak of the spatial pattern which may not be aligned with the mechanical axis of the LED package.

*3 The CIE standard colorimetric system

*4 $\theta_{1/2}$ is the off-axis where the luminous intensity is 1/2 the peak intensity.

[Note] All products conform to the listed minimum and maximum specifications for electric and optical characteristics, when operated at 20mA within the maximum ratings shown above. All measurements were made under the standardized environment of SSC.

(Tolerance : $I_V \pm 10\%$, color coordinate ± 0.01 , $V_F \pm 0.1V$)

Rev. 00

September 2008

www.ZLED.com

Document No. : SSC-QP-7-07-24 (Rev.00)

3.Outline Dimension

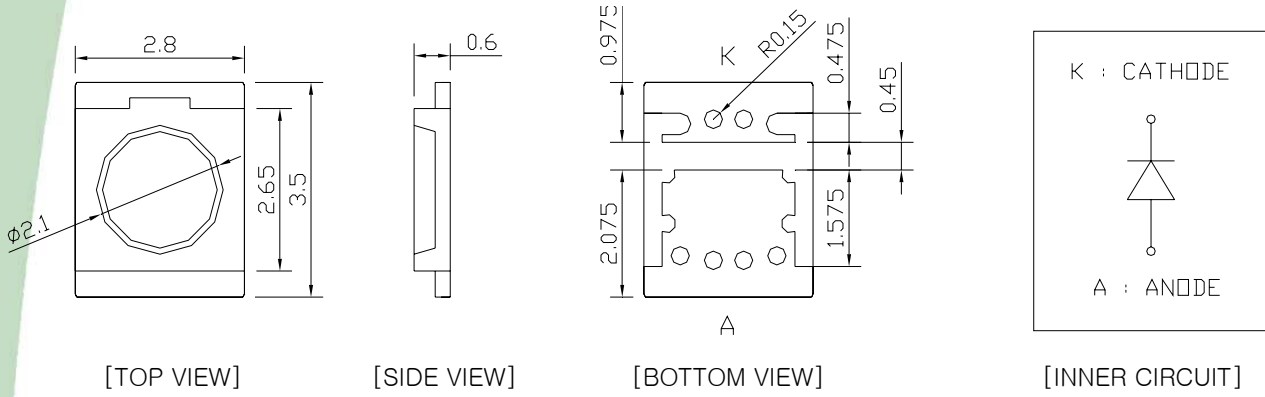

(Tolerance: ± 0.1 , Unit: mm)

- Recommended Soldering Design

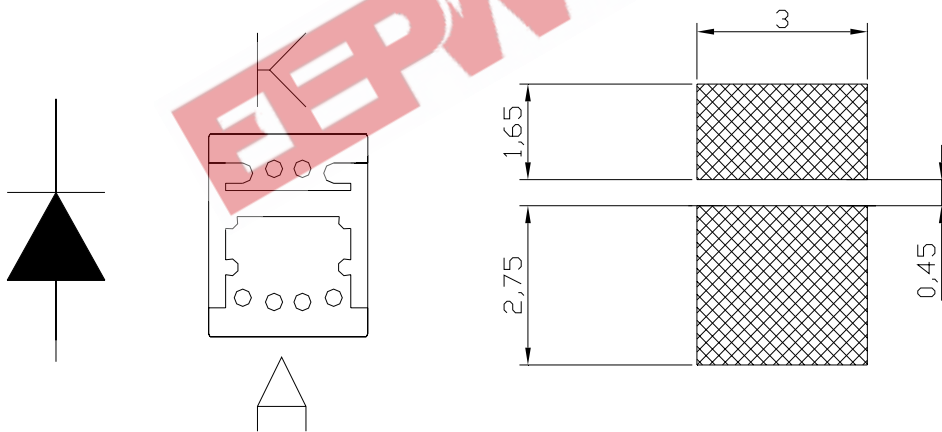

4. Electro-Optical characteristic Diagram

Forward Current vs. Forward Voltage

($T_a=25\text{ }^\circ\text{C}$)

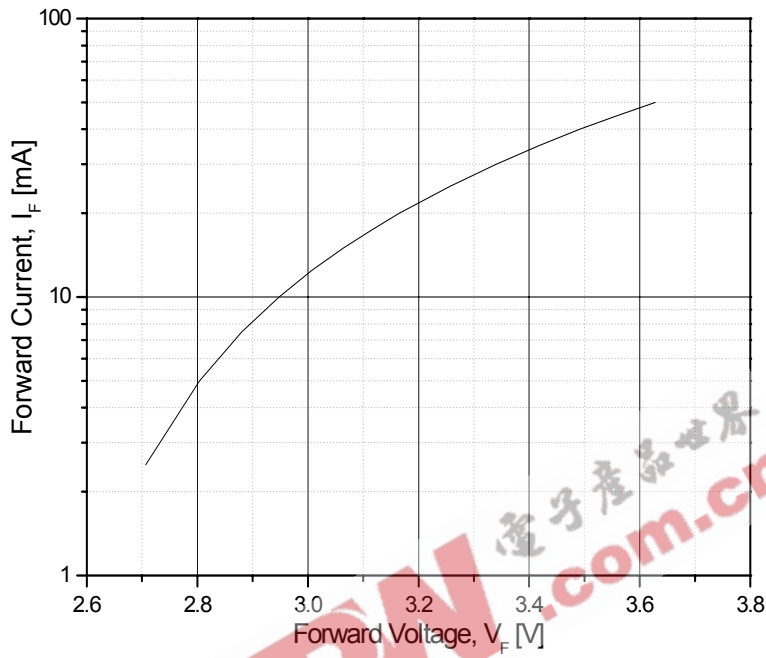

Relative Luminous Intensity vs Forward Current

($T_a=25\text{ }^\circ\text{C}$)

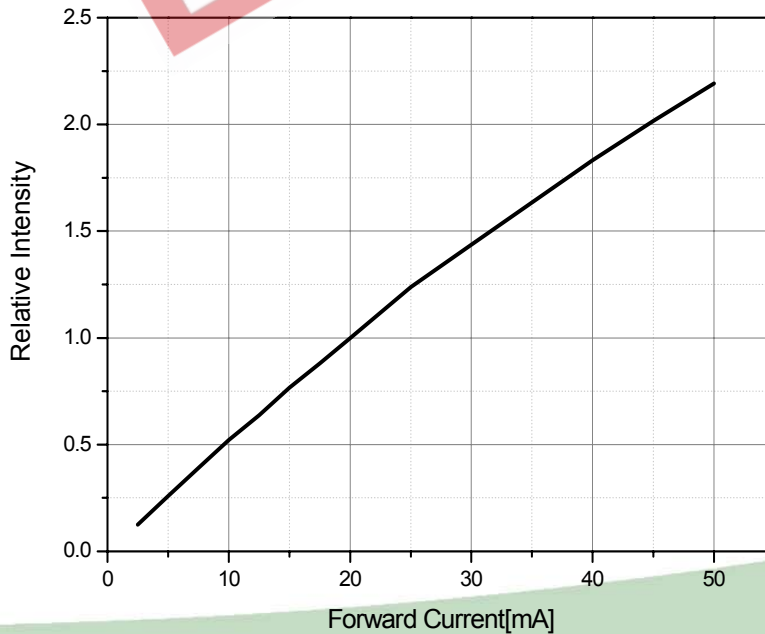

4. Electro-Optical characteristic Diagram

Ambient Temperature vs. Allowable Forward Current

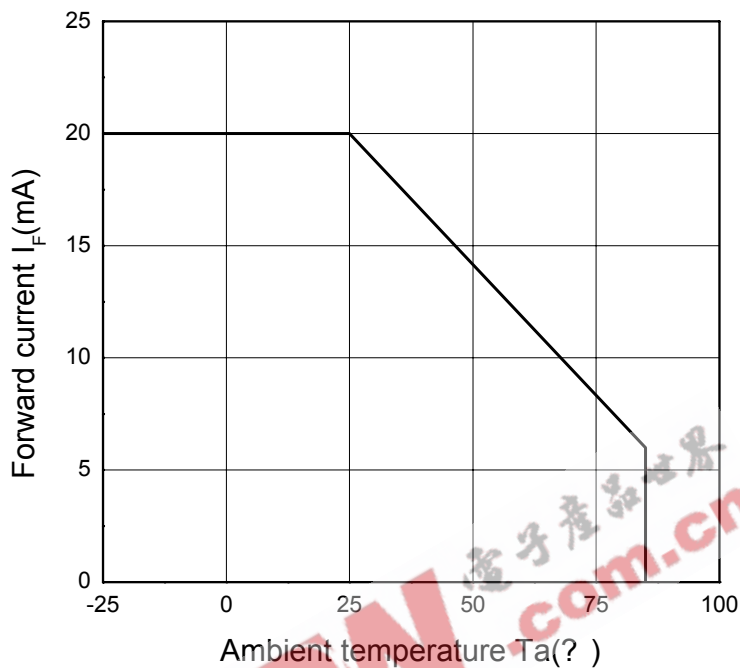

Radiation Diagram

($T_a=25\text{ }^\circ\text{C}$)

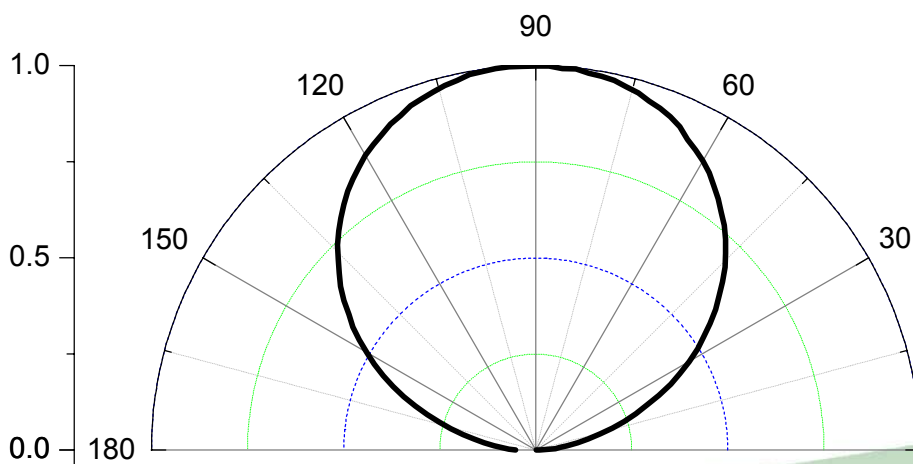

4. Electro-Optical characteristic Diagram

Spectrum

($T_A=25^{\circ}\text{C}$, $I_F=20\text{mA}$)

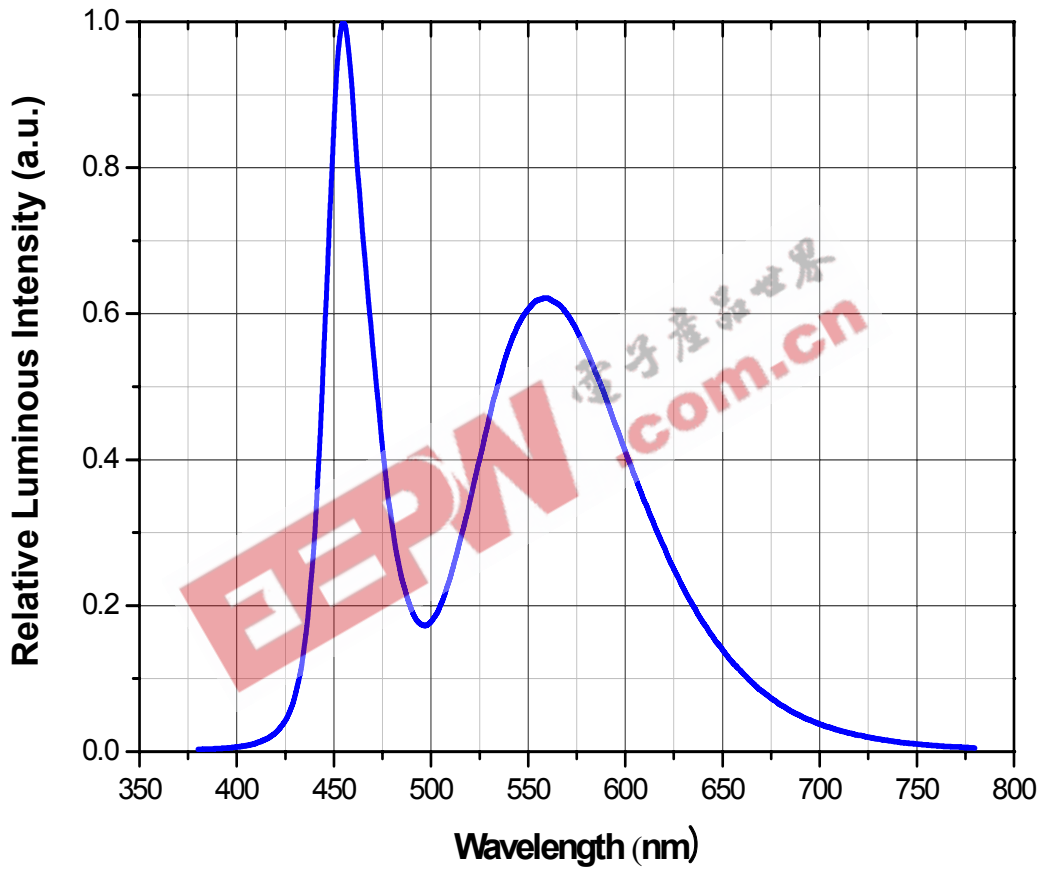

5. Color & Binning

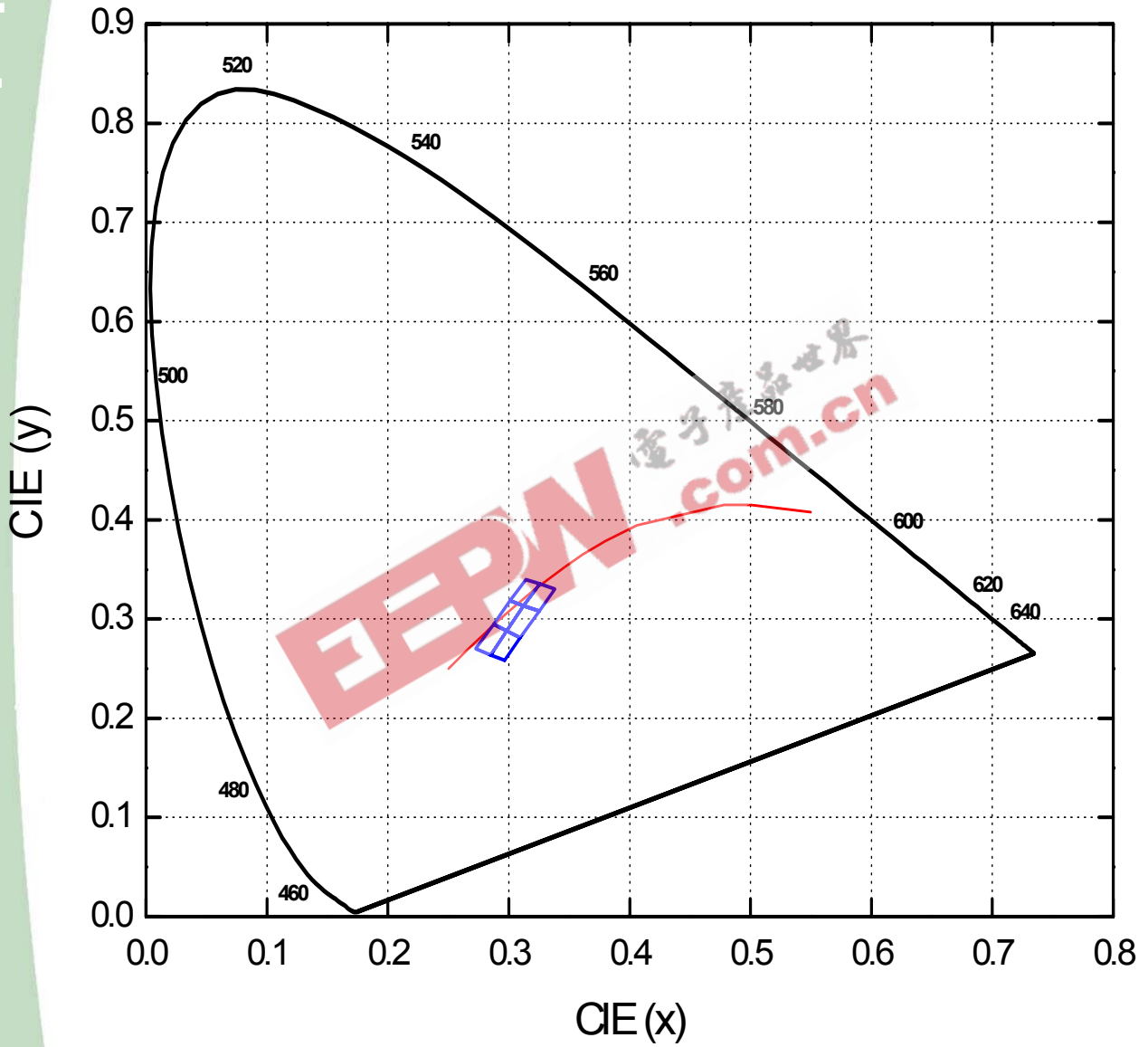

5. Color & Binning

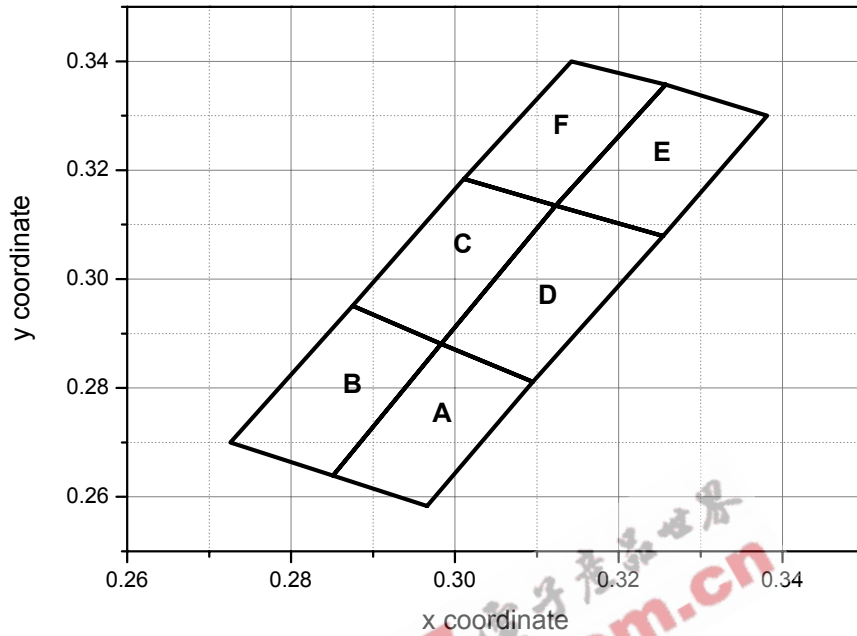

※ **Color Rank**

Bin	CIE x	CIE y	Bin	CIE x	CIE y	Bin	CIE x	CIE y
A	0.2966	0.2583	B	0.2851	0.2639	C	0.2983	0.2881
	0.2851	0.2639		0.2726	0.2700		0.2875	0.2951
	0.2983	0.2881		0.2875	0.2951		0.3011	0.3184
	0.3095	0.2811		0.2983	0.2881		0.3123	0.3135
D	0.3095	0.2811	E	0.3254	0.3079	F	0.3257	0.3357
	0.2983	0.2881		0.3381	0.3300		0.3123	0.3135
	0.3123	0.3135		0.3257	0.3357		0.3011	0.3184
	0.3254	0.3079		0.3123	0.3135		0.3142	0.3400

* Measurement Uncertainty of the Color Coordinates : ± 0.01

6. Rank of WH2001

(1) Luminous Intensity: I_v [mcd]

Rank	I_v [mcd]	Condition
A	1000 ~ 1550	IF =20mA
B	1550 ~ 2600	

(2) Color Coordinate: x, y

Rank		1	2	3	4	Condition
A	x	0.2966	0.2851	0.2983	0.3095	IF =20mA
	y	0.2583	0.2639	0.2881	0.2811	
B	x	0.2851	0.2726	0.2875	0.2983	
	y	0.2639	0.2700	0.2951	0.2881	
C	x	0.2983	0.2875	0.3011	0.3123	
	y	0.2881	0.2951	0.3184	0.3135	
D	x	0.3095	0.2983	0.3123	0.3254	
	y	0.2811	0.2881	0.3135	0.3079	
E	x	0.3254	0.3381	0.3257	0.3123	
	y	0.3079	0.3300	0.3357	0.3135	
F	x	0.3257	0.3123	0.3011	0.3142	
	y	0.3357	0.3135	0.3184	0.3400	

(3) Forward voltage: V_F

V_F [V]	Condition
2.8 ~ 3.8	IF =20mA

7. Reliability Tests

Item	Condition	Note	Failures
Life Test	$T_a = RT, I_F = 20mA$	1000hrs	0/22
High Temperature Operating	$T_a = 85^{\circ}C, I_F = 20mA$	1000hrs	0/22
Low Temperature Operating	$T_a = -30^{\circ}C, I_F = 20mA$	1000hrs	0/22
Thermal Shock	$T_a = -30^{\circ}C$ (30min) ~ $85^{\circ}C$ (30min) (Transfer time : 10sec, 1Cycle = 1hr)	100 cycles	0/40
Resistance to soldering Heat	$T_s = 255 \pm 5^{\circ}C, t = 10sec$	1 time	0/22
ESD (Human Body Model)	1kV, 1.5k Ω ; 100pF	1 time	0/22
High Temperature Storage	$T_a = 100^{\circ}C$	1000hrs	0/22
Low Temperature Storage	$T_a = -40^{\circ}C$	1000hrs	0/22
Temperature Humidity Storage	$T_a = 85^{\circ}C, RH = 85%$	1000hrs	0/22
Temperature Humidity Operating	$T_a = 85^{\circ}C, RH = 85%, I_F = 20mA$	100hrs	0/22

< Judging Criteria For Reliability Tests >

V_F	USL ^[1] X 1.2
I_R	USL X 2.0
Φ_V	LSL ^[2] X 0.7

Notes :

[1] USL : Upper Standard Level

[2] LSL : Lower Standard Level.

8. Packing

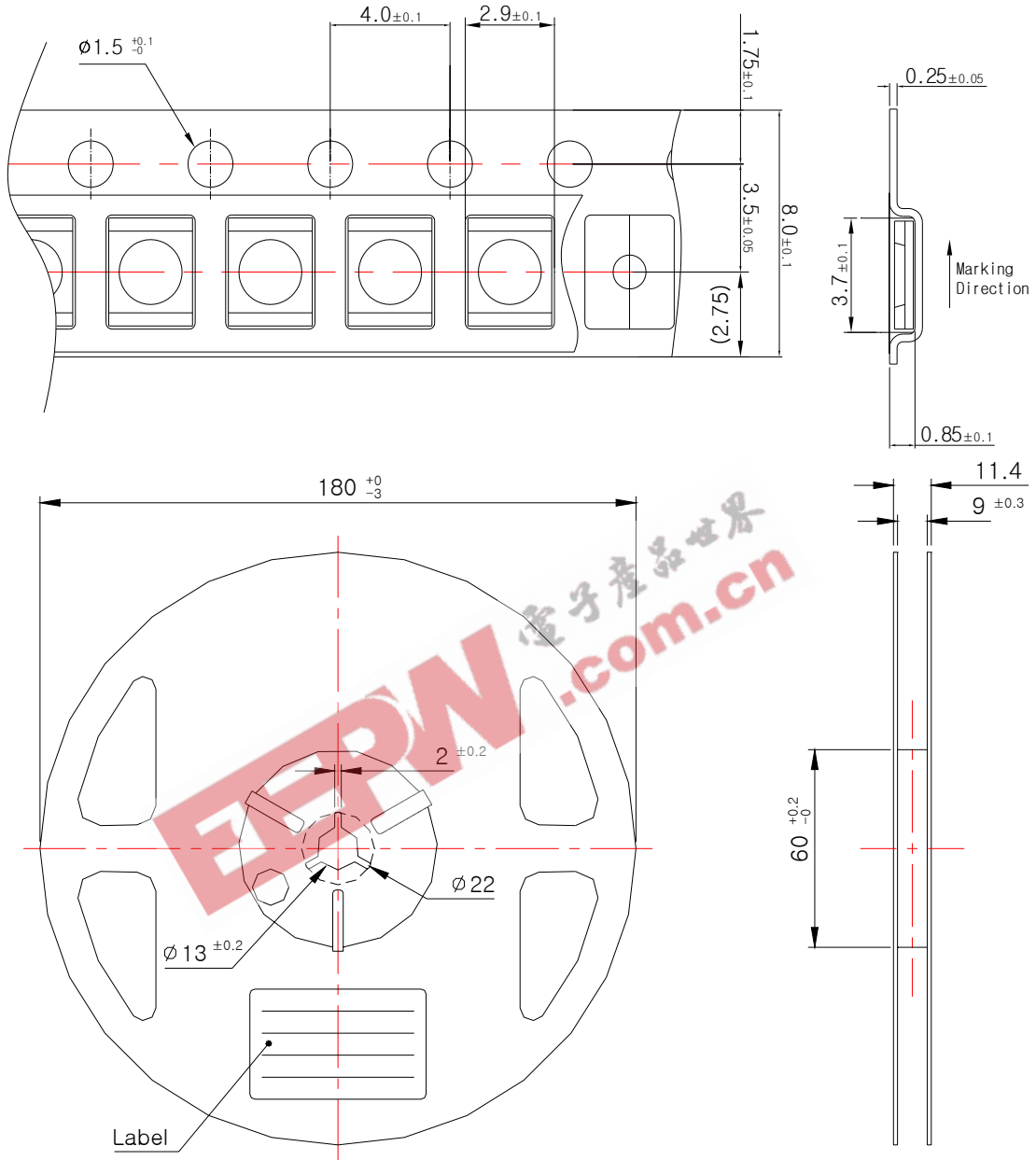

- (1) Quantity: 2,000pcs./Reel
- (2) Cumulative Tolerance: Cumulative Tolerance/10pitches to be ± 0.2 mm
- (3) Adhesion Strength of Cover Tape: Adhesion strength to be 0.1-0.7N when the over tape is turned off from the carrier tape at 10° angle to be the carrier tape.
- (4) Package: P/N, Manufacturing data Code No. and quantity to be indicated on a damp proof Package.

Rev. 00

September 2008

www.ZLED.com

Document No. : SSC-QP-7-07-24 (Rev.00)

● Reel Packing Structure

Reel

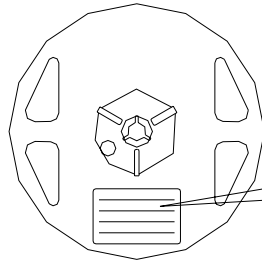

Product No.: SSC-WH2001 ##
 Quantity : 2000
 Batch/Lot number : #####



Aluminum Vinyl Bag

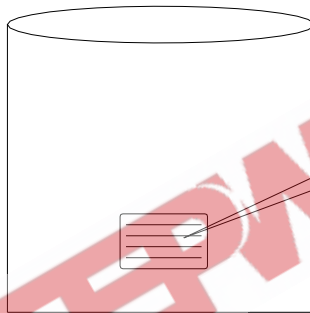

Product No.: SSC-WH2001 ##
 Quantity : 2000
 Batch/Lot number : #####



Outer Box

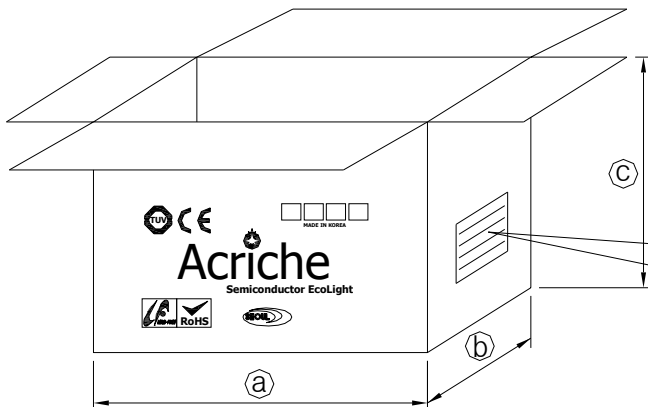

*Material: Paper(SW3B(B))

TYPE	SIZE(mm)		
	(a)	(b)	(c)
7 inch	245	220	142

CHIP LED

PART : SSCWh2001
 CODE :
 Q'YT : 20,000EA
 LOT NO :
 DATE :
 SEOUL SEMICONDUCTOR CO.,LTD

9. Soldering

(1) Lead Solder

Lead Solder	
Pre-heat	120~150℃
Pre-heat time	120 sec. Max.
Peak-Temperature	240℃ Max.
Soldering time Condition	10 sec. Max.

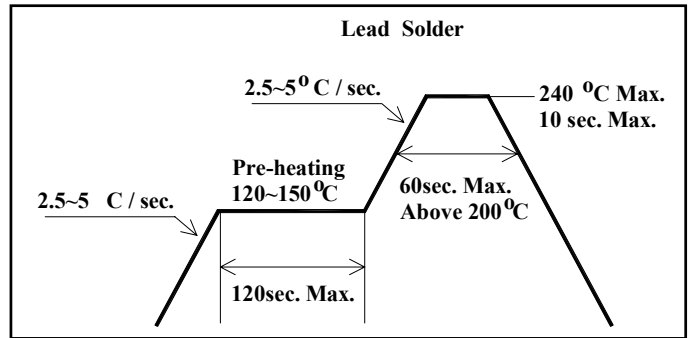

(2) Lead-Free Solder

Lead Free Solder	
Pre-heat	150~200℃
Pre-heat time	120 sec. Max.
Peak-Temperature	260℃ Max.
Soldering time Condition	10 sec. Max.

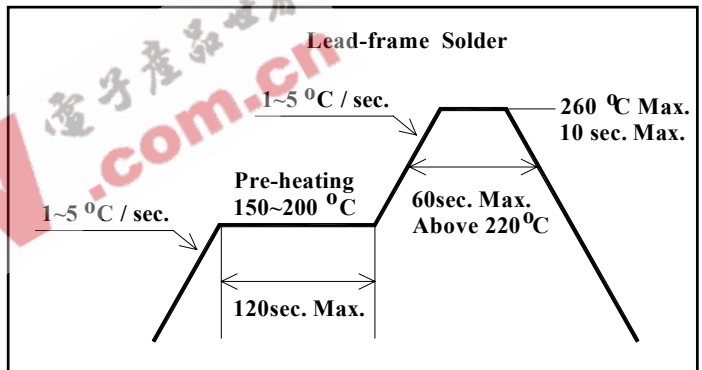

(3) Hand Soldering conditions

Do not exceed 3 seconds at maximum 280°C under soldering iron.

(4) The encapsulated material of the LEDs is silicone.

Precautions should be taken to avoid the strong pressure on the encapsulated part.

So when using the chip moulder, the picking up nozzle that does not affect the silicone resin should be used.

Note : In case that the soldered products are reused in soldering process, we don't guarantee the products.

10. Precaution for use

(1) Storage

In order to avoid the absorption of moisture, it is recommended to store in the dry box (or desiccator) with a desiccant. Otherwise, to store them in the following environment is recommended.

Temperature : 5°C~30°C Humidity : 60%HR max.

(2) Attention after opened

However LED is corresponded SMD, when LED be soldered dip, interfacial separation may affect the light transmission efficiency, causing the light intensity to drop. Attention in followed.

a. After opened and mounted, the soldering shall be quickly.

b. Keeping of a fraction

Temperature : 5 ~ 40°C Humidity : less than 30%

(3) In case of more than 1 week passed after opening or change color of indicator on desiccant components shall be dried 10-12hr. at 60±5°C.

(4) In case of supposed the components is humid, shall be dried dip-solder just before.

100Hr at 80±5°C or 12Hr at 100±5°C.

(5) Any mechanical force or any excess vibration shall not be accepted to apply during cooling process to normal temp. after soldering.

(6) Quick cooling shall not be avoid.

(7) Components shall not be mounted on warped direction of PCB.

(8) Anti radioactive ray design is not considered for the products listed here in.

(9) Gallium arsenide is used in some of the products listed in this publication. These products are dangerous if they are burned or smashed in the process of disposal. It is also dangerous to drink the liquid or inhale the gas generated by such products when chemically disposed.

(10) This device should not be used in any type of fluid such as water, oil, organic solvent and etc. When washing is required, IPA should be used.

(11) When the LEDs are illuminating, operating current should be decided after considering the ambient maximum temperature.

(12) LEDs must be stored to maintain a clean atmosphere. If the LEDs are stored for 3 months or more after being shipped from SSC, a sealed container with a nitrogen atmosphere should be used for storage.

(13) The LEDs must be soldered within seven days after opening the moisture-proof packing.

(14) Repack unused products with anti-moisture packing, fold to close any opening and then store in a dry place.

(15) The appearance and specifications of the product may be modified for improvement without notice.