

W536020K/030K/060K/090K/120K



VOICE/MELODY/LCD CONTROLLER (ViewTalk™ Series)

Table of Contents-

1.	GENERAL DESCRIPTION	2
2.	FEATURES	3
3.	BLOCK DIAGRAM	5
4.	PAD DESCRIPTION	6
5.	ELECTRICAL CHARACTERISTICS	9
5.1	Absolute Maximum Ratings	9
5.2	DC Characteristics	9
5.3	AC Characteristics	11
6.	TYPICAL APPLICATION CIRCUITS	14
6.1	Sub Clock with RC Mode	14
6.2	Sub Clock with Crystal Mode	15
7.	REVISION HISTORY	16

W536020K/030K/060K/090K/120K



1. GENERAL DESCRIPTION

The W536XXXK, a member of *ViewTalk™* family, is a high-performance 4-bit micro-controller (uC) with built-in speech unit, melody unit and 40seg * 8 com LCD driver unit which includes internal regulator, pump circuit and dedicated one page LCD RAM. The 4-bit uC core contains dual clock source, 4-bit ALU, two 8-bit timers, one 14 bits divider, maximum 24 pads for input or output, 8 interrupt sources and 8-level nesting for subroutine/interrupt applications. Speech unit, integrated as a single chip with maximum 128 seconds (based on 6.4K sample rate with 5 bits MDPCM), is capable of expanding to 512 seconds speech addressed by external memory W55XXX with serial bus interface.

It can be implemented with Winbond Power Speech using MDPCM algorithm. Melody unit provides dual tone output and can store up to 1k notes. Power reduction mode is also built in to minimize power dissipation. It is ideal for games, educational toys, remote controllers, watches, clocks and other application products which incorporate both LCD display and speech.

Body	W536020K	W536030K	W536060K	W536090K	W536120K
Voice	20 sec	30 sec	60 sec	90 sec	120 sec
I/O pad	4I/O, 8I (RA/RC/RD)	4I/O, 8I (RA/RC/RD)	8io, 8i (RA/RB/RC/RD)	8I/O, 8I, 8O (RA/RB/RC/RD/RE/RF)	8I/O, 8I, 8O (RA/RB/RC/RD/RE/RF)
WDT disable/Enable (Mask Option)	Y	Y	Y	Y	Y
Sub-clock RC/XTAL mode (Mask Option)	Y	Y	Y	Y	Y
RD port shared as serial bus (Mask Option)	Y(1)	Y(1)	N	N	N (2)
Tri-state serial bus (Mask Option) (3)	Y	Y	N	Y	Y
Cascaded Voice ROM through serial bus (2)	N	Y(1)	N	N	Y

Notes:

1. Share 3 pads of RD port (RD1/CLK, RD2/DATA and RD3/ADDR)
2. Dedicate serial bus 3 pads (CLK, DATA and ADDR) to interface with W55XXX. Cascaded Voice ROM can help to expand voice up to 512 sec by W55XXX chip.
3. Tri-state serial bus mask option can float serial bus while voice playing is no active. Let this mask option is disabled to get minimum power consumption in general.

W536020K/030K/060K/090K/120K



2. FEATURES

- Operating voltage: 2.4 volt ~ 5.5 volt
- Watch dog disabled/enabled by mask option
- Dual clock operating system
 - Main clock with Ring/Crystal (400 KHz to 4 MHz)
 - Sub-clock with 32.768 KHz RC/Crystal by mask option
- Memory
 - Program ROM (P-ROM): 16K × 20 (ROM Bank0)
 - Data RAM (W-RAM): 1K × 4 bit
(RAM Bank 0 is 512 nibbles from 0: 000~0: 1FF and 0: 380~0:3FF are mapped to special register.
RAM Bank F is 512 nibbles from F: 200~F: 3FF either data RAM or dedicated to script kernel)
 - LCD RAM (L-RAM): 80 × 4 bit (RAM Bank1 from 200~24F)
- Maximum 24 input/output pads
 - Ports for input only: 8 pads (RC, RD port; RD1~3 can share as serial bus for external memory W55XXX interface @W5360020/30K)
 - Ports for output only: 8 pads (RE & RF port; W536090K/120K available only)
 - Ports for Input/output: 8 pads (RA and RB port; RB port is available for W536060/090K/120K only)
- Power-down mode
 - Hold mode (except for 32KHz oscillator)
 - Stop mode (including 32KHz oscillator and release by RD or RC port)
- Eight types of interrupts
 - Five internal interrupts (Divider, Timer 0, Timer 1, Speech, Melody)
 - Three external interrupts (Port RC, RD, RA)
- One built-in 14-bit clock frequency divider circuit
- Two built-in 8-bit programmable countdown timers
 - Timer 0: one of two clock sources (FOSC/4 or FOSC/1024) can be selected
 - Timer 1: built-in auto-reload function includes internal timer, external event counter from RC.0
- Built-in 18/14-bit watchdog timer for system reset.
- Powerful instruction sets
- 8-level subroutine (including interrupt) nesting
- LCD driver unit capability
 - VLCD higher than ($V_{DD} - 0.5V$)
 - Built-in voltage regulator to V2 pad
 - 40 seg × 8 com

W536020K/030K/060K/090K/120K



- 1/8 or 1/4 duty, 1/4 or 1/3 bias, internal pump circuit option by special register
- COM 4~ 7 and SEG16~39 can be shared as general input/output by special register
- Either uC ROM or voice ROM used as LCD picture
- Speech function
 - Provided 640K / 1M/ 2M/ 3M/ 4M bits Voice ROM for W536020K/030K/060K/090K/120K based on 5 bits MDPCM algorithm
 - Voice ROM (V-ROM) available for uC data or LCD picture data.
 - Maximum 8*256 Label/Interrupt vector (voice section number) available
 - Provide two types of speech busy flag to either each GO or each trigger
 - Maximum up to 16M bits speech address capability interface with external memory W55XXX through serial bus.
- Melody function
 - Provide 1K notes (22bits/note) dedicated melody ROM
 - Provide two types of melody busy flag to uC either each note or each song
 - Provide 6 kinds of beat, 16 kinds of tempo, and pitch range from G3# to C7
 - Tremolo, triple frequency and 3 kinds of percussion available
 - Maximum 31 songs available
- Can mix speech with melody
- Multi-engine controller
- Direct driving speaker/buzzer or DAC output
- Chip On Board available

W536020K/030K/060K/090K/120K



3. BLOCK DIAGRAM

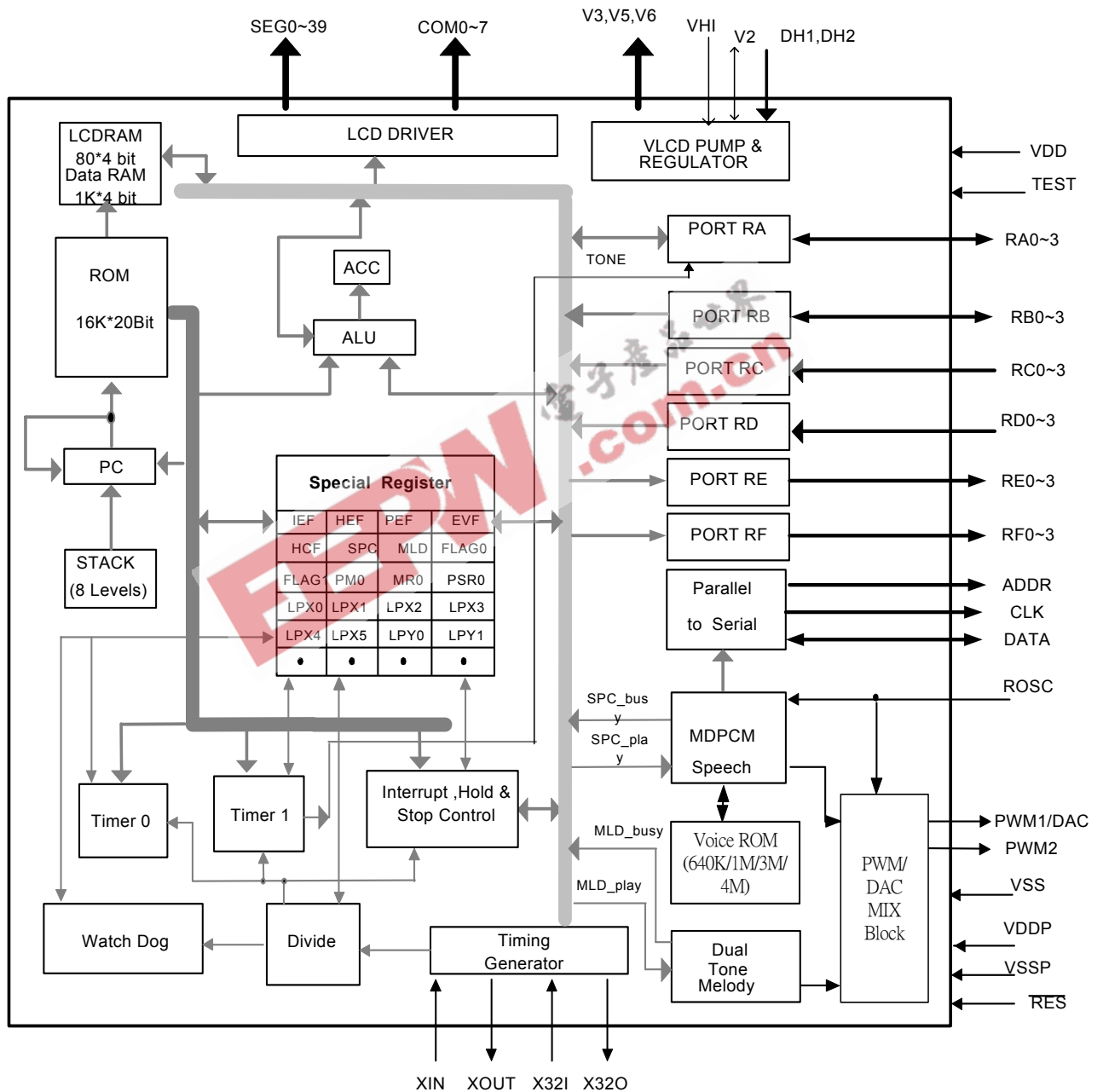

W536020K/030K/060K/090K/120K



4. PAD DESCRIPTION

SYMBOL	I/O	FUNCTION
XIN/RXIN	I	Input pad for main clock oscillator. It can be connected to crystal when crystal mode is selected (SCR0.2 = 1), otherwise connect a resistor to V _{DD} to generate main system clock while Ring mode is selected (SCR0.2 = 0 and default). Oscillator can be enabled or stopped by set SCR0.1 to 1 or clear to 0 separately. External capacitor connects to start oscillation and get more accurate clock when crystal mode
XOUT	O	Output pad for oscillator which is connected to another crystal pad when in crystal mode. External capacitor connects to start oscillation when in crystal mode.
X32I/RSUB1	I	32.768 KHz crystal input pad or external resistor node 1 by mask option . External 15~20pF capacitor connects to start oscillation and get more accurate clock when in crystal mode.
X32O/RSUB2	O	32.768 KHz crystal output pad or external resistor node 2 by mask option . External 15~20pF capacitor connects to start oscillation when in crystal mode.
RA0 ~ RA3/TONE (9)	I/O	General Input/Output port specified by PM1 register. If output mode is selected, PM0 register bit 0 can be used to specify CMOS/NMOS driving capability option. Initial state is input mode. RA3 may be uses as TONE if bit 0 of MR0 special register is set to logic 1. An interrupt source.
RB0 ~ RB3 (9)	I/O	General Input/Output port specified by PM2 register. If output mode is selected, PM0 register bit 1 can be used to specify CMOS/NMOS driving capability option. Initial state is input mode (W536060K/090K/120K only.)
RC0 ~ RC3	I	4-bit schmitter input with internal pull high option specified by PM3 register bit 2. Each pad has an independent interrupt capability specified by PEFL special register. Interrupt and STOP mode wake up source. RC0 is also the external event counter source of Timer1.
RD0 RD1/CLK RD2/DATA RD3/ADDR (4)	I	4-bit schmitter input port with internal pull high option specified by PM3 register bit 3. Each pad has an independent interrupt capability specified by PEFH special register. Interrupt and STOP mode wake up source. RD1~3 will be shared as the external memory W55XXX interface pads while RD port shared as serial bus mask option is enabled @W536020K/030K. For W536020K/030K only, "Tri-state serial bus" mask option can use to float ADDR/CLK/DATD while "RD port shared as serial bus" mask option is enabled.
RE0~RE3 (9)	O	Output port only. PM3 register bit 0 can be used to specify CMOS/NMOS driving capability option. (W536090K/120K only)
RF0~RF3 (9)	O	Output port only. PM3 register bit 1 can be used to specify CMOS/NMOS driving capability option. (W536090K/120K only)

W536020K/030K/060K/090K/120K



PAD Description, continued

SYMBOL	I/O	FUNCTION
$\overline{\text{RES}}$	I	System reset pad, active low with internal pull-high resistor.
TEST	I	Test pad. Active high with internal pull low resistor.
ROSC	I	Connect resistor to V_{DD} pad to generate speech or melody playing clock source.
PWM1/DAC	O	While speech or melody is active, PWM1/DAC is speaker direct driving output or DAC output controlled by voice output file.
PWM2	O	While speech or melody is active, PWM2 is another speaker direct driving output.
ADDR (5)	O	External serial memory address write clock for voice extension (W536120K only).
CLK (5)	O	External serial memory address read clock for voice extension. (W536120K only).
DATA (5)	I/O	External serial memory data in/out for voice extension (W536120K only).
SEG0–SEG15	O	Dedicated LCD segment output pads.
SEG16/PORTN.0 SEG19/PORTN.3	O/O	LCD segment output pads, and can be shared as general output by register LCDM3 bit 1. Default function is segment pad.
SEG20/PORTM.0 SEG23/PORTM.3	O/I	LCD segment output pads, and can be shared as general input by register LCDM3 bit 0. Default function is segment pad and PM5.1=0 to inhibit LCD waveform abnormal.
SEG24/PORTL.0 SEG27/PORTL.3	O/O	LCD segment output pads, and can be shared as general output by register LCDM2 bit 3. Default function is segment pad.
SEG28/PORTK.0 SEG31/PORTK.3	O/I	LCD segment output pads, and can be shared as general input by register LCDM2 bit 2. Default function is segment pad and PM5.0=0 to inhibit LCD waveform abnormal.
SEG32/PORTJ.0 SEG35/PORTJ.3	O/I/O	LCD segment output pads, and can be shared as general input/output by register LCDM2 bit 1. PM4 register is used to select input or output while shared I/O function is active. Default function is segment pad and PM4.3 = 0 to inhibit LCD waveform abnormal.
SEG36/PORTI.0 SEG39/PORTI.3	O/I/O	LCD segment output pads, and can be shared as general input/output by register LCDM2 bit 0. PM4 register is used to select input or output while shared I/O function is active. Default function is segment pad and PM4.2 = 0 to inhibit LCD waveform abnormal.

W536020K/030K/060K/090K/120K



PAD Description, continued

SYMBOL	I/O	FUNCTION
COM0–COM3	O	LCD common signal output pads either 1/8 duty or 1/4duty. The LCD frame rate is controlled by LCDM1 register, and default value LCDM1 = 0111b with 64Hz frame rate.
COM4/PORTO.0 COM7/PORTO.3	O/I	LCD common signal output pads, or shared as general input by register LCDM3.2 when in 1/4 duty mode. Default function is common function and PM5.2 = 0 to inhibit LCD waveform abnormal.
DH1, DH2 (6)	O	Connection terminal for voltage double capacitor with 0.1uF. The DH2 connects to capacitor positive node and DH1 negative node if polar capacitor is used.
VHI	I	Connect to V6 (LCD's VLCD) or V _{DD} which has higher voltage, to make sure there is no any abnormal leakage current appearance.
V3	O	LCD COM/SEG output driving voltage. Need an external 0.1uF capacitor when 1/4 bias. (LCDM0.1 = 1)
V5 V6 (6)	O	LCD COM/SEG output driving voltage. Need an external 0.1uF capacitor to every pad terminal.
V2 (6)	I/O	Voltage regulator output pad. An external capacitor is a must. Output level can be controlled from 0~Fh by LCDM4 register. If internal pump is enabled (LCDM3.3 = 0 and default value), LCD operating voltage (VLCD) will be 3*V2 or 4*V2 depending on 1/3 bias or 1/4 bias. A limitation should be noted that VLCD must be higher than (V _{DD} -0.5v) to avoid chip leakage current. While external reference voltage is selected (LCDM3.3 = 1), V2 pad input voltage can not be over 1.5 Volt to inhibit chip damage.
V _{SSP} (7)	I	Power ground for PWM or DAC playing output.
V _{SS} (7)	I	Power ground
V _{DDP} (7)	I	Power source for PWM or DAC playing output.
V _{DD} (7)	I	Power Source

Notes:

- (4) RD1~3 are shared as CLK/DATA/ADDR to interface with W55XXX @W536020K/030K.
- (5) @W536120K only
- (6) 0.1uF is default value, and capacitor value should be larger than 0.1uF if LCD dot size over 0.5mm * 0.5mm.
- (7) External application circuit should connect together, please refer to APPLICATION CIRCUIT. To sure chip operation properly, please bond all V_{DD}, V_{DDP}, V_{SS} and V_{SSP} pads and connect V_{SS} and V_{SSP} from chip outside PCB circuit.
- (8) VHI pad is bonded to V6 or V_{DD}.
- (9) When working at NMOS open drain mode, external pull high voltage can't bigger than V_{DD} to avoid leakage current.

W536020K/030K/060K/090K/120K



5. ELECTRICAL CHARACTERISTICS

5.1 Absolute Maximum Ratings

PARAMETER	RATING	UNIT
Supply Voltage to Ground Potential	-0.3 to +7.0	V
Applied Input/Output Voltage	-0.3 to +7.0	V
Power Dissipation	120	mW
Ambient Operating Temperature	0 to +70	°C
Storage Temperature	-55 to +150	°C

Note: Exposure to conditions beyond those listed under Absolute Maximum Ratings may adversely affect the life and reliability of the device.

5.2 DC Characteristics

($V_{DD}-V_{SS} = 3.0V$, no load, FM = 4 MHz with Ring mode, $F_s = 32.768$ KHz, with Xtal mode, $T_A = 25^\circ C$, STN LCD panel on with dot size 0.5mm*0.5mm; unless otherwise specified)

PARAMETER	SYM.	CONDITIONS	MIN.	TYP.	MAX.	UNIT
Op. Voltage	V _{DD}		2.4		5.5	V
Op. Current (No Load, no Voice, no Melody)	IOP1	Dual clock with crystal	-	600	700	μA
		Dual clock with Ring type		600	700	
		Sub-clock only, LCD off		40	50	
		Sub-clock only, LCD on		70	90	
Hold Mode Current (No Load, LCD OFF)	IOP2	Sub-clock active only		3	5	μA
Hold Mode Current (No load, LCD ON)	IOP3	Sub-clock active only			35	uA
Stop Mode Current	IOP4	LCD auto off			1	μA
CLK/ADDR Output High Current	I _{OH1}	V _{out} = 2.7V			-0.8	mA
CLK/ADDR Output low Current	I _{OL1}	V _{out} = 0.4V			0.8	mA
Input Low Voltage	V _{IL}	-	V _{SS}	-	0.3	V _{DD}
Input High Voltage	V _{IH}	-	0.7	-	1	V _{DD}
Port RA, RB, RE, RF Output Low Voltage	V _{ABL}	I _{OL} = 2.0 mA	-	-	0.4	V
Port RA, RB, RE, RF Output High Voltage	V _{ABH}	I _{OH} = -2.0 mA	2.4	-	-	V

W536020K/030K/060K/090K/120K



DC Characteristics, continued

PARAMETER	SYM.	CONDITIONS	MIN.	TYP.	MAX.	UNIT
Pull-up Resistor	RCD	Port RC, RD	200	300	400	K Ω
Share Output RI, RJ, RL, RN, RP Sink Current	IOL3	VOL= 0.4V	-300			μ A
RES Pull-up Resistor	RRES	-	50	100	200	K Ω
PWM1/2 Source Current (8) (R _{LOAD} =8 Ω between PWM1 And PWM2)	ISPH	Volume Option = 00		-20		mA
		Volume Option = 01		-70		
		Volume Option = 10		-110		
		Volume Option = 11		-135		
PWM1/2 Sink Current (8) (R _{LOAD} = 8 Ω between PWM1 And PWM2)	ISPL	Volume Option = 00		20		mA
		Volume Option = 01		70		
		Volume Option = 10		110		
		Volume Option = 11		135		
DAC output Current	IDAC	V _{DD} = 3V, RL = 100ohm	-4	-5	-6	mA
LCD Supply Current	ILCD	No Load, All Seg. ON	-	50	-	μ A
COM/SEG On Resistor	RON	I _{OH} = \pm 50 μ A		5K	10K	Ω
V2 Pad Output Voltage	V _{RR}	Depended on LCDM4	0.7		1.45	V
V2 Pad Output Deviation (9)	V _{D1}	No Load			\pm 5	%
V2 Pad Voltage Step	V _{R2}	LCDM4 increased 1		50		mV
V6 Pad Output Voltage (LCD's VLCD depended on LCDM4 register) (9)	VLCD	1/3 Bias & no load	2.85 * V2	2.9 * V2	2.95 * V2	V
		1/4 Bias & no load	3.8 * V2	3.85 * V2	3.9 * V2	
V2 input voltage	VEXT	LCDM3.3 = 1			1.5	V

Notes:

- (8) PWM current deviation will be \pm 20%.
- (9) Deviation is governed by LCD dot size. More larger LCD dot will get larger deviation..

W536020K/030K/060K/090K/120K



5.3 AC Characteristics

($V_{DD}-V_{SS} = 3.0V$, no load, FM = 4 MHz with Ring mode, Fs = 32.768 KHz, with Xtal mode, $T_A = 25^\circ C$, STN LCD on with dot size 0.5mm*0.5mm; unless otherwise specified)

PARAMETER	SYM.	CONDITIONS	MIN.	TYP.	MAX.	UNIT
Sub-clock Frequency	FSUB	Crystal type and X32IN and X32O with 17pF external cap.		32768		Hz
Main-clock Frequency	FM	Ring type/Crystal type	400K	-	4M	Hz
Chip Operation Frequency	FOSC	SCR0.0 = 1, FSYS = FSUB		32768		Hz
		SCR0.0 = 0; FSYS = FMAIN	400K	-	4M	
Instruction Cycle Time	TCYC	One machine cycle	-	4/FOSC	-	S
Reset Active Width	TRAW	FOSC = 32.768 KHz	1	-	-	μS
Interrupt Active Width	TIAW	FOSC = 32.768 KHz	1	-	-	μS
Main clock Ring frequency (10)	FRXIN	RXIN = 680K Ω		1M		Hz
		RXIN = 330K Ω		2M		
		RXIN = 200K Ω		3M		
		RXIN = 130K Ω		4M		
Sub-Clock RC Oscillator	FRSUB	RSUB = 680K Ω		32		KHz
Sub-Clock Oscillation Stable Time @ Cold Start	FSTOP	RSUB = 680K Ω	0.8		1	S
Frequency Deviation of main-clock FRXIN ≤ 2 MHz	$\frac{\Delta f}{f}$	$\frac{f(3V) - f(2.4V)}{f(3V)}$			10	%
Frequency Deviation of main-clock FRXIN = 3 MHz	$\frac{\Delta f}{f}$	$\frac{f(3V) - f(2.4V)}{f(3V)}$			15	%
Frequency Deviation of main-clock FRXIN = 4 MHz	$\frac{\Delta f}{f}$	$\frac{f(3V) - f(2.4V)}{f(3V)}$			20	%
ROSC Frequency	FROSC	ROSC=680K Ω		3		MHz
Frequency Deviation of FROSC = 3MHz	$\frac{\Delta f}{f}$	$\frac{f(3V) - f(2.4V)}{f(3V)}$			7.5	%
Frame frequency	FLCD	LCDM1 = 0111 b(default)		64		Hz

Notes:

(10) The deviation will be +20% while V_{DD} drops from 5.5V to 2.4V based on same resistor

W536020K/030K/060K/090K/120K

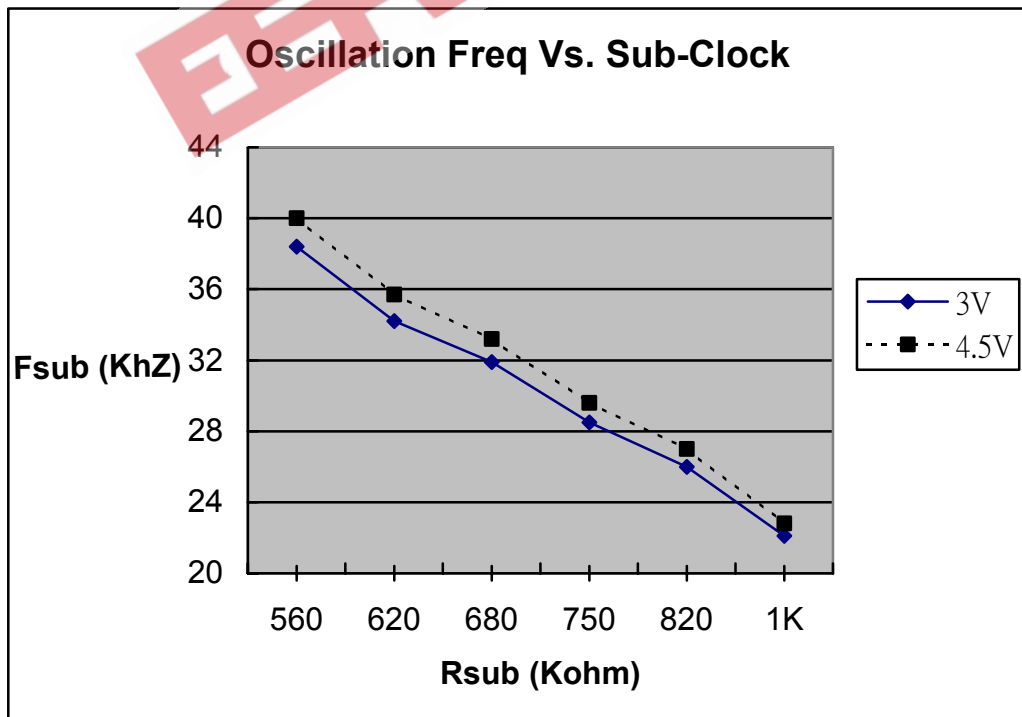
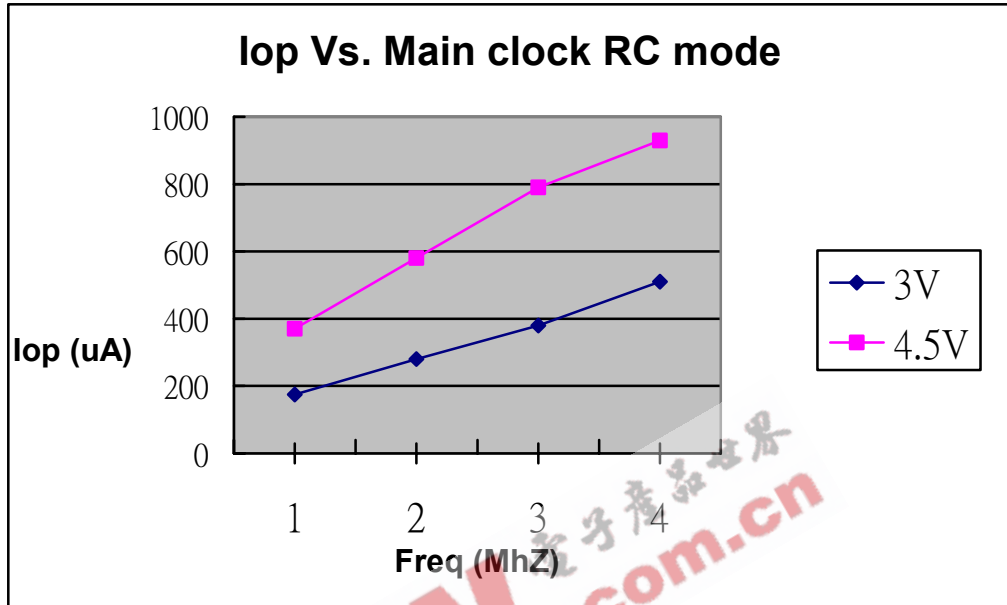

W536020K/030K/060K/090K/120K

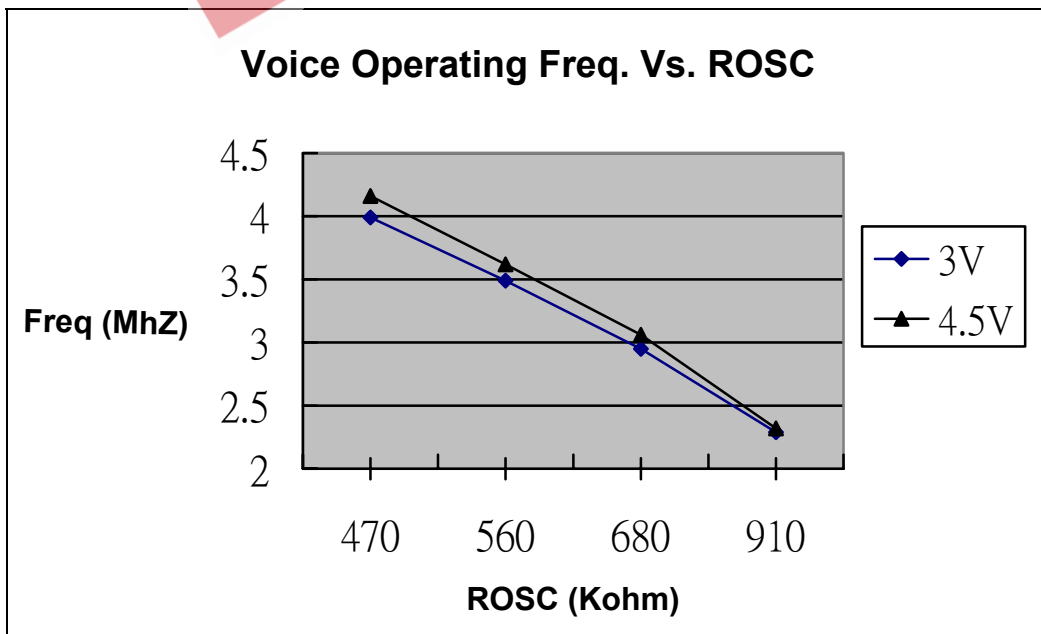
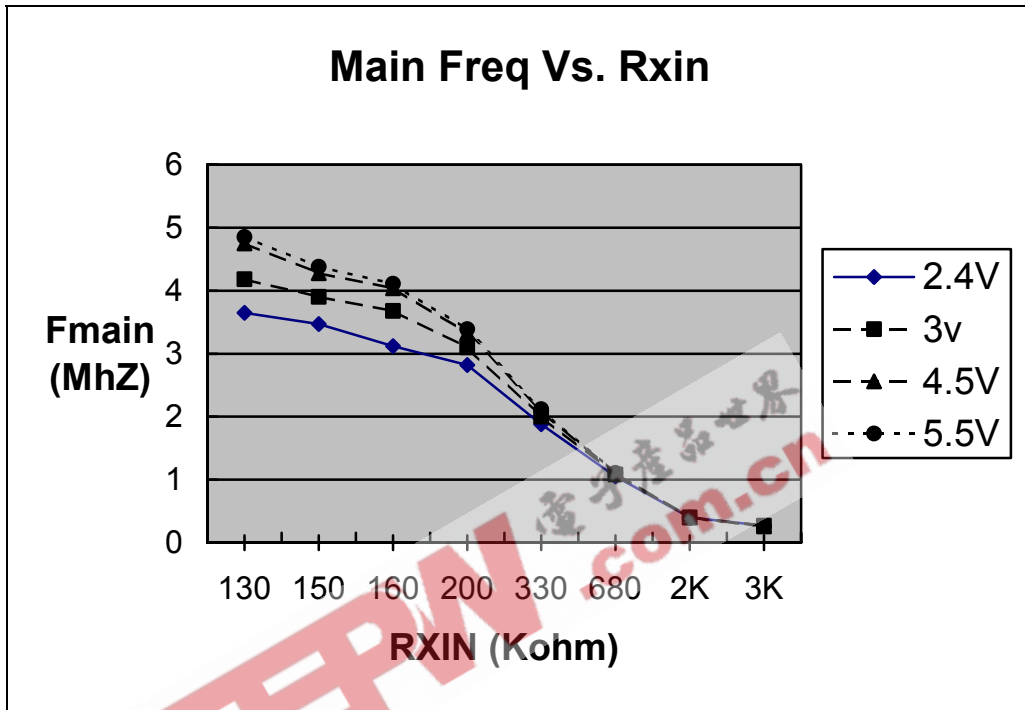

W536020K/030K/060K/090K/120K



6. TYPICAL APPLICATION CIRCUITS

6.1 Sub Clock with RC Mode

1/4 bias, $V_{LCD} = 4.5V$, $V_{DD} = 2.4\sim 3.6V$

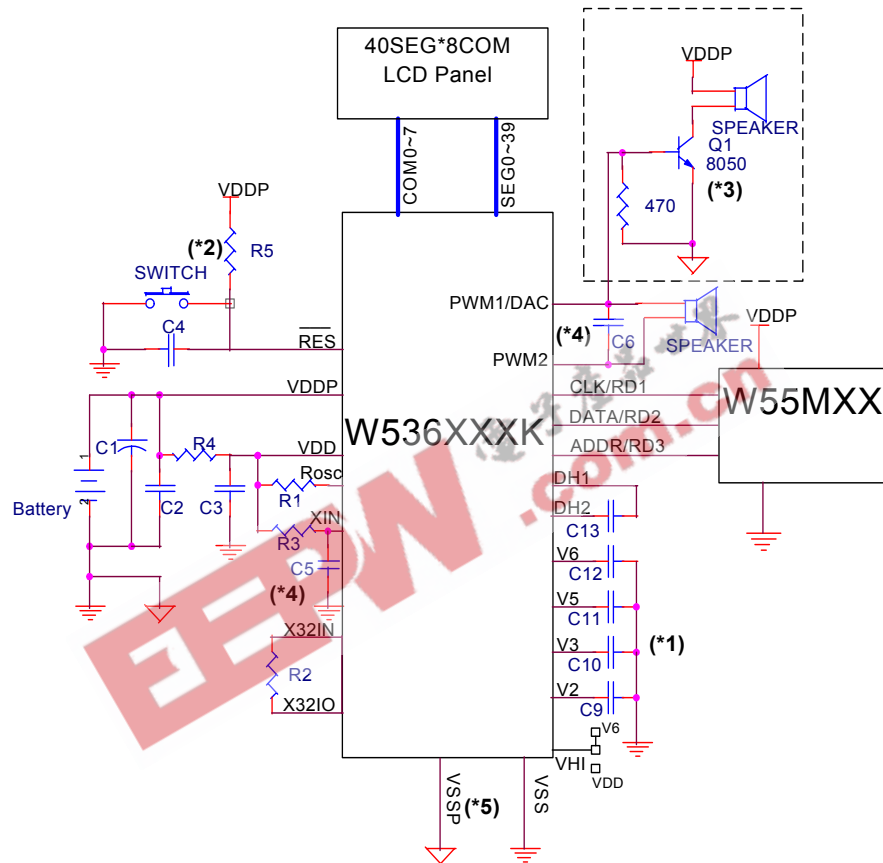

COMPONENT	C1	C2~C4	C5~C6	C7~C8	C9~C13	R1	R2	R3	R4
Value $V_{DD} = 3V$	4.7uF	0.1uF	100pF	-	0.1~1uF	680KΩ	655KΩ	680KΩ/1MHz 350KΩ/2MHz 215KΩ/3MHz 150KΩ/4MHz	100Ω
Value $V_{DD} = 4.5V$	4.7uF	0.1uF	100pF	-	0.1~1uF	680KΩ	675KΩ	750KΩ/1MHz 350KΩ/2MHz 225KΩ/3MHz 160KΩ/4MHz	100Ω

Notes:

- C9~C13 depends on LCD panel dot size.
- Option R5 equals to 100Ω if high noise immunity is needed.
- For DAC option application.
- To ensure that three batteries function well in W536F20 demo board. C₆ should stay close to pad PWM/PWM2 at its best. Under the mask ROM version, C₅ and C₆ can be skipped.
- Sure chip operation properly, please bond all V_{DDP}, V_{DD}, V_{SSP} and V_{SS}; and connect V_{SSP} pad to V_{SS} from external PCB circuit.

W536020K/030K/060K/090K/120K



6.2 Sub Clock with Crystal Mode

1/3 bias, $V_{LCD} = 3V$, $V_{DD} = 3.6\sim 5.4V$

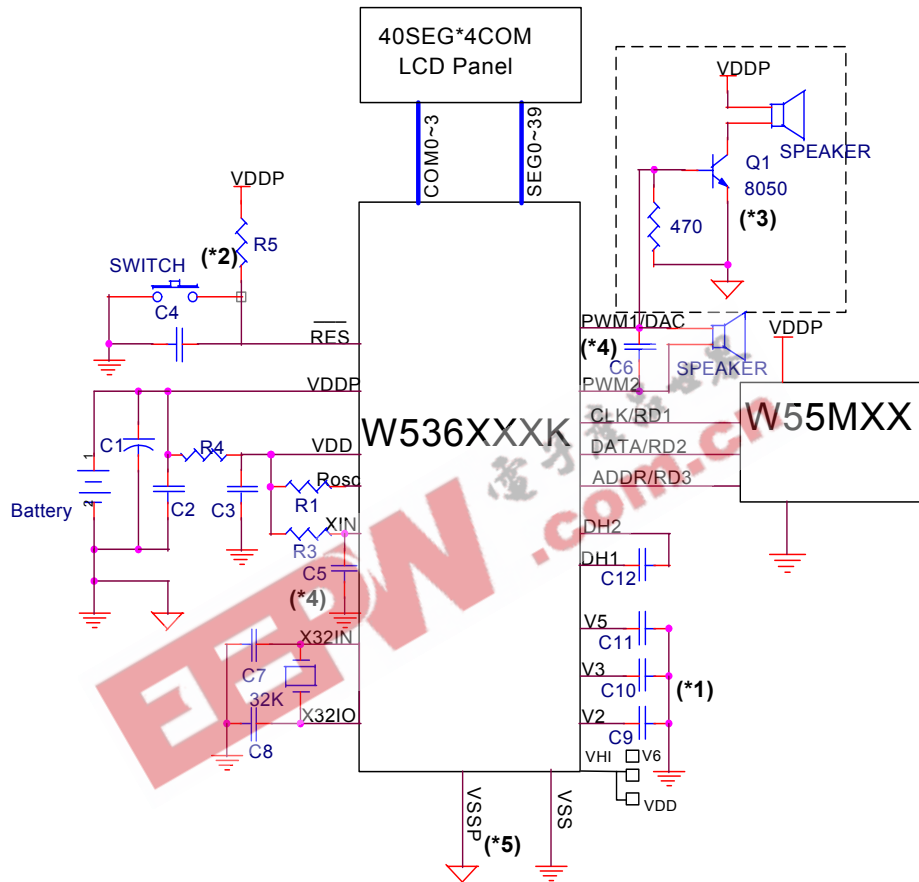

Component	C1	C2~C4	C5~C6	C7~C8	C9~C12	R1	R2	R3	R4
Value $V_{DD} = 3V$	4.7uF	0.1uF	100pF	15~30PF	0.1~1uF	680KΩ	-	680KΩ/1MHz 350KΩ/2MHz 215KΩ/3MHz 150KΩ/4MHz	100Ω
Value $V_{DD} = 4.5V$	4.7uF	0.1uF	100pF	15~30PF	0.1~1uF	680KΩ	-	750KΩ/1MHz 350KΩ/2MHz 225KΩ/3MHz 160KΩ/4MHz	100Ω

Notes:

- C9~C12 depends on LCD panel dot size.
- Option R5 equals to 100Ω if high noise immunity is needed.
- For DAC option application.
- To ensure that three batteries function well in W536F20 demo board. C₆ should stay close to 5. pad PWM/PWM2 at its best. Under the mask ROM version, C₅ and C₆ can be skipped.
- Sure chip operation properly, please bond all V_{DDP}, V_{DD}, V_{SSP} and V_{SS}; and connect V_{SSP} pad to V_{SS} from external PCB circuit.

W536020K/030K/060K/090K/120K



7. REVISION HISTORY

VERSION	DATE	WRITER	DESCRIPTION
A1	SEP. 18, 2000	Jimmy Chen	
A2	NOV. 24, 2000	Jimmy Chen	● Application circuit modify
A3	May 21, 2003	Jimmy Chen	● Application circuit modify



Headquarters
No. 4, Creation Rd. III,
Science-Based Industrial Park,
Hsinchu, Taiwan
TEL: 886-3-5770066
FAX: 886-3-5665577
<http://www.winbond.com.tw/>

Taipei Office
9F, No.480, Rueiguang Rd.,
Neihu District, Taipei, 114,
Taiwan, R.O.C.
TEL: 886-2-8177-7168
FAX: 886-2-8751-3579

Winbond Electronics Corporation America
2727 North First Street, San Jose,
CA 95134, U.S.A.
TEL: 1-408-9436666
FAX: 1-408-5441798

Winbond Electronics Corporation Japan
7F Daini-ueno BLDG, 3-7-18
Shinyokohama Kohoku-ku,
Yokohama, 222-0033
TEL: 81-45-4781881
FAX: 81-45-4781800

Winbond Electronics (Shanghai) Ltd.
27F, 2299 Yan An W. Rd. Shanghai,
200336 China
TEL: 86-21-62365999
FAX: 86-21-62365998

Winbond Electronics (H.K.) Ltd.
Unit 9-15, 22F, Millennium City,
No. 378 Kwun Tong Rd.,
Kowloon, Hong Kong
TEL: 852-27513100
FAX: 852-27552064

*Please note that all data and specifications are subject to change without notice.
All the trade marks of products and companies mentioned in this data sheet belong to their respective owners.*

Information contained in this publication regarding device applications and the like is intended for suggestion only and may be superseded updates. No representation or warranty is given and no liability is assumed by Winbond Electronics Corp. with respect to the accuracy or use of such information, or infringement of patents or other intellectual property.