

## 16MB (4x512Kx72) SYNC / SYNC BURST, DUAL KEY DIMM SRAM MODULE

### FEATURES

- 4x512Kx72 Synchronous, Synchronous Burst
- Flow-Through Architecture
- Linear and Sequential Burst Support via MODE pin
- Clock Controlled Registered Module Enable (EM#)
- Clock Controlled Registered Bank Enables (E1#, E2#, E3#, E4#)
- Clock Controlled Byte Write Mode Enable (BWE#)
- Clock Controlled Byte Write Enables (BW1# - BW8#)
- Clock Controlled Registered Address
- Clock Controlled Registered Global Write (GW#)
- Asynchronous Output Enable (G#)
- Internally Self-Timed Write
- Individual Bank Sleep Mode Enables (ZZ1, ZZ2, ZZ3, ZZ4)
- Gold Lead Finish
- 3.3V ± 10% Operation
- Frequency(s): 100, 83, 67, 50MHz
- Access Speed(s): tKHQV = 7.5, 9, 10, 12, 15ns
- Common Data I/O
- High Capacitance (30pF) Drive, at Rated Access Speed
- Single Total Array Clock

### DESCRIPTION

The WED2CG472512V is a Synchronous/Synchronous Burst SRAM, 84 position Dual Key; Double High DIMM (168 contacts) Module, organized as 4x512Kx72. The Module contains sixteen (16) Synchronous Burst RAM devices, packaged in the industry standard JEDEC 14mmx20mm TQFP placed on a Multilayer FR4 Substrate. The Module Architecture is defined as a Sync/SyncBurst, Flow-Through, with support for either linear or sequential burst. This Module provides high performance, 2-1-1-1 accesses when used in Burst Mode, and when used in Synchronous Only Mode, provides a high performance cost advantage over BiCMOS asynchronous device architectures.

Synchronous Only operations are performed via strapping ADSC# Low, and ADSP#/ADV# High, which provides for Ultra Fast Accesses in Read Mode while providing for internally self-timed Early Writes.

Synchronous/Synchronous Burst operations are in relation to an externally supplied clock, Registered Address, Registered Global Write, Registered Enables as well as an Asynchronous Output Enable. This Module has been defined with full flexibility, which allows individual control of each of the eight bytes, as well as Quad Words in both Read and Write Operations.

\* This product is under development, is not qualified or characterized and is subject to change or cancellation without notice.

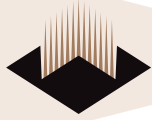

**FIG. 1 PIN CONFIGURATION**

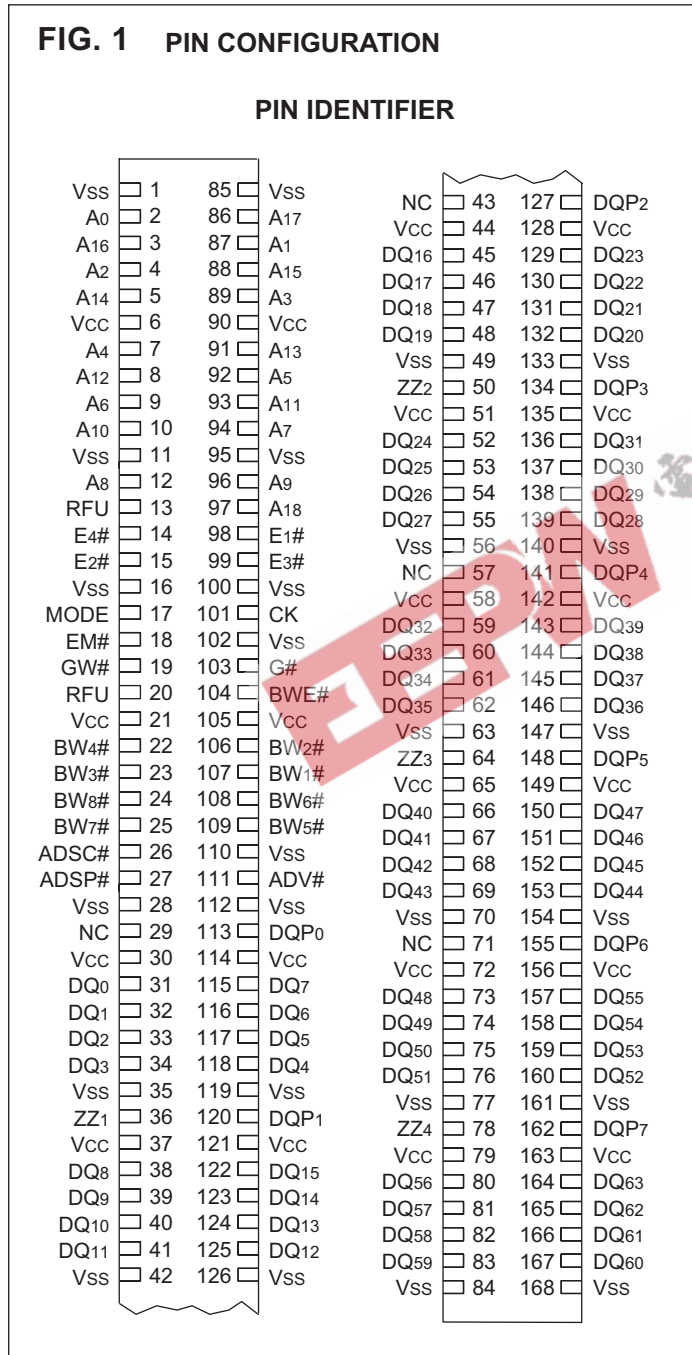

**PIN DESCRIPTION**

DQ0 - DQ63	Input/Output Bus
DQP0 - DQP7	Parity Bits
A0 - A18	Address Bus
EM#	Module Enable
E1#, E2#, E3#, E4#	Synchronous Bank Enables
BWE#	Byte Write Mode Enable
BW1# - BW8#	Byte Write Enables
CK	Array Clock
GW#	Synchronous Global Write Enable
G#	Asynchronous Output Enable
ZZ1, ZZ2, ZZ3, ZZ4	Bank Sleep Mode Enables
VCC	3.3V Power Supply
VSS	Gnd



**FIG. 2**

**FUNCTIONAL BLOCK DIAGRAM**

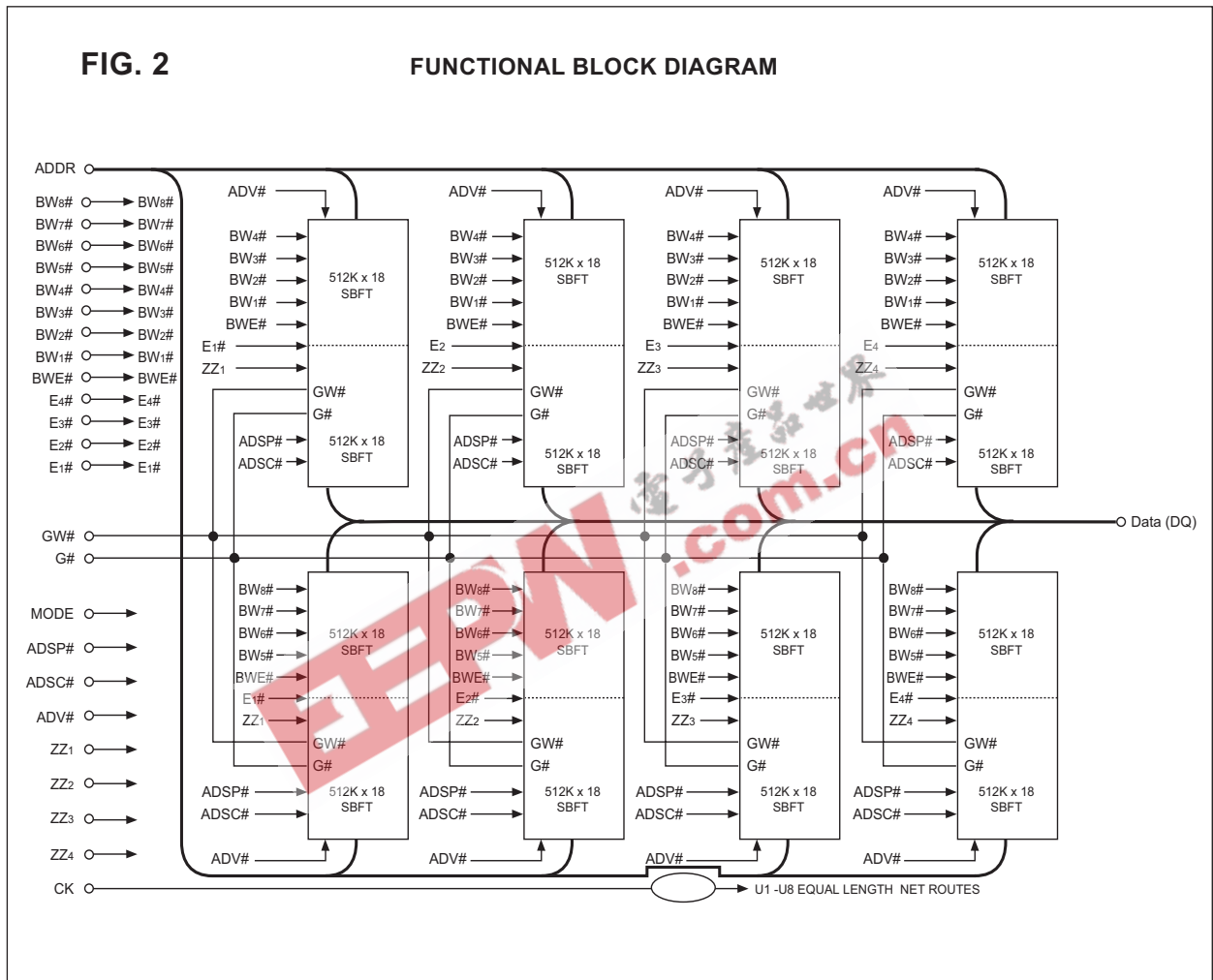

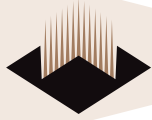

**SYNC BURST – TRUTH TABLE**

Operation	E1#	E2#	E3#	E4#	ADSP#	ADSC#	ADV#	GW#	G#	CK	DQ	Addr. Used
Deselected Cycle, Power Down; Bank 1	H	X	*	*	X	L	X	X	X	L-H	High-Z	None
Deselected Cycle, Power Down; Bank 2	X	H	*	*	X	L	X	X	X	L-H	High-Z	None
Read Cycle, Begin Burst; Bank 1	L	H	*	*	L	X	X	X	L	L-H	Q	External
Read Cycle, Begin Burst; Bank 1	L	H	*	*	L	X	X	X	H	L-H	High-Z	External
Read Cycle, Begin Burst; Bank 2	H	L	*	*	L	X	X	X	L	L-H	Q	External
Read Cycle, Begin Burst; Bank 2	H	L	*	*	L	X	X	X	H	L-H	High-Z	External
Write Cycle, Begin Burst; Bank 1	L	H	*	*	H	L	X	L	X	L-H	D	External
Write Cycle, Begin Burst; Bank 2	H	L	*	*	H	L	X	L	X	L-H	D	External
Read Cycle, Begin Burst; Bank 1	L	H	*	*	H	L	X	H	L	L-H	Q	External
Read Cycle, Begin Burst; Bank 1	L	H	*	*	H	L	X	H	H	L-H	High-Z	External
Read Cycle, Begin Burst; Bank 2	H	L	*	*	H	L	X	H	L	L-H	Q	External
Read Cycle, Begin Burst; Bank 2	H	L	*	*	H	L	X	H	H	L-H	High-Z	External
Read Cycle, Continue Burst; Bank 1	X	H	*	*	X	H	L	H	L	L-H	Q	Next
Read Cycle, Continue Burst; Bank 1	X	H	*	*	X	H	L	H	H	L-H	High-Z	Next
Read Cycle, Continue Burst; Bank 2	H	X	*	*	X	H	L	H	L	L-H	Q	Next
Read Cycle, Continue Burst; Bank 2	H	X	*	*	X	H	L	H	H	L-H	High-Z	Next
Read Cycle, Continue Burst; Bank 1	H	H	*	*	X	H	L	H	L	L-H	Q	Next
Read Cycle, Continue Burst; Bank 1	H	H	*	*	X	H	L	H	H	L-H	High-Z	Next
Read Cycle, Continue Burst; Bank 2	H	H	*	*	X	H	L	H	L	L-H	Q	Next
Read Cycle, Continue Burst; Bank 2	H	H	*	*	X	H	L	H	H	L-H	High-Z	Next
Write Cycle, Continue Burst; Bank 1	X	H	*	*	H	H	L	L	X	L-H	D	Next
Write Cycle, Continue Burst; Bank 1	H	H	*	*	X	H	L	L	X	L-H	D	Next
Write Cycle, Continue Burst; Bank 2	H	X	*	*	H	H	L	L	X	L-H	D	Next
Write Cycle, Continue Burst; Bank 2	H	H	*	*	X	H	L	L	X	L-H	D	Next
Read Cycle, Suspend Burst; Bank 1	X	H	*	*	H	H	H	H	L	L-H	Q	Current
Read Cycle, Suspend Burst; Bank 1	X	H	*	*	H	H	H	H	H	L-H	High-Z	Current
Read Cycle, Suspend Burst; Bank 2	H	X	*	*	H	H	H	H	L	L-H	Q	Current
Read Cycle, Suspend Burst; Bank 2	H	X	*	*	H	H	H	H	H	L-H	High-Z	Current
Read Cycle, Suspend Burst; Bank 1	H	H	*	*	X	H	H	H	L	L-H	Q	Current
Read Cycle, Suspend Burst; Bank 1	H	H	*	*	X	H	H	H	H	L-H	High-Z	Current
Read Cycle, Suspend Burst; Bank 2	H	H	*	*	X	H	H	H	L	L-H	Q	Current
Read Cycle, Suspend Burst; Bank 2	H	H	*	*	X	H	H	H	H	L-H	High-Z	Current
Write Cycle, Suspend Burst; Bank 1	X	H	*	*	H	H	H	L	X	L-H	D	Current
Write Cycle, Suspend Burst; Bank 1	H	H	*	*	X	H	H	L	X	L-H	D	Current
Write Cycle, Suspend Burst; Bank 2	H	X	*	*	H	H	H	L	X	L-H	D	Current
Write Cycle, Suspend Burst; Bank 2	H	H	*	*	X	H	H	L	X	L-H	D	Current

Note A: All truth Table Functions Repeat for Bank 3 (E3#) and Bank 4 (E4#).

**SYNCHRONOUS ONLY – TRUTH TABLE**

Operation	E1#	E2#	E3#	E4#	GW#	G#	ZZ	CK	DQ
Synchronous Write - Bank 1	L	H	H	H	L	H	L	↑	High-Z
Synchronous Read - Bank 1	L	H	H	H	H	L	L	↑	
Synchronous Write - Bank 2	H	L	H	H	L	H	L	↑	High-Z
Synchronous Read - Bank 2	H	L	H	H	H	L	L	↑	
Synchronous Write - Bank 3	H	H	L	H	L	H	L	↑	High-Z
Synchronous Read - Bank 3	H	H	L	H	H	L	L	↑	
Synchronous Write - Bank 4	H	H	H	L	L	H	L	↑	High-Z
Synchronous Read - Bank 4	H	H	H	L	H	L	L	↑	
Snooze Mode	X	X	X	X	X	X	H	X	High-Z

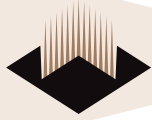

**ABSOLUTE MAXIMUM RATINGS\***

Voltage on V <sub>CC</sub> Relative to V <sub>SS</sub>	-0.3V to +4.6V
V <sub>IN</sub>	-0.3V to V <sub>CC</sub> +0.5V
Storage Temperature	-55°C to + 125°C
Operating Temperature (Commercial)	0°C to +70°C
Operating Temperature (Industrial)	-40°C to +85°C
Short Circuit Output Current	100mA

**RECOMMENDED DC OPERATING CONDITIONS**

Parameter	Sym	Min	Typ	Max	Units
Supply Voltage	V <sub>CC</sub>	3.3	3.3	3.6	V
Supply Voltage	V <sub>SS</sub>	0	0	0	V
Input High	V <sub>IH</sub>	2.0	3.0	V <sub>CC</sub> +0.3	V
Input Low	V <sub>IL</sub>	-0.3	0	0.3	V
Input Leakage	I <sub>LI</sub>	-2	1	2	mA
Output Leakage	I <sub>LO</sub>	-2	1	2	mA

\*Stress greater than those listed under "Absolute Maximum Ratings" may cause permanent damage to the device. This is a stress rating only and functional operation of the device at these or any other conditions greater than those indicated in the operational sections of this specification is not implied. Exposure to absolute maximum rating conditions for extended periods may affect reliability.

**DC ELECTRICAL CHARACTERISTICS READ CYCLE**

Description	Sym	Typ	Max				Units
			8.5	10	12	15	
Power Supply Current	I <sub>CC1</sub>	2.0	2.9	2.7	2.7	2.5	A
Power Supply Current Device Selected, No Operation	I <sub>CC</sub>	875	1.8	1.8	1.3	1.3	A
Snooze Mode	I <sub>CCZZ</sub>	270	350	350	350	350	mA
CMOS Standby	I <sub>CC3</sub>	500	700	700	700	700	mA
Clock Running-Deselect	I <sub>CCK</sub>	900	1.1	1.1	1.0	1.0	A

**AC TEST LOAD**

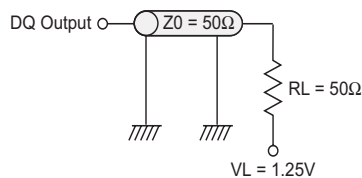

**OUTPUT TEST EQUIVALENCIES**

**AC TEST CONDITIONS**

Input Pulse Levels	V <sub>SS</sub> to 3.0V
Input and Output Timing Ref.	1.25V
Output Test Equivalencies	See figure at left

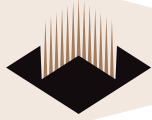

**READ CYCLE TIMING PARAMETERS**

Description	Sym	9ns		10ns		12ns		15ns		Units
		Min	Max	Min	Max	Min	Max	Min	Max	
Frequency	f <sub>MAX</sub>		100		83		67		50	MHz
Clock Cycle Time	t <sub>KHKH</sub>	10		12		15		20		ns
Clock High Time	t <sub>KHKL</sub>	4		5		5		6		ns
Clock Low Time	t <sub>KLKH</sub>	4		5		5		6		ns
Clock to Output Valid	t <sub>KHQV</sub>		9		10		12		15	ns
Clock to Output Invalid	t <sub>KHQX1</sub>	3		3		3		3		ns
Clock to Output Low-Z	t <sub>KHOX</sub>	4		4		4		4		ns
Output Enable to Output Valid	t <sub>GLQV</sub>		4		5		5		5	ns
Output Enable to Output Low-Z	t <sub>GLQX</sub>	0		0		0		0		ns
Output Enable to Output High-Z	t <sub>GHQZ</sub>		4		5		5		5	ns
Address Setup	t <sub>AVKH</sub>	2.5		2.5		2.5		2.5		ns
Bank Enable Setup	t <sub>EVKH</sub>	2.5		2.5		2.5		2.5		ns
Address Hold	t <sub>KHAX</sub>	1.0		1.0		1.0		1.0		ns
Bank Enable Hold	t <sub>KHEX</sub>	1.0		1.0		1.0		1.0		ns

**WRITE CYCLE TIMING PARAMETERS**

Description	Sym	9ns		10ns		12ns		15ns		Units
		Min	Max	Min	Max	Min	Max	Min	Max	
Frequency	f <sub>MAX</sub>		100		83		67		50	MHz
Clock Cycle Time	t <sub>KHKH</sub>	12		12		15		20		ns
Clock High Time	t <sub>KHKL</sub>	4		5		5		6		ns
Clock Low Time	t <sub>KLKH</sub>	4		5		5		6		ns
Address Setup	t <sub>AVKH</sub>	2.5		2.5		2.5		2.5		ns
Address Hold	t <sub>KHAX</sub>	1.0		1.0		1.0		1.0		ns
Bank Enable Setup	t <sub>EVKH</sub>	2.5		2.5		2.5		2.5		ns
Bank Enable Hold	t <sub>KHEX</sub>	1.0		1.0		1.0		1.0		ns
Global Write Enable Setup	t <sub>WVKH</sub>	2.5		2.5		2.5		2.5		ns
Global Write Enable Hold	t <sub>KHWX</sub>	1.0		1.0		1.0		1.0		ns
Data Setup	t <sub>DVKH</sub>	2.5		2.5		2.5		2.5		ns
Data Hold	t <sub>KHDX</sub>	1.0		1.0		1.0		1.0		ns

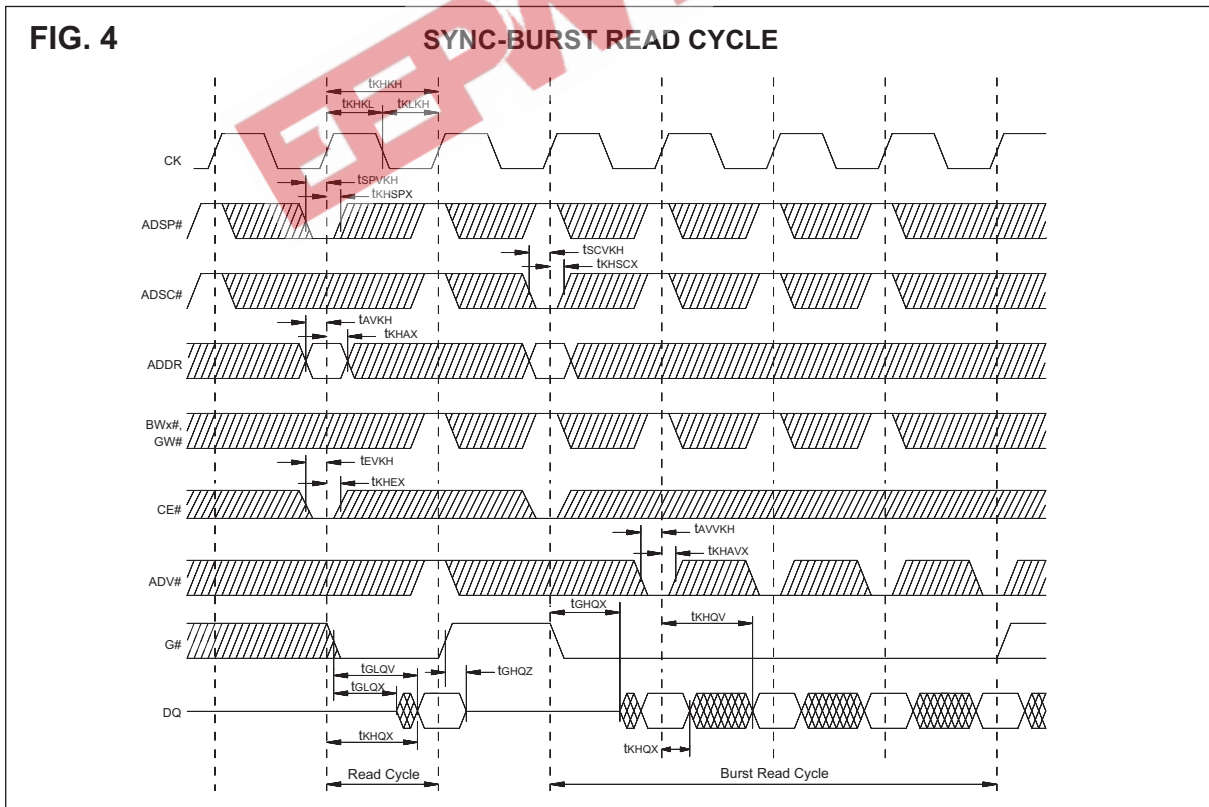
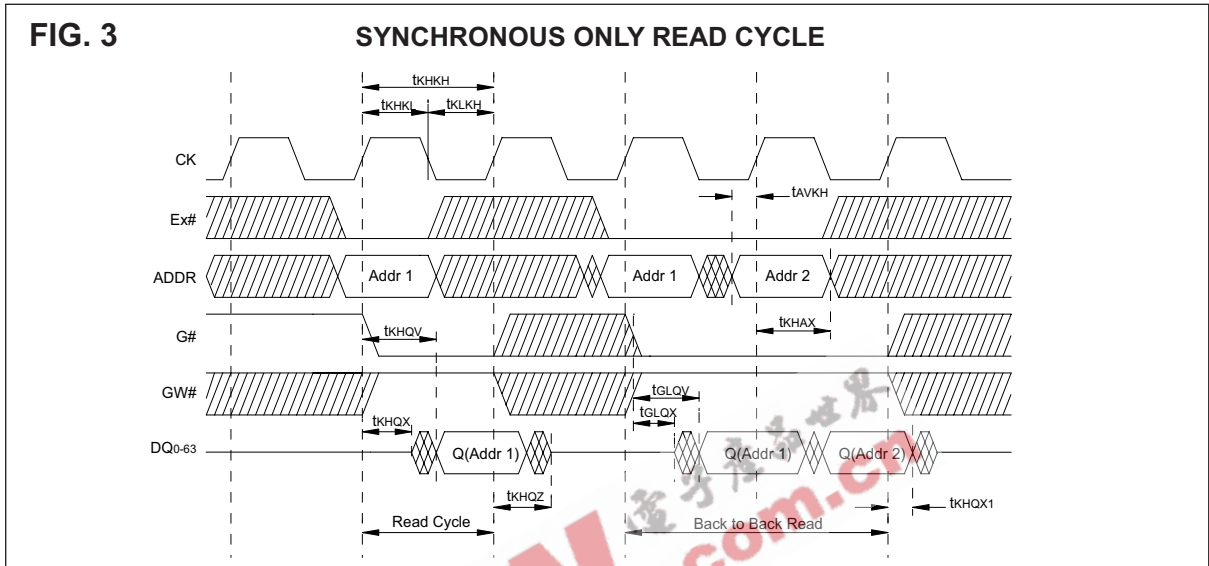
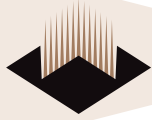

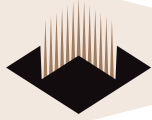

**FIG. 5**

**SYNC (NON-BURST) WRITE CYCLE**

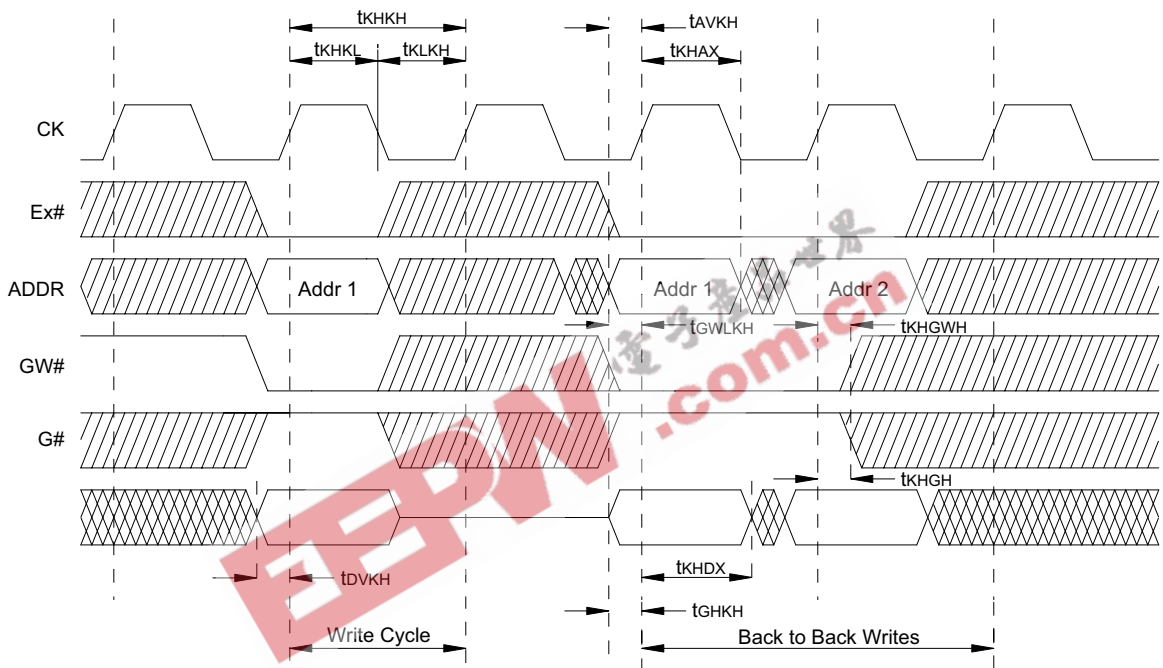
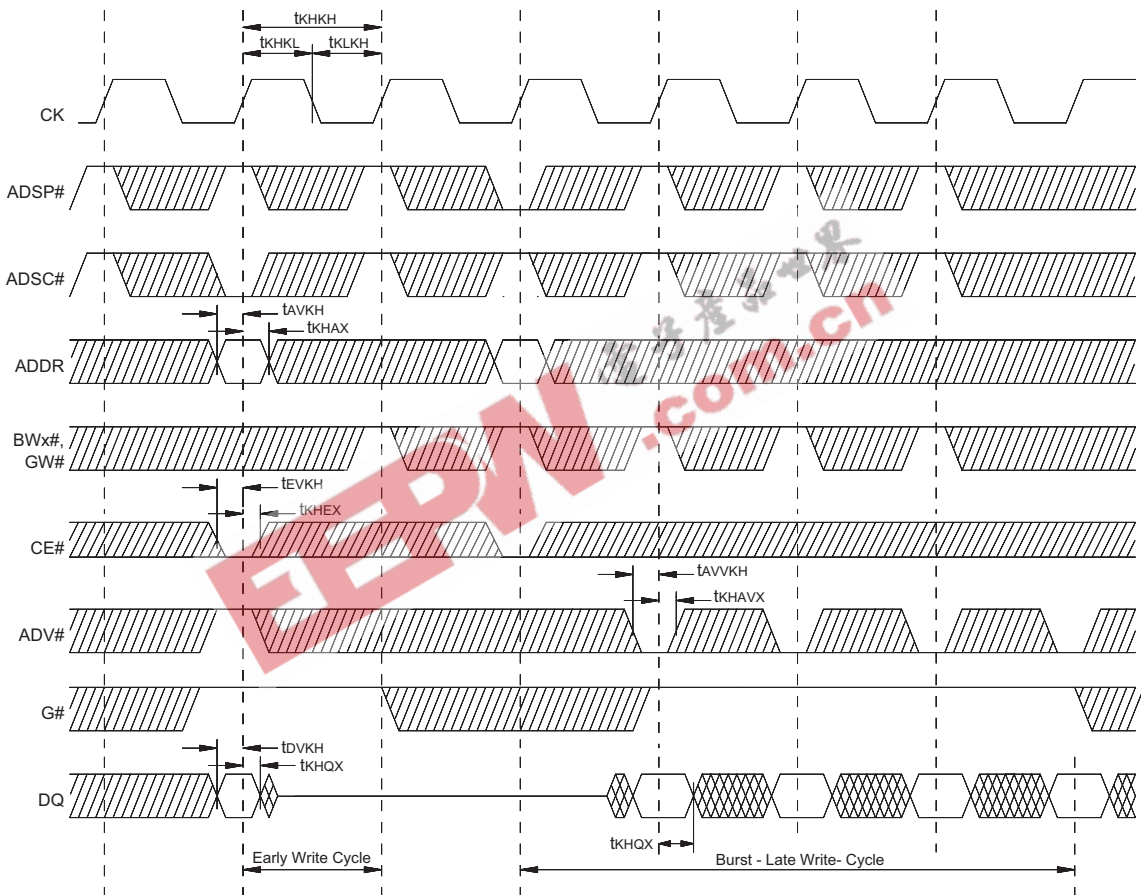

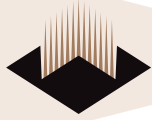



FIG. 6

SYNC-BURST WRITE CYCLE





**PACKAGE DIMENSION: 168 GOLD LEAD DIMM**

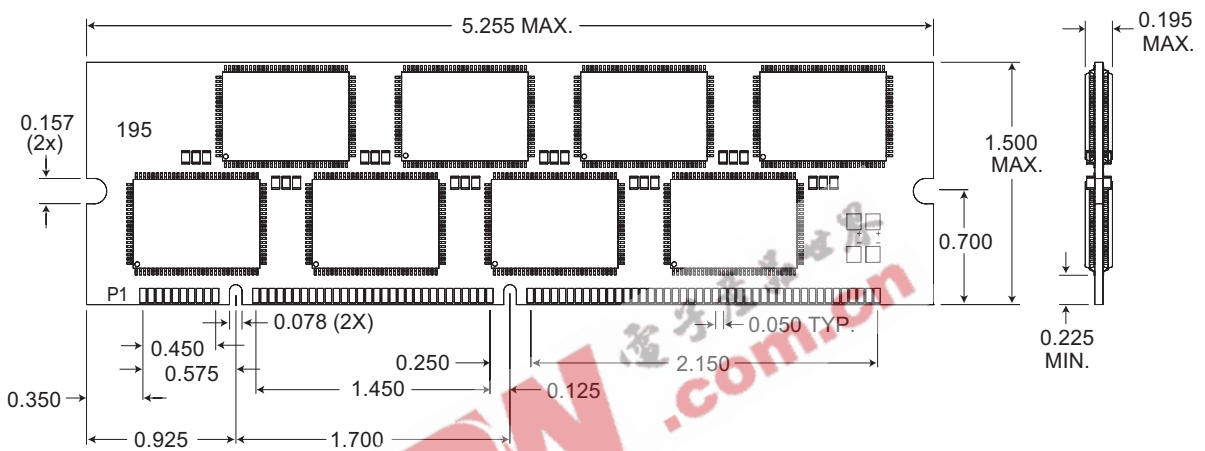

ALL DIMENSIONS ARE IN INCHES

**ORDERING INFORMATION**

Part Number	Configuration	Voltage (V)	Data	Package Access Time
WED2CG472512V9D2	4 x 512K x 72	3.3VDC	9ns	168 Gold Lead DIMM
WED2CG472512V10D2	4 x 512K x 72	3.3VDC	10ns	168 Gold Lead DIMM
WED2CG472512V12D2	4 x 512K x 72	3.3VDC	12ns	168 Gold Lead DIMM
WED2CG472512V15D2	4 x 512K x 72	3.3VDC	15ns	168 Gold Lead DIMM