

W91810N SERIES



23-MEMORY TONE/PULSE DIALER WITH HANDFREE, LOCK AND HOLD FUNCTIONS

GENERAL DESCRIPTION

The W91810N is a series of tone/pulse switchable telephone dialers with 23 memory, keytone, hold, lock, mute, volume control and handfree dialing control features. These chips are fabricated using Winbond's high-performance CMOS technology and thus offer good performance in low-voltage, low-power operations.

FEATURES

- Tone/pulse switchable dialer
- Two by 32 digits redial and save memory
- Three by 32 digits one-touch direct repertory memory
- Twenty by 32 digits one-touch direct or two-touch indirect repertory memory
- Pulse-to-tone (*T) keypad for long distance call operation
- Chain dialing
- Uses 6 × 6 or 7 × 7 keyboard
- Easy operation with redial, flash, pause, and */T keypads
- Pause, P→T (pulse-to-tone) can be stored as a digit in memory
- Dialing rate: 10 or 20 ppS by mask option
- Minimum tone output duration: 93 mS
- Minimum intertone pause: 93 mS
- Pause time: 3.6 sec.
- Flash break time (73 mS, 100 mS, 300 mS, or 600 mS) selectable by keypad; pause time is 1.0 S
- Make/break ratio (2:3 or 1:2) selectable by MODE pin
- Mute key for speech network mute
- No key will be accepted except the "HOLD" key when in the Hold mode
- 4-level volume control by V1 and V2 pin - default value is zero
- Key tone output for valid keypad entry recognition
- On-chip power-on reset
- Uses 3.579545 MHz crystal or ceramic resonator
- 22, 24 or 28-pin dual-in-line plastic package
- The different dialers in the W91810N series are shown in the following table:

TYPE NO.	PULSE (ppS)	MEMORY	LOCK	KEY TONE	HANDFREE DIALING	VOLUME CONTROL	PACKAGE (PINS)
W91810N	10	13 one touch, 10 two touch	-	√	-	-	22
W91810AN	10	13 one touch, 10 two touch	-	√	√	-	24
W91810LN	10	13 one touch, 10 two touch	√	-	-	-	22
W91810ALN	10	13 one touch, 10 two touch	√	-	√	-	24
W91811AN	10	23 one touch	-	√	√	√	28
W91811ALN	10	23 one touch	√	-	√	√	28
W91812N	20	13 one touch, 10 two touch	-	√	-	-	22
W91812AN	20	13 one touch, 10 two touch	-	√	√	-	24
W91813AN	20	23 one touch	-	√	√	√	28

W91810N SERIES



PIN CONFIGURATIONS

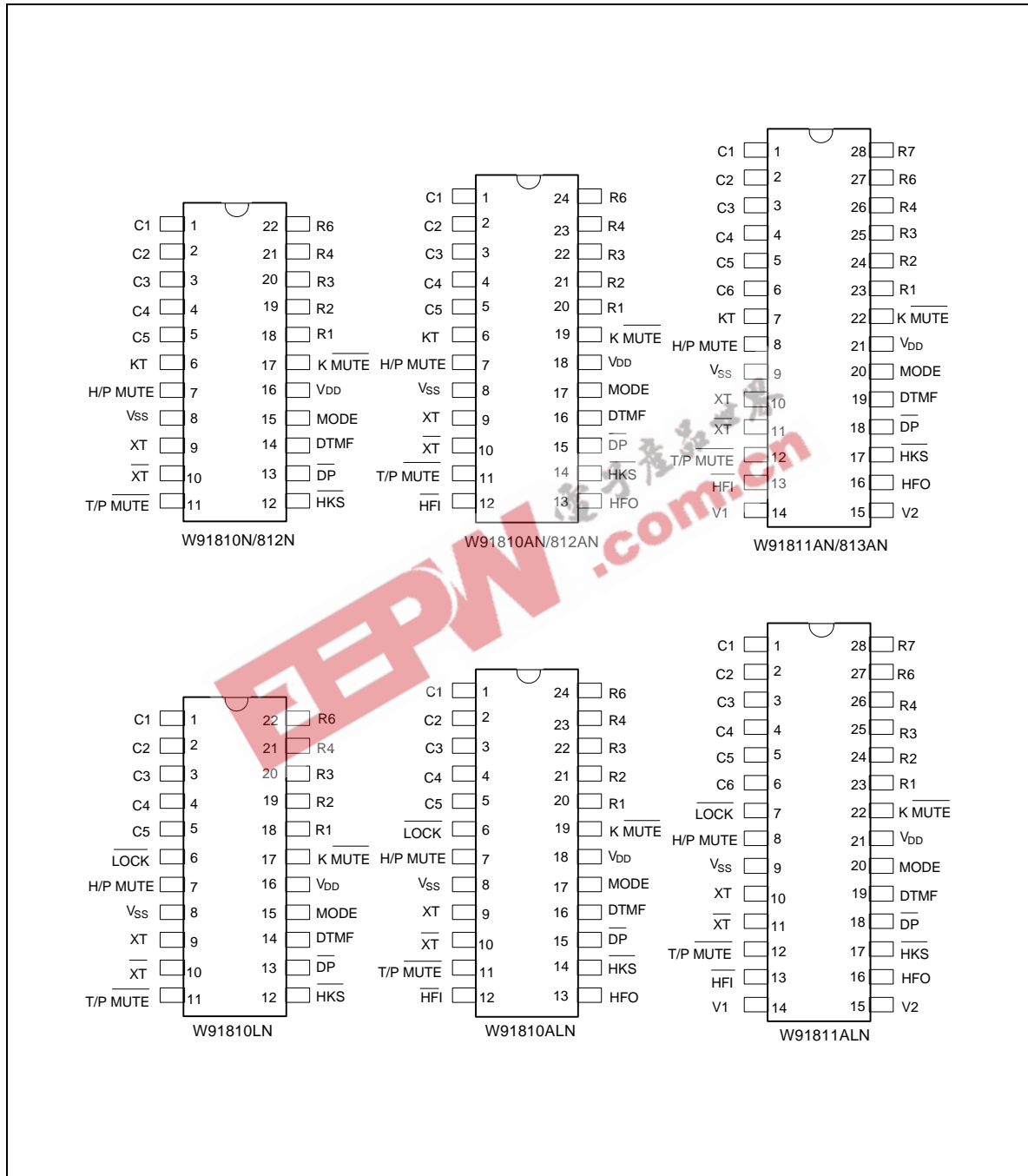

W91810N SERIES



PIN DESCRIPTION

SYMBOL	22-PIN	24-PIN	28-PIN	I/O	FUNCTION
Column-Row Inputs	1-5 & 18-22	1-5 & 20-24	1-6 & 23-28	I	The keyboard input is compatible with a standard 6 × 6 or 7 × 7 keyboard, an inexpensive single contact (Form A) keyboard, and electronic input. In normal operation, any single button can be pushed to produce dual tone, pulses, or functions. Activation of two or more buttons will result in no response except for a single tone.
XT	9	9	10	I	A built-in inverter together with an inexpensive 3.579545 MHz crystal supplies the oscillator. The oscillator stops when there is no keypad input. The crystal frequency deviation is 0.02%.
$\overline{\text{XT}}$	10	10	11	O	Crystal oscillator output pin.
T/P $\overline{\text{MUTE}}$	11	11	12	O	The T/P $\overline{\text{MUTE}}$ is a conventional CMOS N-channel open drain output. The output transistor turns on with a low level during a dialing sequence (both pulse and tone mode). Otherwise, it is off.
K $\overline{\text{MUTE}}$	17	19	22	O	The K $\overline{\text{MUTE}}$ is a conventional CMOS N-channel open drain output. Toggle action speech mute control pin by MUTE key.
MODE	15	17	20	I	Connecting the mode pin to VSS places the dialer in tone mode. Connecting the mode pin to VDD places the dialer in pulse mode with an M/B ratio of 40:60. Leaving the mode pin floating places the dialer in pulse mode with an M/B ratio of 33.3:66.7.
$\overline{\text{HKS}}$	12	14	17	I	The $\overline{\text{HKS}}$ (hook switch) input is used to sense whether the handset is on-hook or off-hook. In on-hook state, $\overline{\text{HKS}} = 1$: chip is in sleeping mode, no operation. In off-hook state, $\overline{\text{HKS}} = 0$: chip is enabled for normal operation. $\overline{\text{HKS}}$ pin is pulled to VDD by internal resistor.

W91810N SERIES



Pin Description, continued

SYMBOL	22-PIN	24-PIN	28-PIN	I/O	FUNCTION								
KT (W91810N/810AN/812N/812AN/811AN/813AN only)	6	6	7	O	The key tone output is a conventional CMOS inverter. The key tone is generated when any valid key is pressed; the KT pin generates a 1.2 KHz square wave at 35 mS. When no key is pressed, the KT pin remains in low state.								
LOCK (W91810LN/810ALN/811ALN only)	6	6	7	I	<p>The function of this terminal is to prevent "0" dialing and "9" dialing under PABX system long distance call control. When the first key input after reset is 0 or 9, all key inputs, including the 0 or 9 key, become invalid and the chip generates no output. The telephone is reinitialized by a reset.</p> <p>The function of the $\overline{\text{LOCK}}$ pin is shown below:</p> <table border="1"> <thead> <tr> <th>LOCK PIN</th> <th>FUNCTION</th> </tr> </thead> <tbody> <tr> <td>VDD</td> <td>"0", "9" dialing inhibited</td> </tr> <tr> <td>Floating</td> <td>Normal dialing Mode</td> </tr> <tr> <td>VSS</td> <td>"0" dialing inhibited</td> </tr> </tbody> </table>	LOCK PIN	FUNCTION	VDD	"0", "9" dialing inhibited	Floating	Normal dialing Mode	VSS	"0" dialing inhibited
LOCK PIN	FUNCTION												
VDD	"0", "9" dialing inhibited												
Floating	Normal dialing Mode												
VSS	"0" dialing inhibited												
H/P MUTE	7	7	8	I	The H/P MUTE is a conventional inverter output. During pulse dialing, flash break or hold period, this output is active high; otherwise, it remains in low state.								
$\overline{\text{DP}}$	13	15	18	O	<p>N-channel open drain dialing pulse output. Flash key will cause $\overline{\text{DP}}$ to be active in either tone mode or pulse mode.</p> <p>In lock mode, the $\overline{\text{DP}}$ remains low for 300 mS during off-hook delay time.</p> <p>The timing diagram for pulse mode is shown in Figure 1(a, b).</p>								

W91810N SERIES



Pin Description, continued

SYMBOL	22-PIN	24-PIN	28-PIN	I/O	FUNCTION																																								
DTMF	14	16	19	O	<p>During pulse dialing, this pin remains in a low state regardless of the keypad input. In tone mode, it will output a dual or single tone.</p> <p>A detailed timing diagram for tone mode is shown in Figure 2(a, b).</p> <table border="1"> <thead> <tr> <th colspan="4">OUTPUT FREQUENCY</th> </tr> <tr> <th></th> <th>Specified</th> <th>Actual</th> <th>Error %</th> </tr> </thead> <tbody> <tr> <td>R1</td> <td>697</td> <td>699</td> <td>+0.28</td> </tr> <tr> <td>R2</td> <td>770</td> <td>766</td> <td>-0.52</td> </tr> <tr> <td>R3</td> <td>852</td> <td>848</td> <td>-0.47</td> </tr> <tr> <td>R4</td> <td>941</td> <td>948</td> <td>+0.74</td> </tr> <tr> <td>C1</td> <td>1209</td> <td>1216</td> <td>+0.57</td> </tr> <tr> <td>C2</td> <td>1336</td> <td>1332</td> <td>-0.30</td> </tr> <tr> <td>C3</td> <td>1477</td> <td>1472</td> <td>-0.34</td> </tr> </tbody> </table>	OUTPUT FREQUENCY					Specified	Actual	Error %	R1	697	699	+0.28	R2	770	766	-0.52	R3	852	848	-0.47	R4	941	948	+0.74	C1	1209	1216	+0.57	C2	1336	1332	-0.30	C3	1477	1472	-0.34				
OUTPUT FREQUENCY																																													
	Specified	Actual	Error %																																										
R1	697	699	+0.28																																										
R2	770	766	-0.52																																										
R3	852	848	-0.47																																										
R4	941	948	+0.74																																										
C1	1209	1216	+0.57																																										
C2	1336	1332	-0.30																																										
C3	1477	1472	-0.34																																										
VDD, VSS	16, 8	18, 8	21, 9	I	Power input pins for the dialer chip. VDD is the power and VSS is the ground.																																								
V1, V2	-	-	14, 15	O	Volume control output pins. These two pins can be toggled by the volume control keys (Vup, Vdown). These two pins output is a conventional CMOS N-channel open drain output.																																								
$\overline{\text{HFI}}$, HFO	-	12, 13	13, 16	I, O	<p>Handfree control pins.</p> <p>A low pulse on the $\overline{\text{HFI}}$ input pin toggles the handfree control state. The status of the handfree control state is listed in the following table:</p> <table border="1"> <thead> <tr> <th colspan="2">CURRENT STATE</th> <th colspan="3">NEXT STATE</th> </tr> <tr> <th>HOOK SW.</th> <th>HFO</th> <th>INPUT</th> <th>HFO</th> <th>DIALING</th> </tr> </thead> <tbody> <tr> <td>-</td> <td>Low</td> <td>$\overline{\text{HFI}} \downarrow$</td> <td>High</td> <td>Yes</td> </tr> <tr> <td>On Hook</td> <td>High</td> <td>$\overline{\text{HFI}} \downarrow$</td> <td>Low</td> <td>No</td> </tr> <tr> <td>Off Hook</td> <td>High</td> <td>$\overline{\text{HFI}} \downarrow$</td> <td>Low</td> <td>Yes</td> </tr> <tr> <td>On Hook</td> <td>-</td> <td>Off Hook</td> <td>Low</td> <td>Yes</td> </tr> <tr> <td>Off Hook</td> <td>Low</td> <td>On Hook</td> <td>Low</td> <td>No</td> </tr> <tr> <td>Off Hook</td> <td>High</td> <td>On Hook</td> <td>High</td> <td>Yes</td> </tr> </tbody> </table> <p>The $\overline{\text{HFI}}$ pin is pulled to VDD by an internal resistor.</p> <p>A detailed timing diagram is shown in Figure 3.</p>	CURRENT STATE		NEXT STATE			HOOK SW.	HFO	INPUT	HFO	DIALING	-	Low	$\overline{\text{HFI}} \downarrow$	High	Yes	On Hook	High	$\overline{\text{HFI}} \downarrow$	Low	No	Off Hook	High	$\overline{\text{HFI}} \downarrow$	Low	Yes	On Hook	-	Off Hook	Low	Yes	Off Hook	Low	On Hook	Low	No	Off Hook	High	On Hook	High	Yes
CURRENT STATE		NEXT STATE																																											
HOOK SW.	HFO	INPUT	HFO	DIALING																																									
-	Low	$\overline{\text{HFI}} \downarrow$	High	Yes																																									
On Hook	High	$\overline{\text{HFI}} \downarrow$	Low	No																																									
Off Hook	High	$\overline{\text{HFI}} \downarrow$	Low	Yes																																									
On Hook	-	Off Hook	Low	Yes																																									
Off Hook	Low	On Hook	Low	No																																									
Off Hook	High	On Hook	High	Yes																																									

W91810N SERIES



BLOCK DIAGRAM

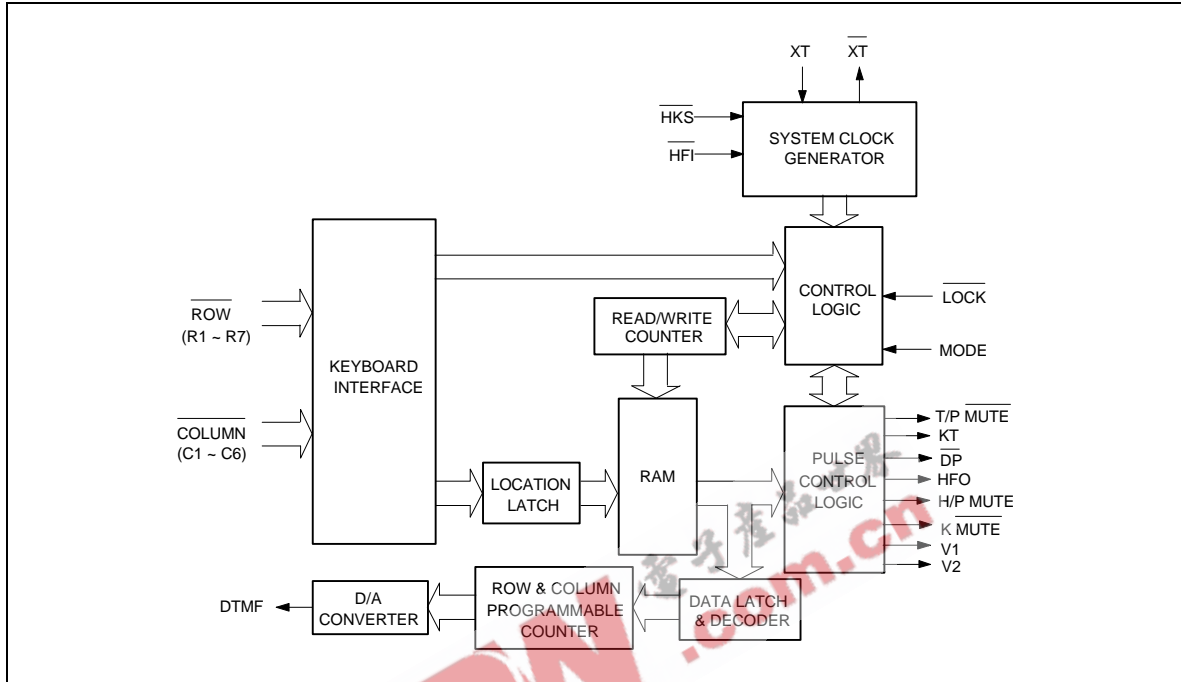

FUNCTIONAL DESCRIPTION

Keyboard Operation

C1	C2	C3	C4	C5	Vss	
1	2	3	S	M0	EM1	R1
4	5	6	F4	M1	EM2	R2
7	8	9	Page	M2	EM3	R3
*/T	0	#	R/P	M3	SAVE	R4
F1	F2	F3	H	M4		Vx/R5
M5	M6	M7	M8	M9	MUTE	R6

C1	C2	C3	C4	C5	C6	Vss	
1	2	3	S	M0	M10	EM1	R1
4	5	6	F4	M1	M11	EM2	R2
7	8	9	Page	M2	M12	EM3	R3
*/T	0	#	R/P	M3	M13	SAVE	R4
F1	F2	F3	H	M4	M14		Vx/R5
M5	M6	M7	M8	M9	R	MUTE	R6
M15	M16	M17	M18	M19	Vup	Vdown	R7

- S: Store function key

W91810N SERIES



- Page: Indirect repertory memory dialing function key
- H: Hold function key
- R: One key redial function key
- R/P: Redial and pause function key
- *T: * in tone mode and P→T key in pulse mode
- SAVE: Save function key for one-touch 32-digit memory
- MUTE: Mute function key for speech mute
- M0–M9: One touch memory. The dialing number can be stored in M0–M9 locations by the S key. Note that the two touch memory (Page+ 0... Page+9) share the same memory buffer with M10–M19, respectively
- M10, ..., M19: One touch or two touch memory keys. If there are no M10–M19 keys, Page+(M0–M9) can be used to simulate M10–M19.
- EM1, ..., EM3: Emergency one-touch memory key
- A: Indiect repertory dialing function key
- F1, ..., F4: Flash function keys: F1 = 600 mS, F2 = 300 mS, F3 = 73 mS, F4 = 100 mS; all flash pause time is 1.0 S

Note: D1, ..., Dn, D1', ..., Dn', *T, #, Mm: M0, ..., M9, Mn: M0, ..., M19, Ln: 0–9

$$\boxed{\text{PAGE}} + \boxed{\text{LN}} = \boxed{\text{PAGE}} + \boxed{\text{Mm}} = \boxed{\text{M10-M19}}$$

Normal Dialing

$\boxed{\text{OFF HOOK}}$ (or $\boxed{\text{ON HOOK}}$ & $\boxed{\overline{\text{HFI}} \downarrow}$), $\boxed{\text{D1}}$, $\boxed{\text{D2}}$, ..., $\boxed{\text{Dn}}$

1. D1, D2, ..., Dn will be dialed out.
2. Dialing length is unlimited, but redial is inhibited if length oversteps 32 digits in normal dialing.

Redialing Dialing

1. $\boxed{\text{OFF HOOK}}$ (or $\boxed{\text{ON HOOK}}$ & $\boxed{\overline{\text{HFI}} \downarrow}$, $\boxed{\text{D1}}$, $\boxed{\text{D2}}$, ..., $\boxed{\text{Dn}}$, BUSY

Come $\boxed{\text{ON HOOK}}$, $\boxed{\text{OFF HOOK}}$ (or $\boxed{\text{ON HOOK}}$ & $\boxed{\overline{\text{HFI}} \downarrow}$), $\boxed{\text{R/P}}$

The $\boxed{\text{R/P}}$ key can execute redial function only as first key-in after off-hook. Otherwise, it will invoke the pause function.

2. $\boxed{\text{OFF HOOK}}$ (or $\boxed{\text{ON HOOK}}$ & $\boxed{\overline{\text{HFI}} \downarrow}$), $\boxed{\text{D1}}$, $\boxed{\text{D2}}$, ..., $\boxed{\text{Dn}}$, $\boxed{\text{R}}$

a. The one-key redial function timing diagram is shown in Figure 5.

b. If dialing of $\boxed{\text{D1}}$ to $\boxed{\text{Dn}}$ is finished, pressing $\boxed{\text{R}}$ key will cause the pulse output pin to go low for 2.2 seconds break time and a 600ms pause will automatically be added.

W91810N SERIES



- c. If the pulses of the dialed number $D1$ to Dn have not finished, R will be ignored.
3. $OFF\ HOOK$ (or $ON\ HOOK$ & $\overline{HFI}\downarrow$), $D1$, $D2$, ..., Dn , Busy $ON\ HOOK$ come, $OFF\ HOOK$, OKR (or R/P)

If R is the first key after OFF HOOK, it only can execute the redialing function but will not cause the pulse output pin to go low for the break time of 2.2 seconds.

Number Store

1. $OFF\ HOOK$ (or $ON\ HOOK$ & $\overline{HFI}\downarrow$), $D1$, $D2$, ..., Dn , S , S , Mn (or $PAGE$, Ln or EMn or $SAVE$ or $PAGE$, Mm)
- a. The dialing out of $D1$ to Dn must first be finished before the S key is pressed.
- b. $D1, D2, \dots, Dn$ will be stored in memory location Mn or saved and then dialed out.
2. $OFF\ HOOK$ (or $ON\ HOOK$ & $\overline{HFI}\downarrow$), S , $D1$, $D2$, ..., Dn , S , Mn (or Ln or EMn or $SAVE$ or $PAGE$, Mm)
- a. $D1, D2, \dots, Dn$ will be stored in memory location, Mn (or saved), but will not be dialed out.
- b. R/P and $*T$ keys can be stored as a digit in memory, but the R/P key cannot be the first digit. In store mode, R/P is the pause function key.
- c. The store mode is released after the store function is executed or when the state of the hook switch changes or the flash function is executed.

Save

- $OFF\ HOOK$ (or $ON\ HOOK$ & $\overline{HFI}\downarrow$), $D1$, $D2$, ..., Dn , $SAVE$
- a. $D1, D2, \dots, Dn$ will be dialed out.
- b. If the dialing of $D1$ to Dn is finished, pressing $SAVE$ will duplicate $D1$ to Dn to the save memory.
- $OFF\ HOOK$ (or $ON\ HOOK$ & $\overline{HFI}\downarrow$),
- come on $OFF\ HOOK$ (or $ON\ HOOK$ & $\overline{HFI}\downarrow$), $SAVE$
- c. $D1$ to Dn will be dialed out after the $SAVE$ key is pressed.



Repertory Dialing Procedure

One-touch direct repertory dialing:

(or &), (or or)

Two-touch direct repertory dialing:

(or &), , (or)

Access Pause

(or &), , , , , ...,

1. The pause function can be stored in memory.
2. The pause function is executed with normal dialing, redialing or memory dialing.
3. The pause function timing diagram is shown in Figure 6.

Pulse-to-tone (*T)

(or &), , , ..., , , ,
 , ...,

1. If the mode switch is set in pulse mode, then it will perform
 , , ---, , , , , ---,
(Pulse) (Tone)
2. If the mode switch is set in tone mode, then the output signal will be:
 , , ---, , * , , , ---,
(Tone) (Tone)
3. It can be reset to pulse mode only if ON HOOK is active. This is because it remains in tone mode when the digits have been dialed out.
4. The function timing diagram is shown in Figure 7.

Flash

(or &),

1. $F_n = F_1 - F_4$. If is pressed, the dialer will execute a flash break time of 600 mS (F1), 300 mS (F2), 73 mS (F3) or 100 mS (F4) and a pause time of 1.0 second, after which the next digit is dialed out.
2. The flash key has the first priority of the keyboard function only one flash key will be released to the user.
3. When the flash key is key in, the system will return to the initial state after the flash pause time is finished.
4. The flash function timing diagram is shown in Figure 8.

W91810N SERIES



Cascaded Dialing

OFF HOOK (or ON HOOK & $\overline{\text{HFI}} \downarrow$)

1. Normal Dialing + Repertory Dialing + Normal Dialing
(1st sequence) (2nd sequence)
2. Repertory Dialing + Normal Dialing + Repertory Dialing
(1st sequence) (2nd sequence)
3. Redialing + Normal Dialing + Repertory Dialing
(1st sequence) (2nd sequence)

Redialing is valid only for the first key-in.

The second sequence should not be operated until the first sequence is dialed out completely.

Mute

OFF HOOK , MUTE

MUTE has an on/off toggle function.

ABSOLUTE MAXIMUM RATING

PARAMETER	SYMBOL	RATING	UNIT
DC Supply Voltage	VDD-VSS	-0.3 to +7.0	V
Input/Output Voltage	VIL	VSS-0.3	V
	VIH	VDD+0.3	V
	VOL	VSS-0.3	V
	VOH	VDD+0.3	V
Power Dissipation	PD	120	mW
Operation Temperature	TOPR	-20 to +70	°C
Storage Temperature	TSTG	-55 to +150	°C

Note: Exposure to conditions beyond those listed under Absolute Maximum Ratings may adversely affect the life and reliability of the device.

W91810N SERIES



DC CHARACTERISTICS

(VDD-VSS = 2.5V, Fosc. = 3.58 MHz, TA = 25° C, all outputs unloaded)

PARAMETER	SYM.	CONDITIONS	MIN.	TYP.	MAX.	UNIT
Operating Voltage	VDD	-	2.0	-	5.5	V
Operating Current	IOP	Tone	-	0.4	0.6	mA
		Pulse	-	0.2	0.4	mA
Standby Current	ISB	HKS = 0, No load & No key entry	-	-	15	μA
Memory Retention Current	IMR	HKS = 1, VDD = 1.0V	-	-	0.2	μA
Tone Output Voltage	VTO	Row group, RL = 5 KΩ	130	150	170	mVrms
Pre-emphasis		Col/Row, VDD = 2.0-5.5V	1	2	3	dB
DTMF Distortion	THD	RL = 5 KΩ, VDD = 2.0-5.5V	-	-30	-23	dB
DTMF Output DC Level	VTDC	RL = 5 KΩ, VDD = 2.0-5.5V	1.0	-	3.0	V
DTMF Output Sink Current	ITL	VTO = 0.5V	0.2	-	-	mA
DP Output Sink Current	IPL	VPO = 0.5V	0.5	-	-	mA
T/P MUTE Output Sink Current	IML	VMO = 0.5V	0.5	-	-	mA
KT Drive/Sink Current	IKTH	VKTH = 2.0V	0.5	-	-	mA
	IKTL	VKTL = 0.5V	0.5	-	-	mA
HFO Drive/Sink Current	IHFH	VHFH = 2.0V	0.5	-	-	mA
	IHFL	VHFL = 0.5V	0.5	-	-	mA
K MUTE Sink Current	IKML	VKML = 0.5V	0.5	-	-	mA
H/P MUTE	IHPH	VHPH = 2.0V	0.5	-	-	mA
Drive/Sink Current	IHPL	VHPL = 0.5V	0.5	-	-	mA
Keypad Input Drive Current	IKD	VI = 0V	4	-	-	μA
HKS Pull High Resister	RHKS		300	500	-	KΩ
Keypad Input Sink Current	IKS	VI = 2.5V	200	400	-	μA
Keypad Resistance			-	-	5.0	KΩ

W91810N SERIES



AC CHARACTERISTICS

PARAMETER	SYM.	CONDITIONS	MIN.	TYP.	MAX.	UNIT
Key-in Debounce	TKID	-	-	20	-	mS
Key Release Debounce	TKRD	-	-	20	-	mS
On-hook Debounce	TOHD	Lock Mode	-	20	-	mS
		Unlock Mode	-	150	-	mS
Pre-digit Pause ¹	TPDP1	Mode Pin = VDD	-	40	-	mS
		10 ppS Mode Pin = Floating	-	33.3	-	mS
Pre-digit Pause ²	TPDP2	Mode Pin = VDD	-	20	-	mS
		20 ppS Mode Pin = Floating	-	16.7	-	mS
Inter Digit Pause (Auto Dialing)	TIDP	10 ppS (Unless W91810N/ W91810AN/ 810LN/810ALN/811AN/811ALN only)	-	800	-	mS
		20 ppS (W91812N/812AN/813AN only)	-	500	-	mS
Interdigit Pause (Auto dialing)	TIDP	10 ppS	-	800	-	mS
		20 ppS	-	500	-	mS
Make/Break Ratio	M:B	Mode Pin = VDD	-	40:60	-	%
		Mode Pin = Floating	-	33.3:66.7	-	%
Tone Output Duration	TTD	-	-	93	-	mS
Intertone Pause	TITP	-	-	93	-	mS
Flash Break Time	TFB	F1	-	600	-	mS
		F2	-	300	-	
		F3	-	73	-	
		F4	-	100	-	
Flash Pause Time	TFP	-	-	1.0	-	S
Pause Time	TP	-	-	3.6	-	S
Key Tone Frequency	FKT	-	-	1.2	-	KHz
Key Tone Duration	TKTD	-	-	35	-	mS
One-key Redialing Pause Time	TRP	-	-	600	-	mS
One-key Redialing Break Time	TRB	-	-	2.2	-	S
First Key-in Delay	TFKD	Lock only	-	300	-	mS

Notes:

- Crystal parameters suggested for proper operation are $R_s < 100 \Omega$, $L_m = 96 \text{ mH}$, $C_m = 0.02 \text{ pF}$, $C_n = 5 \text{ pF}$, $C_l = 18 \text{ pF}$, $F_{osc} = 3.579545 \text{ MHz} \pm 0.02\%$.
- Crystal oscillator accuracy directly affects these times.



VOLUME CONTROL FLOW CHART

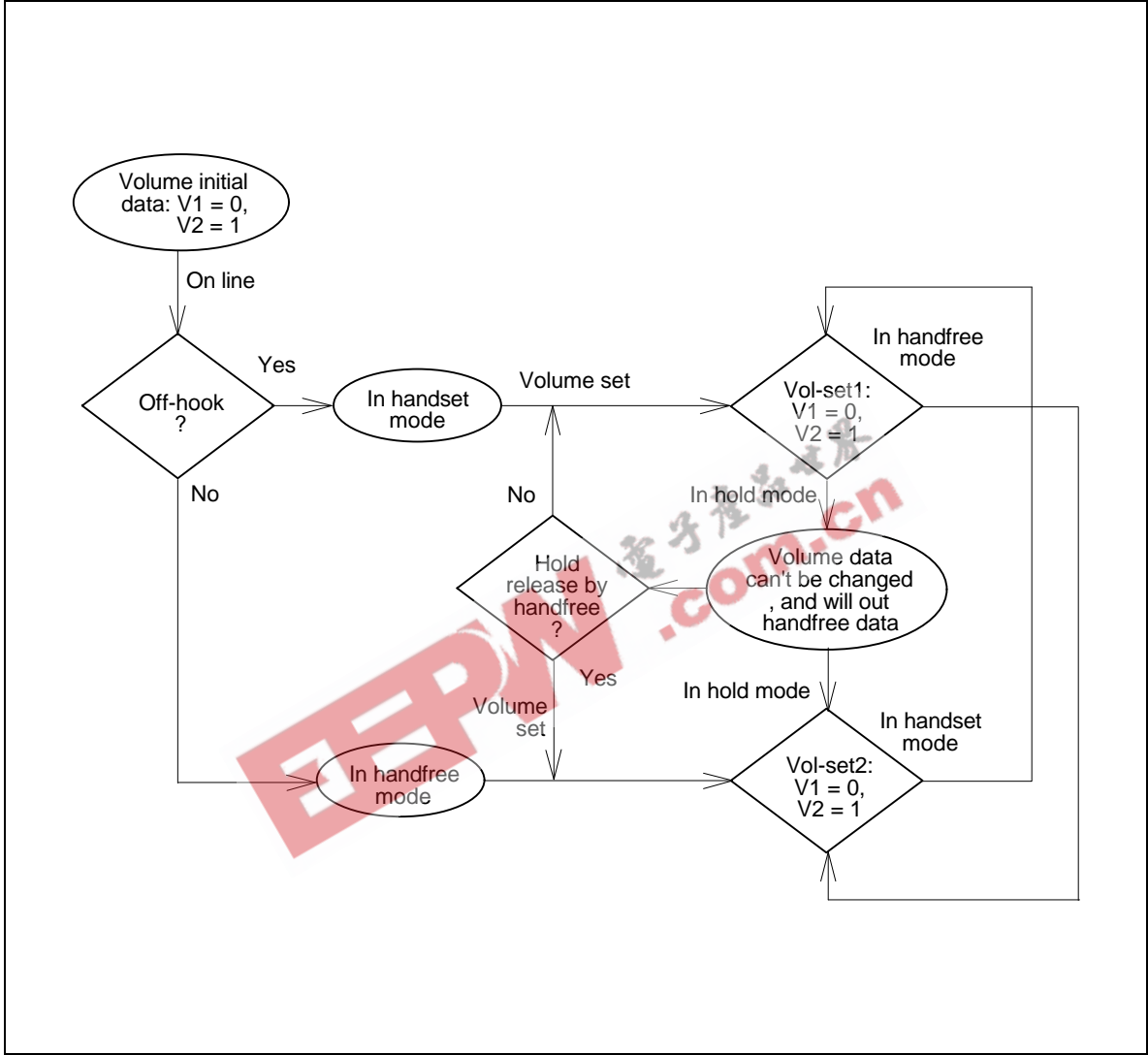

W91810N SERIES



Volume Control Flow Chart, continued

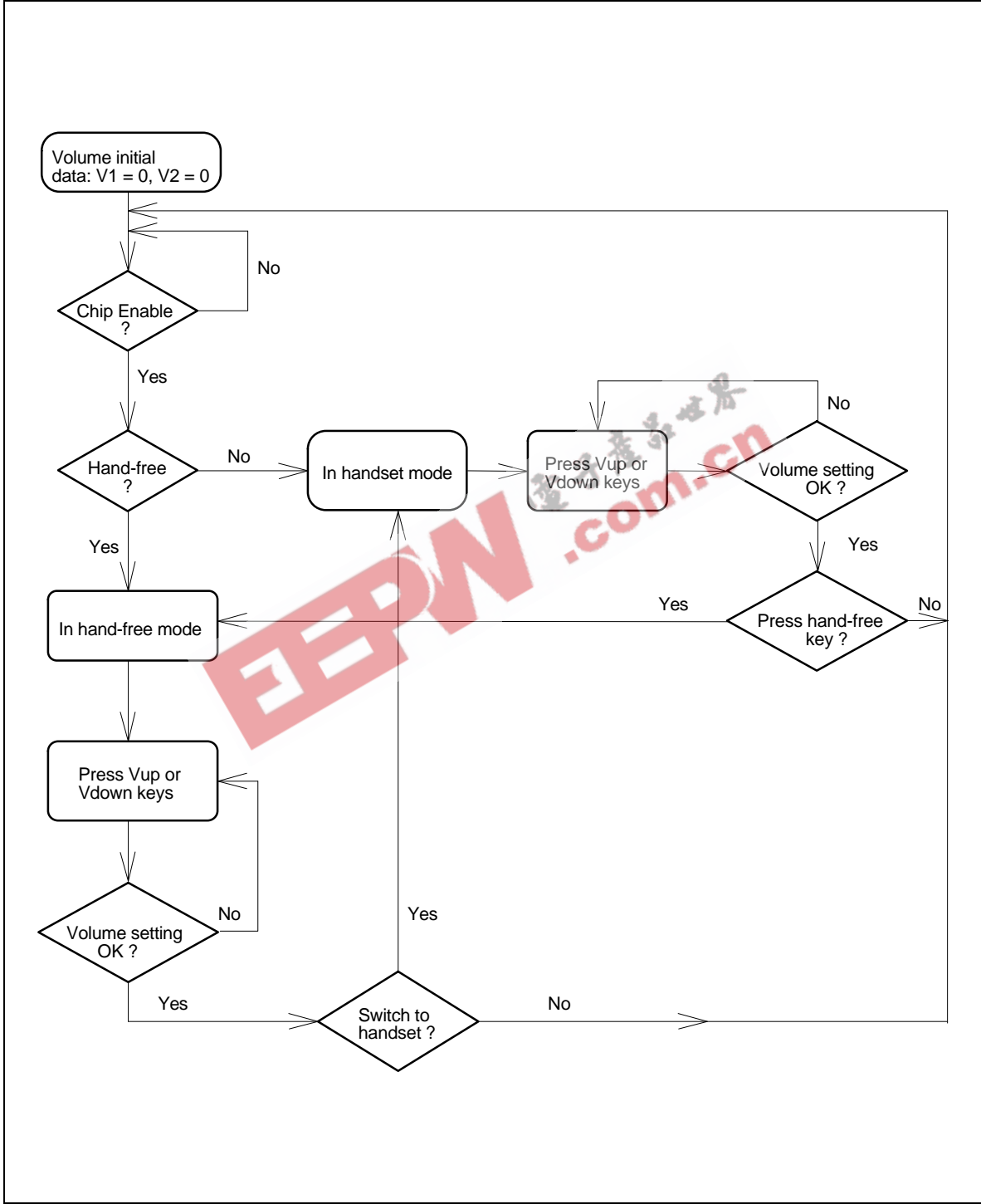

W91810N SERIES



TIMING WAVEFORMS

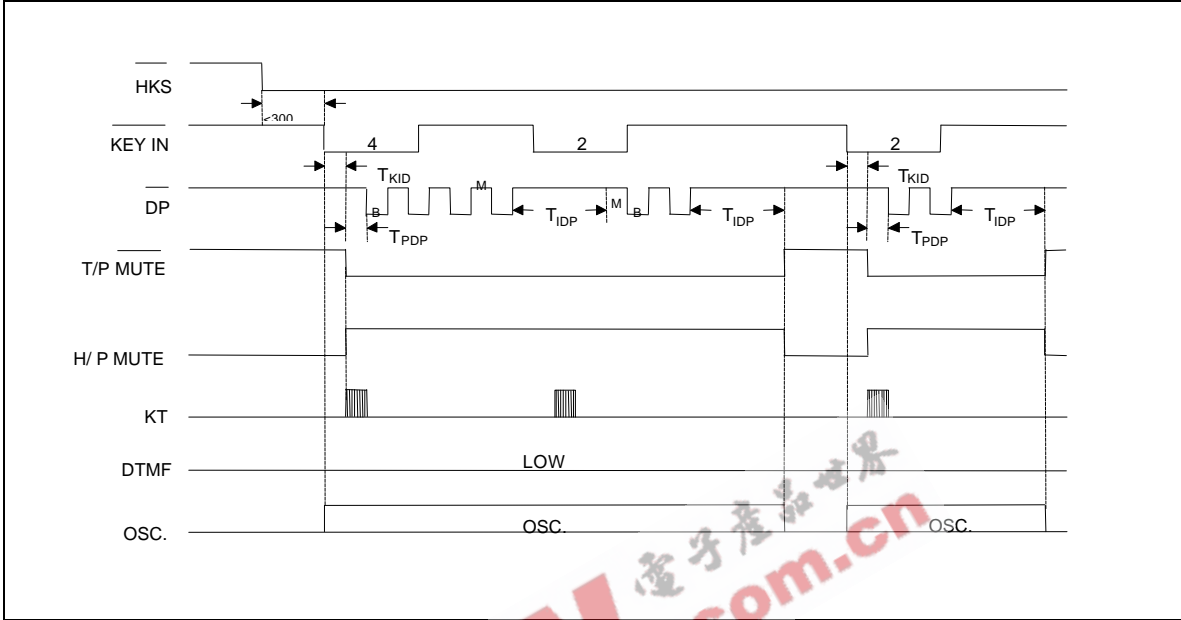

Figure 1(a) Pulse Mode Timing Diagram (Normal dialing without lock)

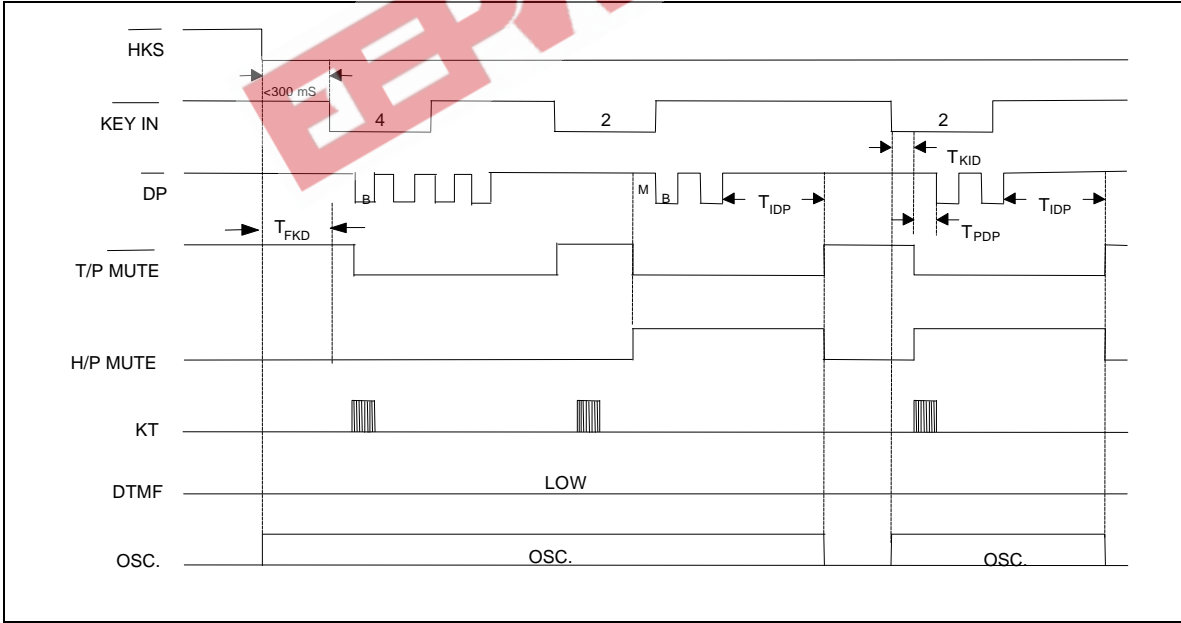

Figure 1(b) Pulse Mode Timing Diagram (Normal dialing with lock function)

W91810N SERIES



Timing Waveforms, continued

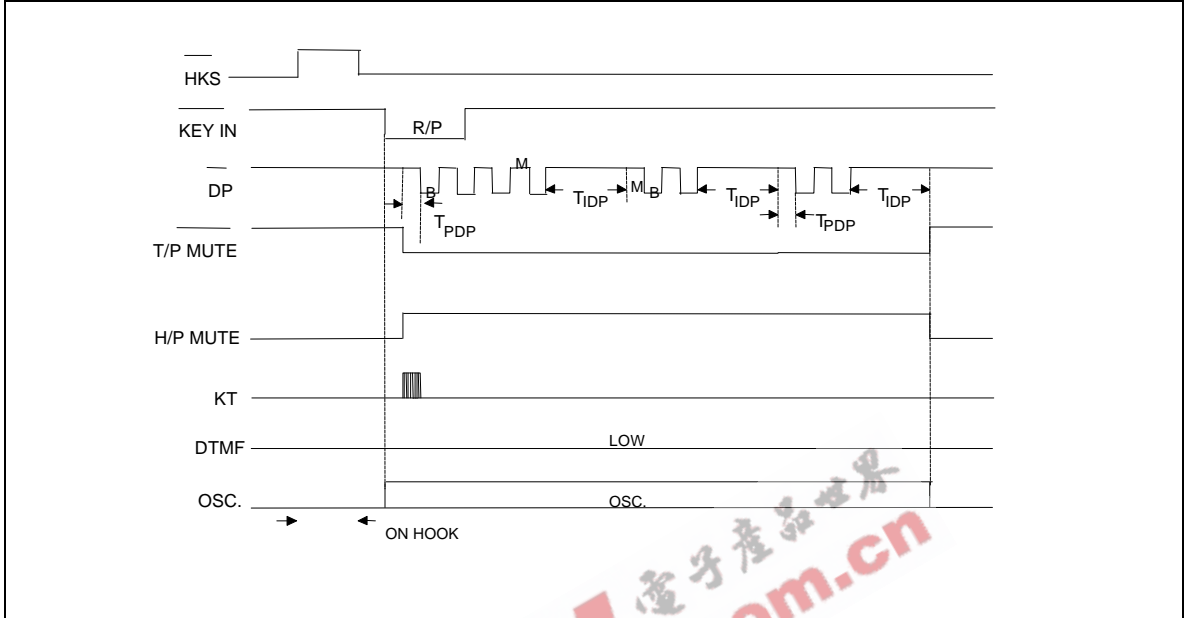

Figure 1(c) Pulse Mode Timing Diagram (Auto dialing without lock)

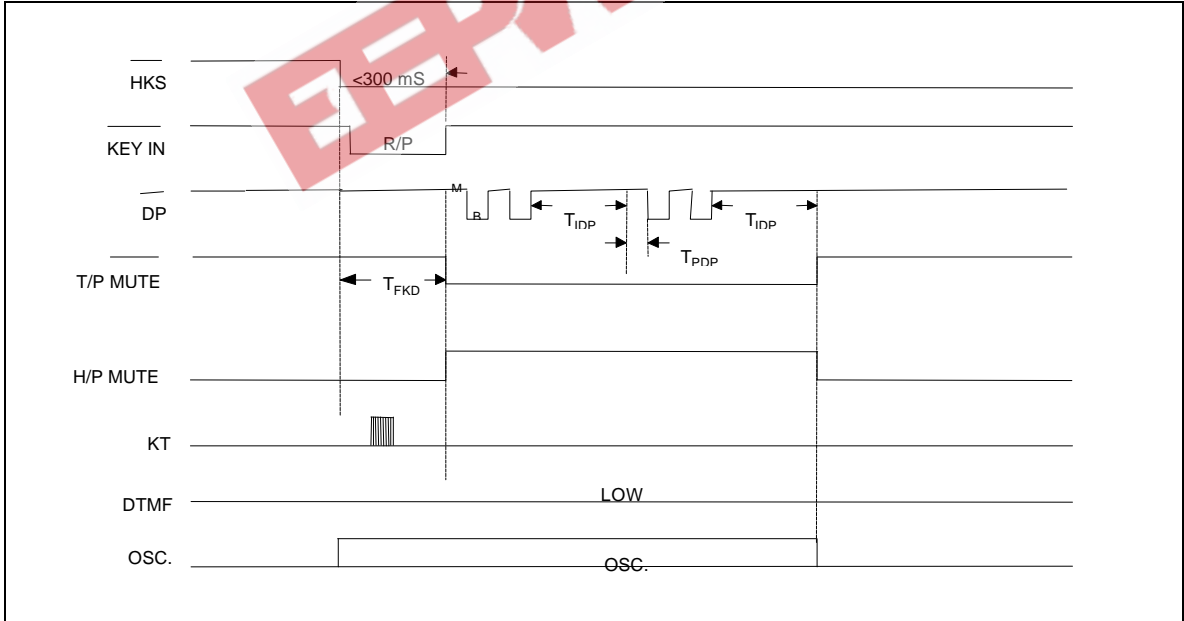

Figure 1(d) Pulse Mode Timing Diagram (Auto dialing with lock function)

W91810N SERIES



Timing Waveforms, continued

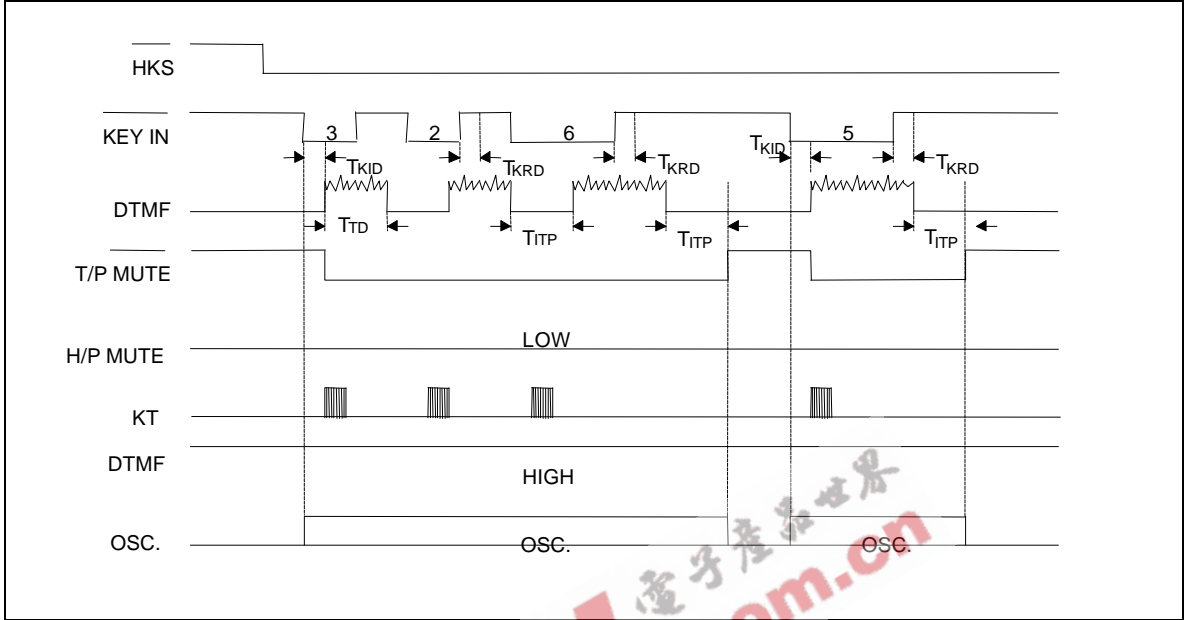

Figure 2(a) Tone Mode Timing Diagram (Normal dialing without lock)

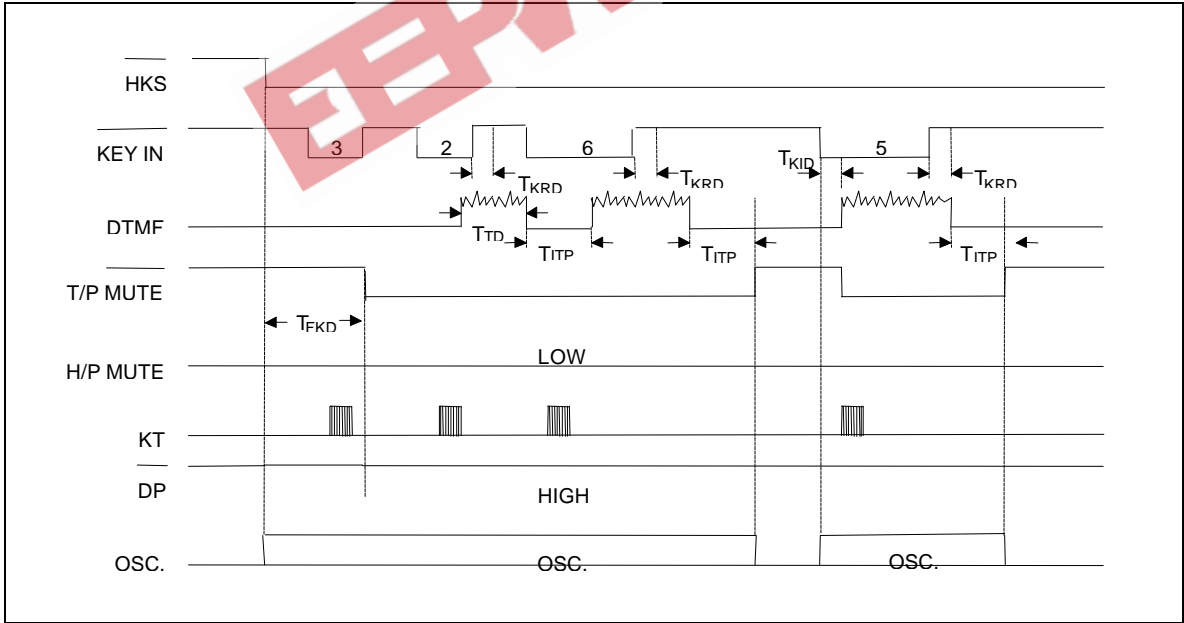

Figure 2(b) Tone Mode Timing Diagram (Normal dialing with lock function)

W91810N SERIES



Timing Waveforms, continued

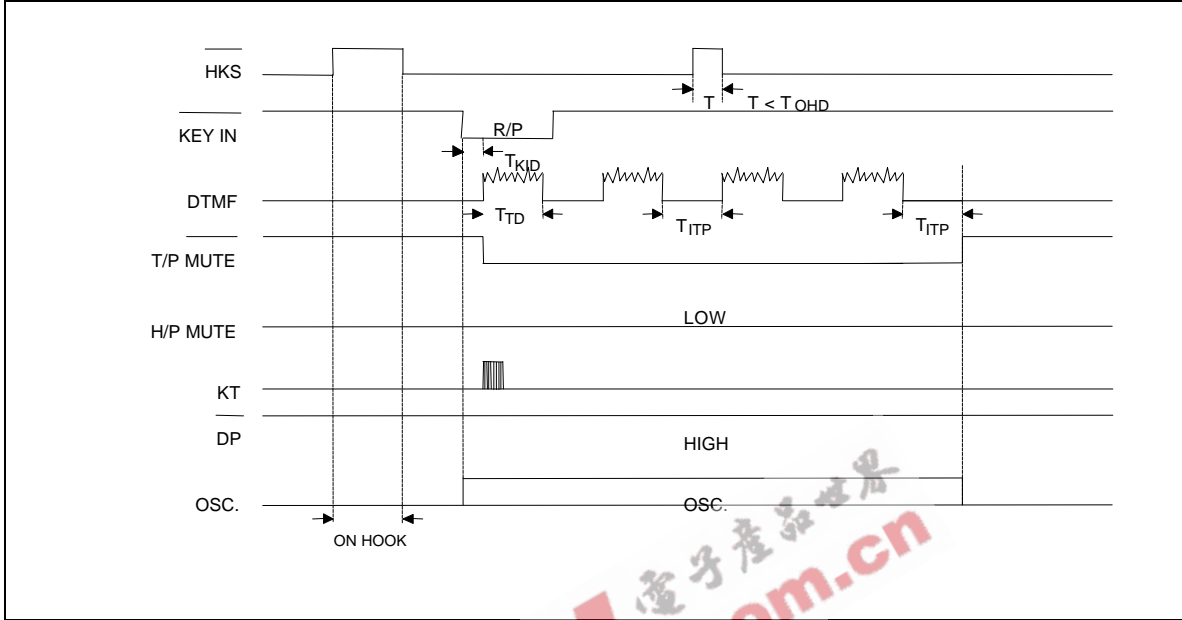

Figure 2(c) Tone Mode Timing Diagram (Auto dialing without lock)

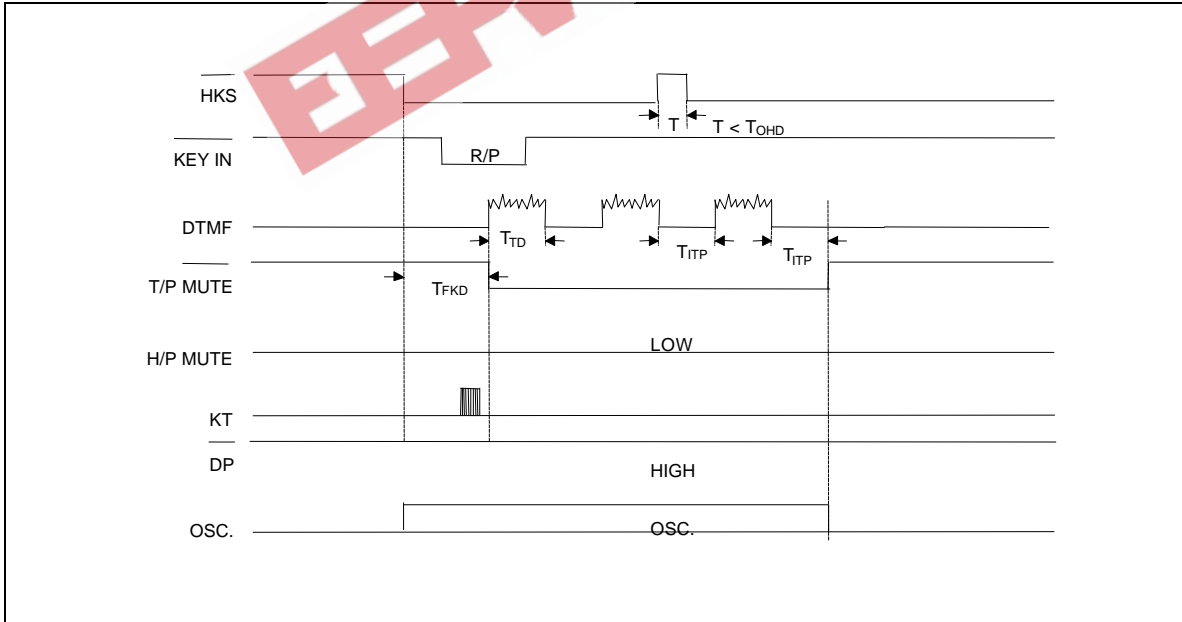

Figure 2(d) Tone Mode Timing Diagram (Auto dialing with lock function)

W91810N SERIES



Timing Waveforms, continued

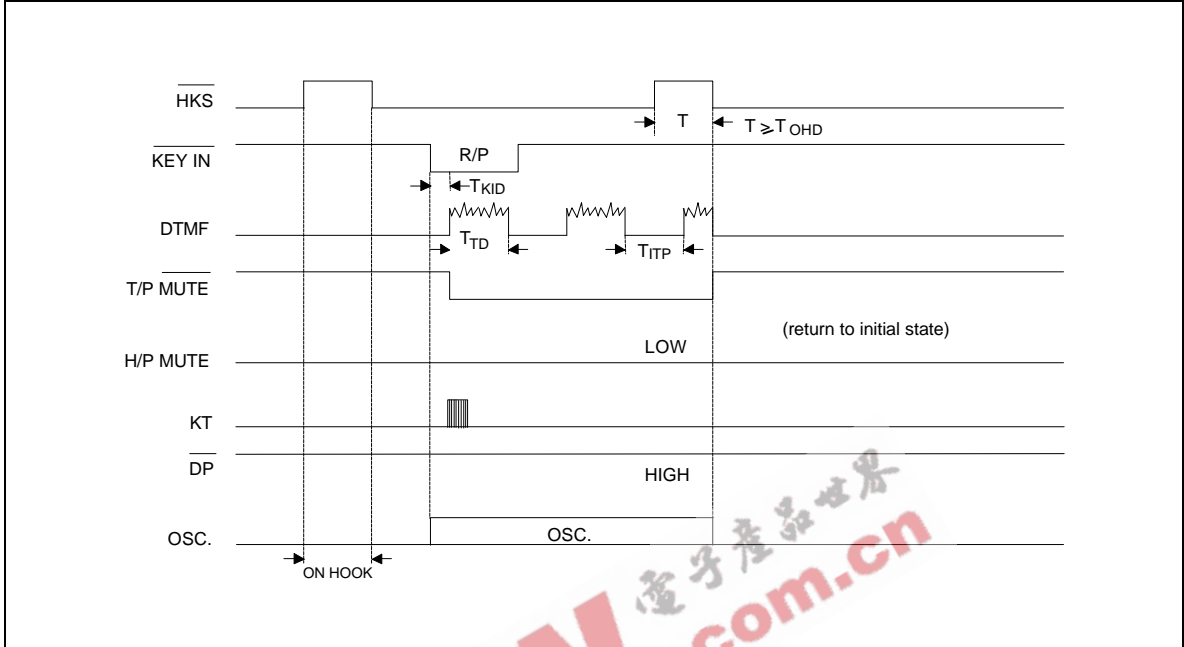

Figure 2(e) Tone Mode Timing Diagram with On-hook Debounce (Auto dialing)

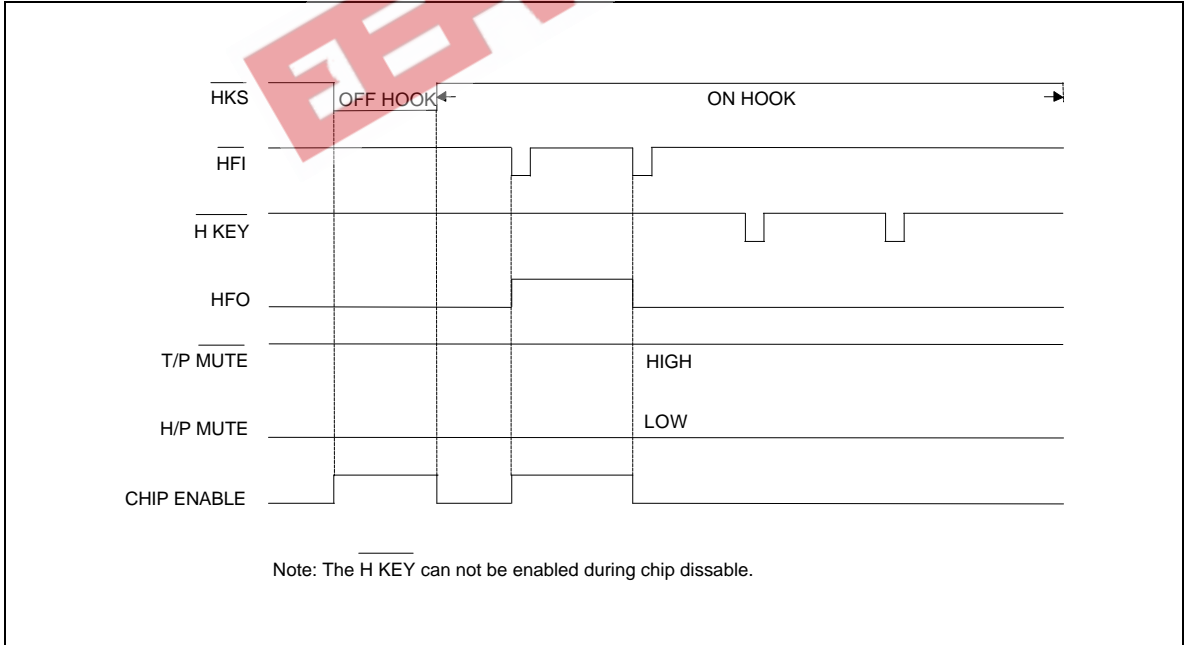

Figure 3(a)

W91810N SERIES



Timing Waveforms, continued

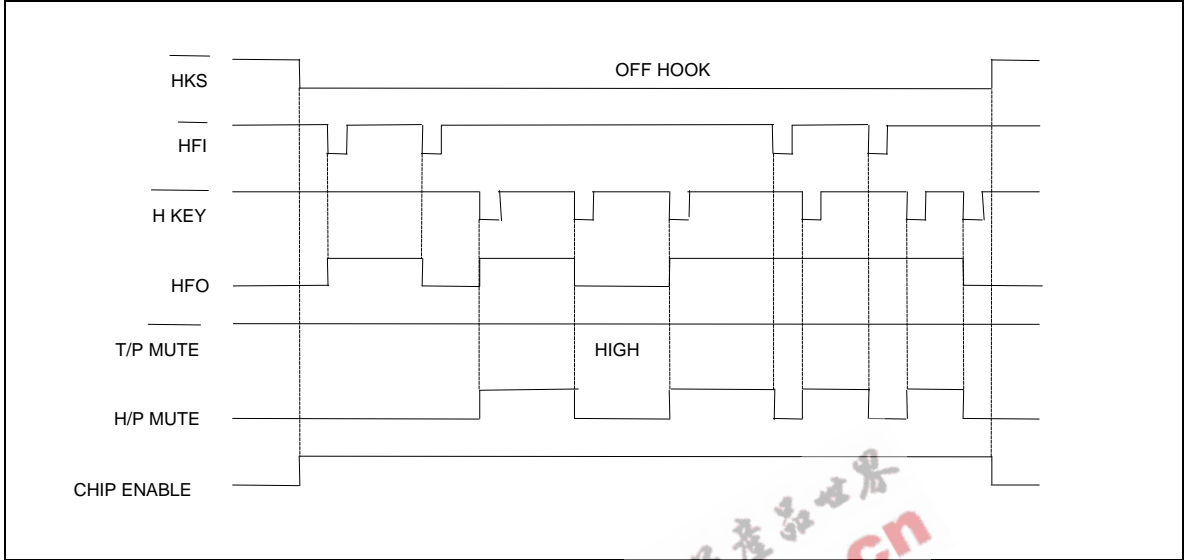

Figure 3(b)

Note: The H KEY and HFI inputs will toggle the HFO signal. The first time HFI or H KEY are activated, the HFO signal will go high and the previous active input will be neglected.

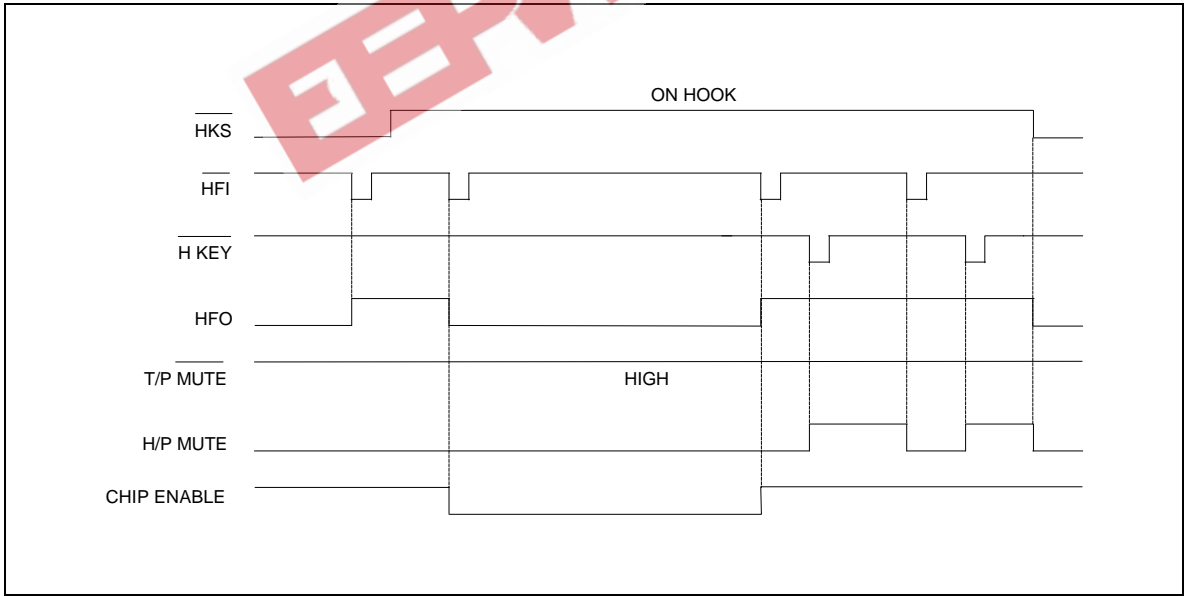

Figure 3(c)

Note: The HKS signal change of state from high to low will initialize both the HFO and H/P MUTE signals.

W91810N SERIES



Timing Waveforms, continued

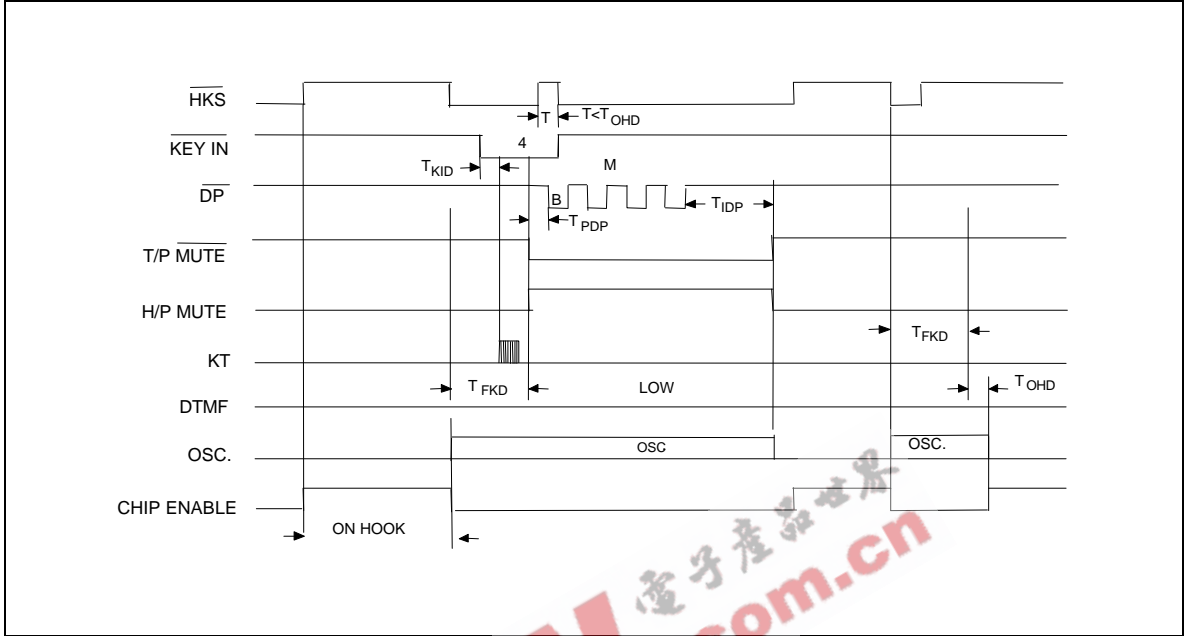

Figure 4 Lock Function Timing Diagram

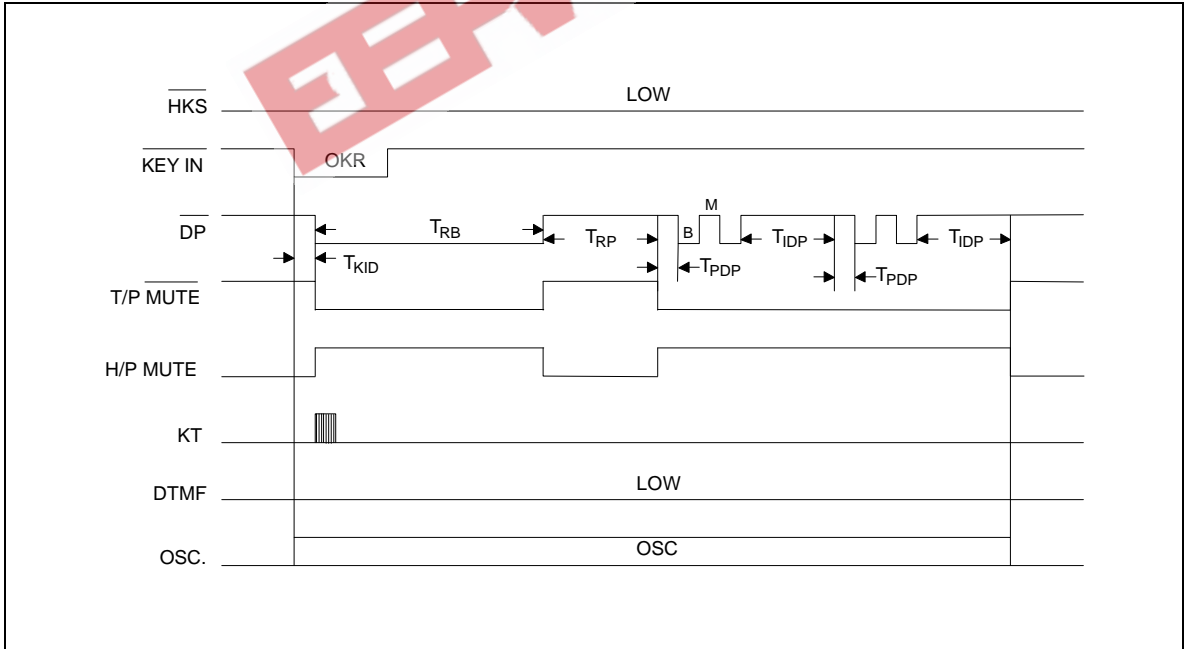

Figure 5 Pulse Mode One-key Dedialing Timing Diagram

W91810N SERIES



Timing Waveforms, continued

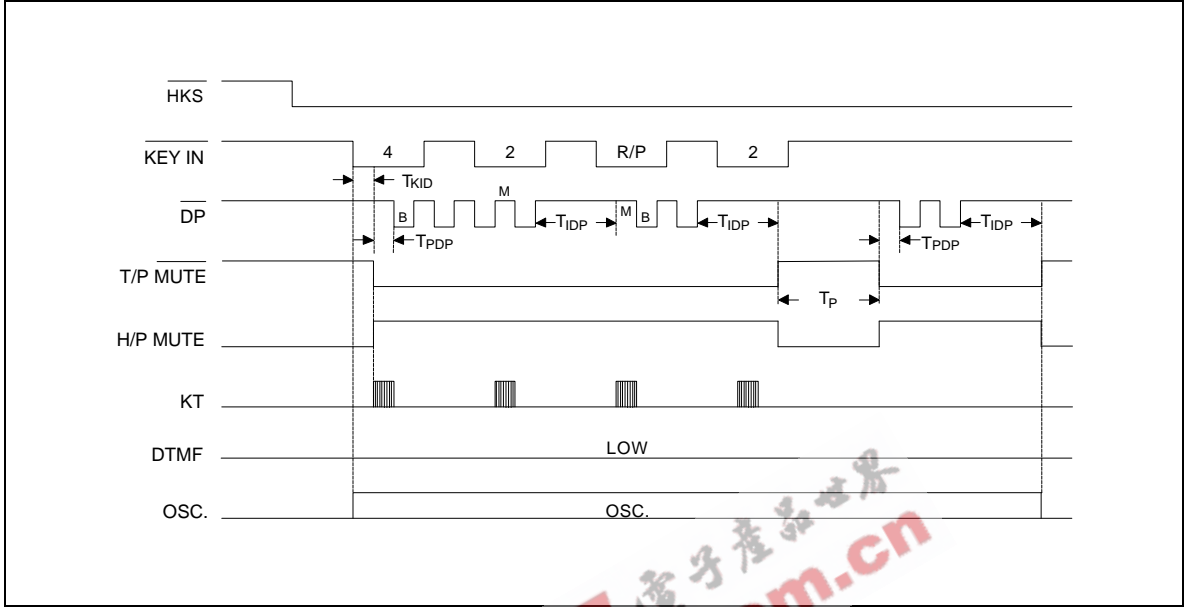

Figure 6 Pause Function Timing Diagram

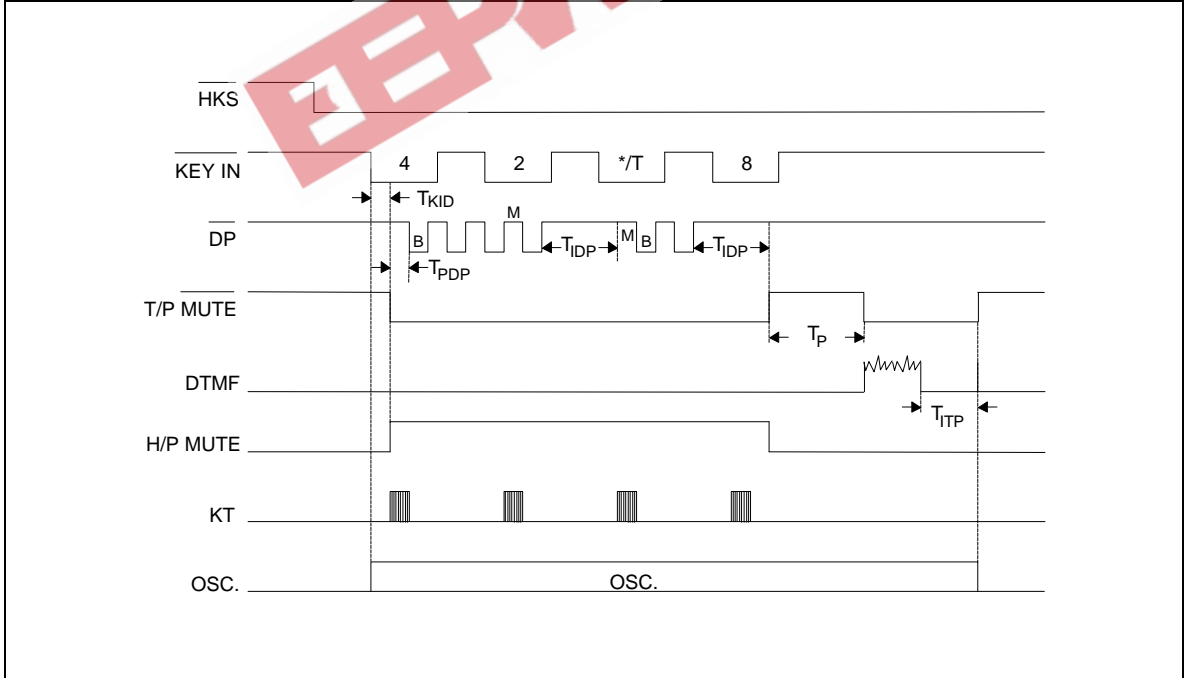

Figure 7. Pulse to Tone Function Timing Diagram

W91810N SERIES



Timing Waveforms, continued

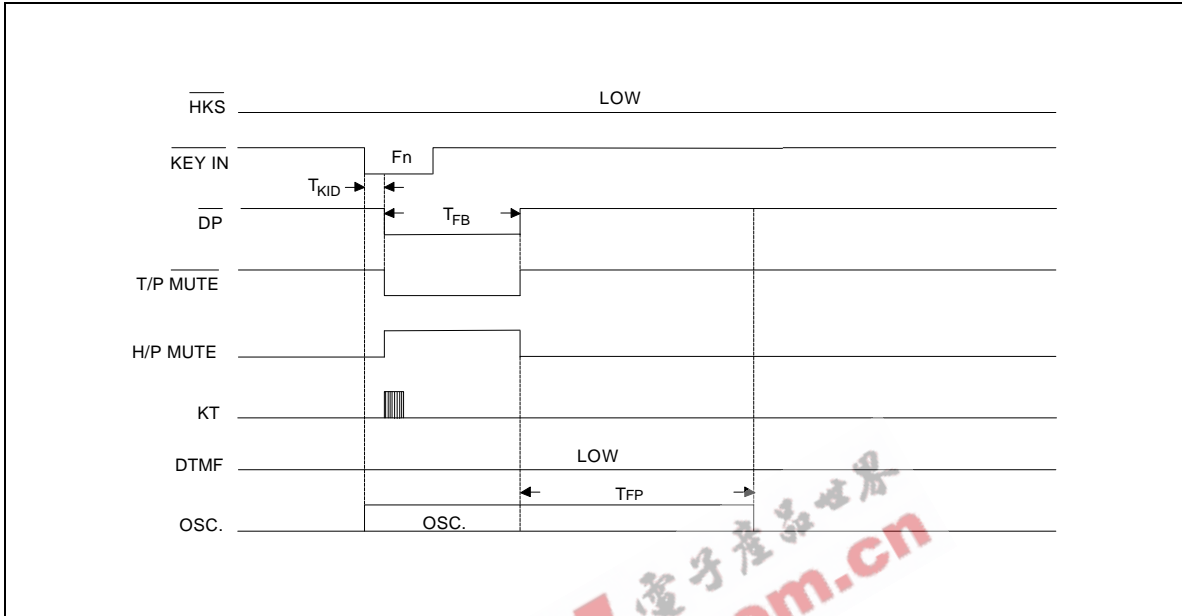

Figure 8 Flash Operation Timing Diagram

EEPW.com.cn 电子产品世界

W91810N SERIES



PAD LIST

PAD NO.	PAD NAME	PIN NAME	X	Y	PAD NO.	PAD NAME	PIN NAME	X	Y
1	COL 1	1	-441.50	987.80	17	VOL<2>	15	172.70	-1008.00
2	COL 2	2	-606.50	987.80	18	HF0	16	355.20	-1008.00
3	COL 3	3	-787.00	987.80	19	HKSB	17	520.20	-1008.00
4	COL 4	4	-952.00	987.80	20	DPS	18	702.80	-1008.00
5	COL 5	5	-928.00	703.60	21	DTMF	19	914.60	-1027.60
6	COL 6	6	-928.00	538.60	22	MODE	20	942.60	-732.40
7	LOCK		-928.00	345.00	23	VDD	21	942.60	-532.70
8	KT	7	-928.00	180.00	24	KMUTEB	22	961.80	-341.80
9	HPMUTE	8	-928.00	-10.00	25	ROW 1	23	968.40	975.30
10	OPTION		-928.00	-175.00	26	ROW 2	24	790.60	995.80
11	Vss	9	-928.00	-379.20	27	ROW 3	25	610.10	995.80
12	OSCIN	10	-936.00	-880.70	28	ROW 4	26	445.10	995.80
13	OSCOUT	11	-866.50	-1055.20	29	ROW 5	27	264.60	995.80
14	TPMUTE	12	-647.50	-1055.00	30	ROW 6	28	99.60	995.80
15	HF1	13	-456.50	-1055.00					
16	VOT<1>	14	-190.50	-1055.00					

W91810N SERIES



EEPW 电子產品世界
.com.cn



Headquarters

No. 4, Creation Rd. III,
Science-Based Industrial Park,
Hsinchu, Taiwan
TEL: 886-3-5770066
FAX: 886-3-5792766
<http://www.winbond.com.tw/>
Voice & Fax-on-demand: 886-2-27197006

Taipei Office

11F, No. 115, Sec. 3, Min-Sheng East Rd.,
Taipei, Taiwan
TEL: 886-2-27190505
FAX: 886-2-27197502

Winbond Electronics (H.K.) Ltd.

Rm. 803, World Trade Square, Tower II,
123 Hoi Bun Rd., Kwun Tong,
Kowloon, Hong Kong
TEL: 852-27513100
FAX: 852-27552064

Winbond Electronics North America Corp.

Winbond Memory Lab.
Winbond Microelectronics Corp.
Winbond Systems Lab.
2727 N. First Street, San Jose,
CA 95134, U.S.A.
TEL: 408-9436666
FAX: 408-5441798

Note: All data and specifications are subject to change without notice.

TYPICAL APPLICATION CIRCUIT

