

## 128Kx32 5V FLASH MODULE, SMD 5962-94716

### FEATURES

- Access Times of 50\*\*, 60, 70, 90, 120, 150ns
- Packaging:
  - 66 pin, PGA Type, 1.075 inch square, Hermetic Ceramic HIP (Package 400)
  - 68 lead, Hermetic CQFP (G2U), 22.4mm (0.880 inch) square, 3.56mm (0.140 inch) high (Package 510)
  - 68 lead, Hermetic CQFP (G2L), 22.4mm (0.880 inch) square, 4.06mm (0.160 inch) high (Package 528)
- Sector Architecture
  - 8 equal size sectors of 16KBytes each
  - Any combination of sectors can be concurrently erased. Also supports full chip erase
- 100,000 Erase/Program Cycles Typical, 0°C to +70°C
- Organized as 128Kx32
- Commercial, Industrial and Military Temperature Ranges
- 5 Volt Programming. 5V ± 10% Supply
- Low Power CMOS, 1mA Standby Typical
- Embedded Erase and Program Algorithms
- TTL Compatible Inputs and CMOS Outputs
- Built-in Decoupling Caps and Multiple Ground Pins for Low Noise Operation
- Page Program Operation and Internal Program Control Time
- Weight
  - WF128K32-XG2LX5 - 8 grams typical
  - WF128K32-XG2UX5 - 8 grams typical
  - WF128K32-XH1X5 - 13 grams typical

Note: For programming information refer to Flash Programming 1M5 Application Note.

\* This product is subject to change without notice.

\*\* The access time of 50ns is available in Industrial and Commercial temperature ranges only.

**FIGURE 1 – PIN CONFIGURATION FOR WF128K32N-XH1X5**

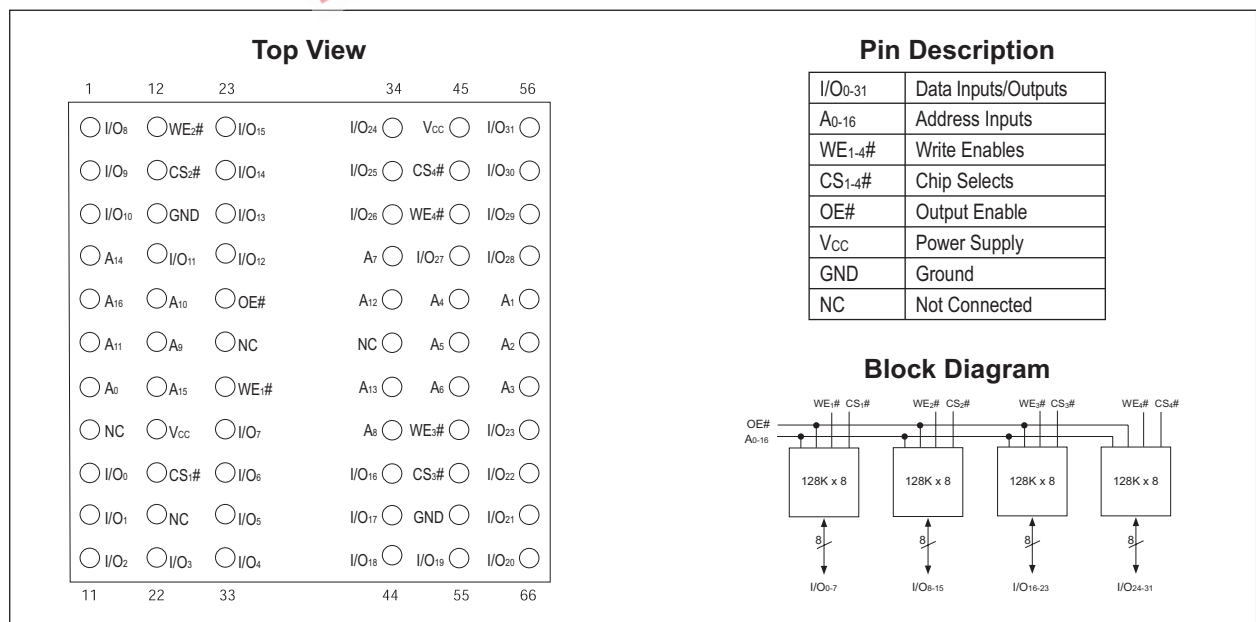

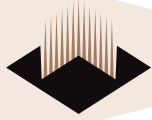

**FIGURE 3 – PIN CONFIGURATION FOR WF128K32-XG2UX5 AND WF128K32-XG2LX5**

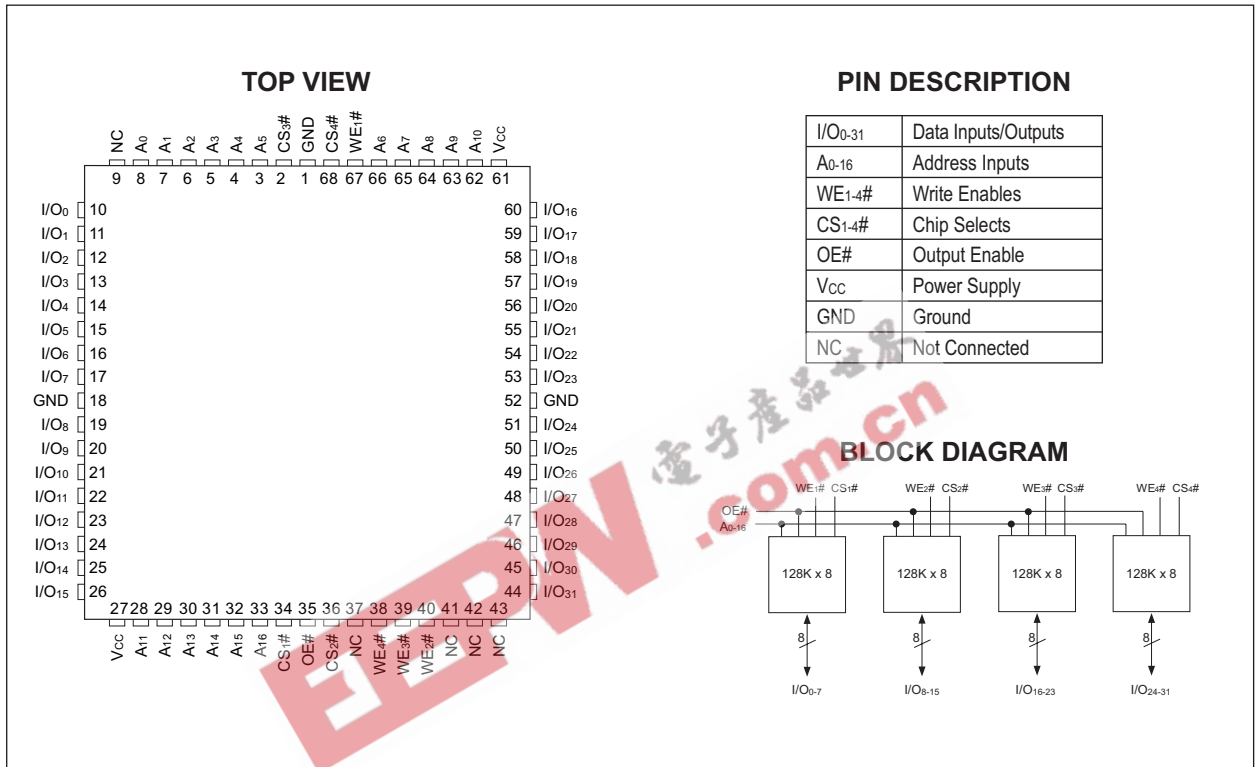

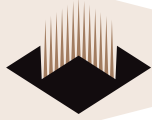

**ABSOLUTE MAXIMUM RATINGS (1)**

Parameter		Unit
Operating Temperature	-55 to +125	°C
Supply Voltage Range (V <sub>CC</sub> )	-2.0 to +7.0	V
Signal voltage range (any pin except A9) (2)	-2.0 to +7.0	V
Storage Temperature Range	-65 to +150	°C
Lead Temperature (soldering, 10 seconds)	+300	°C
Data Retention Mil Temp	10 years	
Endurance (write/erase cycles) Mil Temp	10,000 cycles min.	
A9 Voltage for sector protect (V <sub>ID</sub> ) (3)	-2.0 to +14.0	V

NOTES:

- Stresses above the absolute maximum rating may cause permanent damage to the device. Extended operation at the maximum levels may degrade performance and affect reliability.
- Minimum DC voltage on input or I/O pins is -0.5V. During voltage transitions, inputs may overshoot V<sub>SS</sub> to -2.0 V for periods of up to 20ns. Maximum DC voltage on output and I/O pins is V<sub>CC</sub> + 0.5V. During voltage transitions, outputs may overshoot to V<sub>CC</sub> + 2.0 V for periods of up to 20ns.
- Minimum DC input voltage on A9 pin is -0.5V. During voltage transitions, A9 may overshoot V<sub>SS</sub> to -2V for periods of up to 20ns. Maximum DC input voltage on A9 is +13.5V which may overshoot to 14.0 V for periods up to 20ns.

**RECOMMENDED OPERATING CONDITIONS**

Parameter	Symbol	Min	Max	Unit
Supply Voltage	V <sub>CC</sub>	4.5	5.5	V
Input High Voltage	V <sub>IH</sub>	2.0	V <sub>CC</sub> + 0.3	V
Input Low Voltage	V <sub>IL</sub>	-0.5	+0.8	V
Operating Temp. (Mil.)	T <sub>A</sub>	-55	+125	°C
A9 Voltage for Sector Protect	V <sub>ID</sub>	11.5	12.5	V

**CAPACITANCE**

T<sub>a</sub> = +25°C

Parameter	Symbol	Conditions	Max	Unit
OE# capacitance	C <sub>OE</sub>	V <sub>IN</sub> = 0V, f = 1.0 MHz	50	pF
WE1-4# capacitance	C <sub>WE</sub>	V <sub>IN</sub> = 0V, f = 1.0 MHz		pF
HIP (PGA) H1			20	
CQFP G2U/G2L			15	
CS1-4# capacitance	C <sub>CS</sub>	V <sub>IN</sub> = 0V, f = 1.0 MHz	20	pF
Data# I/O capacitance	C <sub>I/O</sub>	V <sub>I/O</sub> = 0V, f = 1.0 MHz	20	pF
Address input capacitance	C <sub>AD</sub>	V <sub>IN</sub> = 0V, f = 1.0 MHz	50	pF

This parameter is guaranteed by design but not tested.

**DC CHARACTERISTICS – CMOS COMPATIBLE**

V<sub>CC</sub> = 5.0V, V<sub>SS</sub> = 0V, -55°C ≤ T<sub>A</sub> ≤ +125°C

Parameter	Symbol	Conditions	Min	Max	Unit
Input Leakage Current	I <sub>LI</sub>	V <sub>CC</sub> = 5.5, V <sub>IN</sub> = GND to V <sub>CC</sub>		10	μA
Output Leakage Current	I <sub>LOx32</sub>	V <sub>CC</sub> = 5.5, V <sub>IN</sub> = GND to V <sub>CC</sub>		10	μA
V <sub>CC</sub> Active Current for Read (1)	I <sub>CC1</sub>	CS# = V <sub>IL</sub> , OE# = V <sub>IH</sub>		140	mA
V <sub>CC</sub> Active Current for Program or Erase (2)	I <sub>CC2</sub>	CS# = V <sub>IL</sub> , OE# = V <sub>IH</sub>		200	mA
V <sub>CC</sub> Standby Current	I <sub>CC3</sub>	V <sub>CC</sub> = 5.5, CS# = V <sub>IH</sub> , f = 5MHz		6.5	mA
V <sub>CC</sub> Static Current	I <sub>CC4</sub>	V <sub>CC</sub> = 5.5, CS# = V <sub>IH</sub>		0.6	mA
Output Low Voltage	V <sub>OL</sub>	I <sub>OL</sub> = 8.0 mA, V <sub>CC</sub> = 4.5		0.45	V
Output High Voltage	V <sub>OH1</sub>	I <sub>OH</sub> = -2.5 mA, V <sub>CC</sub> = 4.5	0.85 x V <sub>CC</sub>		V
Output High Voltage	V <sub>OH2</sub>	I <sub>OH</sub> = -100 μA, V <sub>CC</sub> = 4.5	V <sub>CC</sub> - 0.4		V
Low V <sub>CC</sub> Lock Out Voltage	V <sub>LKO</sub>		3.2		V

NOTES:

- The I<sub>CC</sub> current listed includes both the DC operating current and the frequency dependent component (at 5 MHz).  
The frequency component typically is less than 2 mA/MHz, with OE# at V<sub>IH</sub>.
- I<sub>CC</sub> active while Embedded Algorithm (program or erase) is in progress.
- DC test conditions: V<sub>IL</sub> = 0.3V, V<sub>IH</sub> = V<sub>CC</sub> - 0.3V

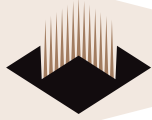

**AC CHARACTERISTICS – WRITE/ERASE/PROGRAM OPERATIONS, CS# CONTROLLED**

V<sub>CC</sub> = 5.0V, V<sub>SS</sub> = 0V, -55°C ≤ T<sub>A</sub> ≤ +125°C

Parameter	Symbol		-50		-60		-70		-90		-120		-150		Unit
	Min	Max	Min	Max	Min	Max	Min	Max	Min	Max	Min	Max	Min	Max	
Write Cycle Time	t <sub>AVAV</sub>	t <sub>WC</sub>	50		60		70		90		120		150		ns
WE# Setup Time	t <sub>WLEL</sub>	t <sub>WS</sub>	0		0		0		0		0		0		ns
CS# Pulse Width	t <sub>LELH</sub>	t <sub>CP</sub>	25		30		35		45		50		50		ns
Address Setup Time	t <sub>AVEL</sub>	t <sub>AS</sub>	0		0		0		0		0		0		ns
Data Setup Time	t <sub>DVEH</sub>	t <sub>DS</sub>	25		30		30		45		50		50		ns
Data Hold Time	t <sub>EHDX</sub>	t <sub>DH</sub>	0		0		0		0		0		0		ns
Address Hold Time	t <sub>ELAX</sub>	t <sub>AH</sub>	40		45		45		45		50		50		ns
WE# Hold from WE# High	t <sub>EHWH</sub>	t <sub>WH</sub>	0		0		0		0		0		0		ns
CS# Pulse Width High	t <sub>EHEL</sub>	t <sub>CPH</sub>	20		20		20		20		20		20		ns
Duration of Programming Operation	t <sub>WHWH1</sub>		14		14		14		14		14		14		μs
Duration of Erase Operation	t <sub>WHWH2</sub>		2.2	60	2.2	60	2.2	60	2.2	60	2.2	60	2.2	60	sec
Read Recovery before Write	t <sub>GHLEL</sub>		0		0		0		0		0		0		ns
Chip Programming Time				12.5		12.5		12.5		12.5		12.5		12.5	sec

FIGURE 4 – AC TEST CIRCUIT

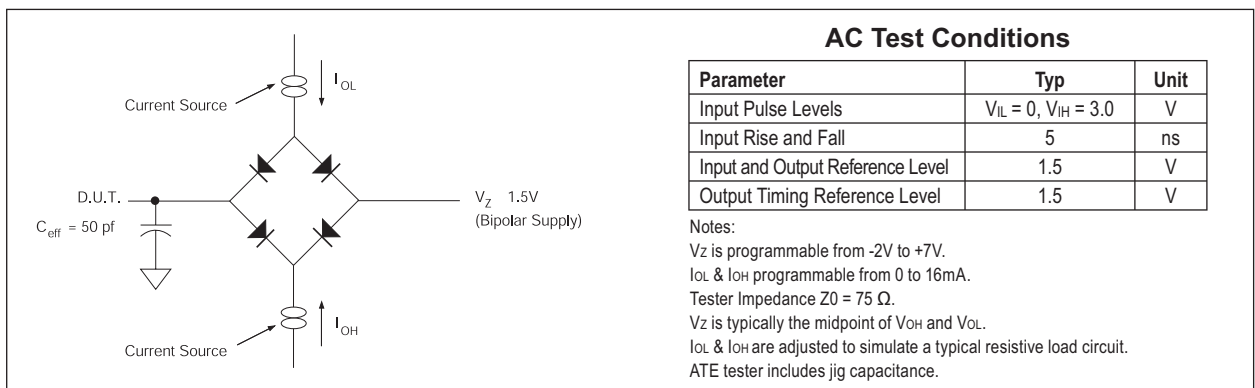

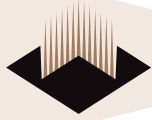

**AC CHARACTERISTICS – WRITE/ERASE/PROGRAM OPERATIONS, WE# CONTROLLED**

V<sub>CC</sub> = 5.0V, V<sub>SS</sub> = 0V, -55°C ≤ T<sub>A</sub> ≤ +125°C

Parameter	Symbol		-50		-60		-70		-90		-120		-150		Unit
			Min	Max	Min	Max	Min	Max	Min	Max	Min	Max	Min	Max	
Write Cycle Time	t <sub>AVAV</sub>	t <sub>WC</sub>	50		60		70		90		120		150		ns
Chip Select Setup Time	t <sub>ELWL</sub>	t <sub>CS</sub>	0		0		0		0		0		0		ns
Write Enable Pulse Width	t <sub>WLWH</sub>	t <sub>WP</sub>	25		30		35		45		50		50		ns
Address Setup Time	t <sub>AVWL</sub>	t <sub>AS</sub>	0		0		0		0		0		0		ns
Data Setup Time	t <sub>DVWH</sub>	t <sub>DS</sub>	25		30		30		45		50		50		ns
Data Hold Time	t <sub>WHDX</sub>	t <sub>DH</sub>	0		0		0		0		0		0		ns
Address Hold Time	t <sub>WLAX</sub>	t <sub>AH</sub>	40		45		45		45		50		50		ns
Chip Select Hold Time	t <sub>WHEH</sub>	t <sub>CH</sub>	0		0		0		0		0		0		ns
Write Enable Pulse Width High	t <sub>WHWL</sub>	t <sub>WPH</sub>	20		20		20		20		20		20		ns
Duration of Byte Programming Operation (min)	t <sub>WHWH1</sub>		14		14		14		14		14		14		μs
Sector Erase Time	t <sub>WHWH2</sub>		2.2	60	2.2	60	2.2	60	2.2	60	2.2	60	2.2	60	sec
Read Recovery Time Before Write	t <sub>GHWL</sub>		0		0		0		0		0		0		ns
V <sub>CC</sub> Setup Time		t <sub>VCS</sub>	50		50		50		50		50		50		μs
Chip Programming Time				12.5		12.5		12.5		12.5		12.5		12.5	sec
Output Enable Setup Time		t <sub>OES</sub>	0		0		0		0		0		0		ns
Output Enable Hold Time (1)		t <sub>OEH</sub>	10		10		10		10		10		10		ns

1. For Toggle and Data Polling.

**AC CHARACTERISTICS – READ ONLY OPERATIONS**

V<sub>CC</sub> = 5.0V, V<sub>SS</sub> = 0V, -55°C ≤ T<sub>A</sub> ≤ +125°C

Parameter	Symbol		-50		-60		-70		-90		-120		-150		Unit
			Min	Max	Min	Max	Min	Max	Min	Max	Min	Max	Min	Max	
Read Cycle Time	t <sub>AVAV</sub>	t <sub>RC</sub>	50		60		70		90		120		150		ns
Address Access Time	t <sub>AVQV</sub>	t <sub>ACC</sub>		50		60		70		90		120		150	ns
Chip Select Access Time	t <sub>ELQV</sub>	t <sub>CE</sub>		50		60		70		90		120		150	ns
OE# to Output Valid	t <sub>GLQV</sub>	t <sub>OE</sub>		25		30		35		40		50		55	ns
Chip Select to Output High Z (1)	t <sub>EHQZ</sub>	t <sub>DF</sub>		20		20		20		25		30		35	ns
OE# High to Output High Z (1)	t <sub>GHQZ</sub>	t <sub>DF</sub>		20		20		20		25		30		35	ns
Output Hold from Address, CS# or OE# Change, whichever is first	t <sub>AXQX</sub>	t <sub>OH</sub>	0		0		0		0		0		0		ns

1. Guaranteed by design, not tested.

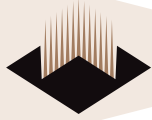

**FIGURE 5 – AC WAVEFORMS FOR READ OPERATIONS**

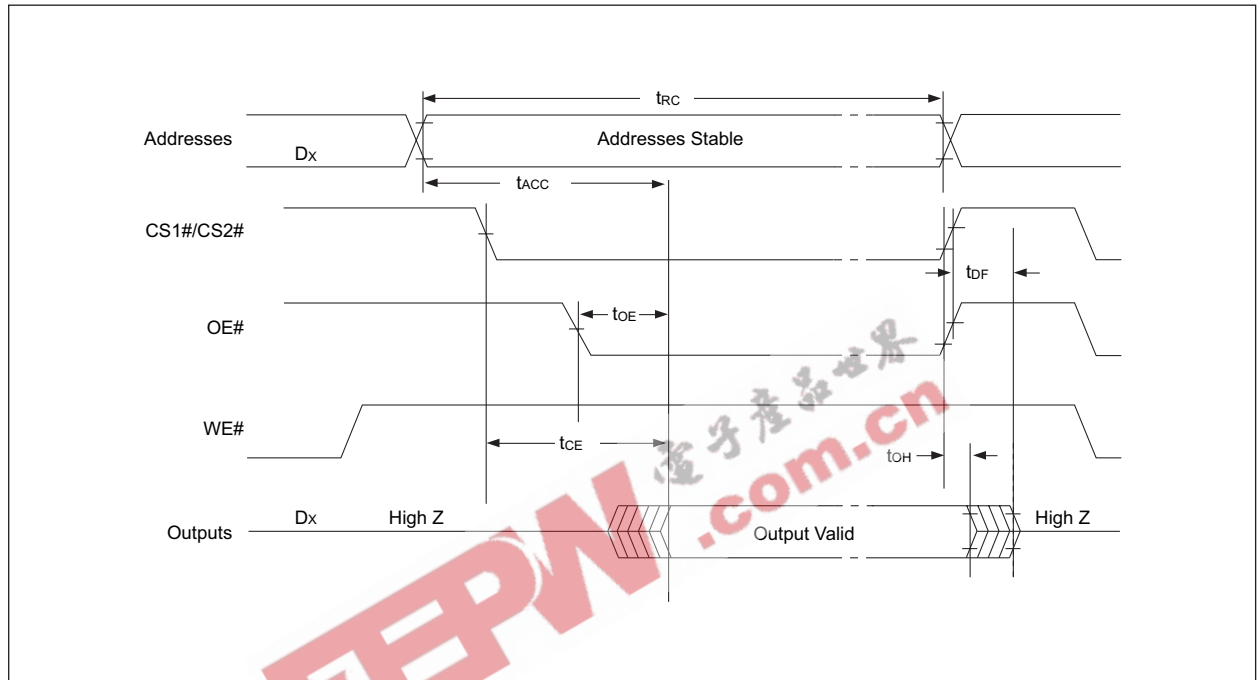

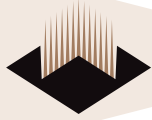
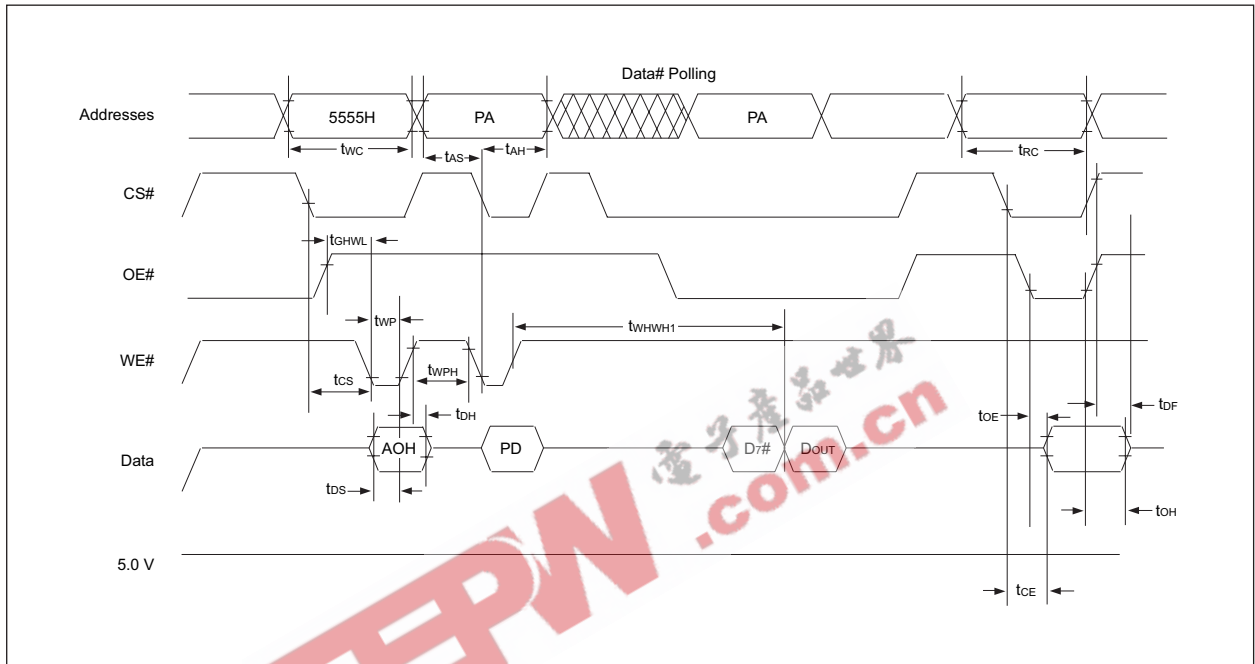

FIGURE 6 – WRITE/ERASE/PROGRAM OPERATION, WE# CONTROLLED



NOTES:

1. PA is the address of the memory location to be programmed.
2. PD is the data to be programmed at byte address.
3. D7# is the output of the complement of the data written to the device (for each chip).
4. DOUT is the output of the data written to the device.
5. Figure indicates last two bus cycles of four bus cycle sequence.

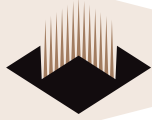
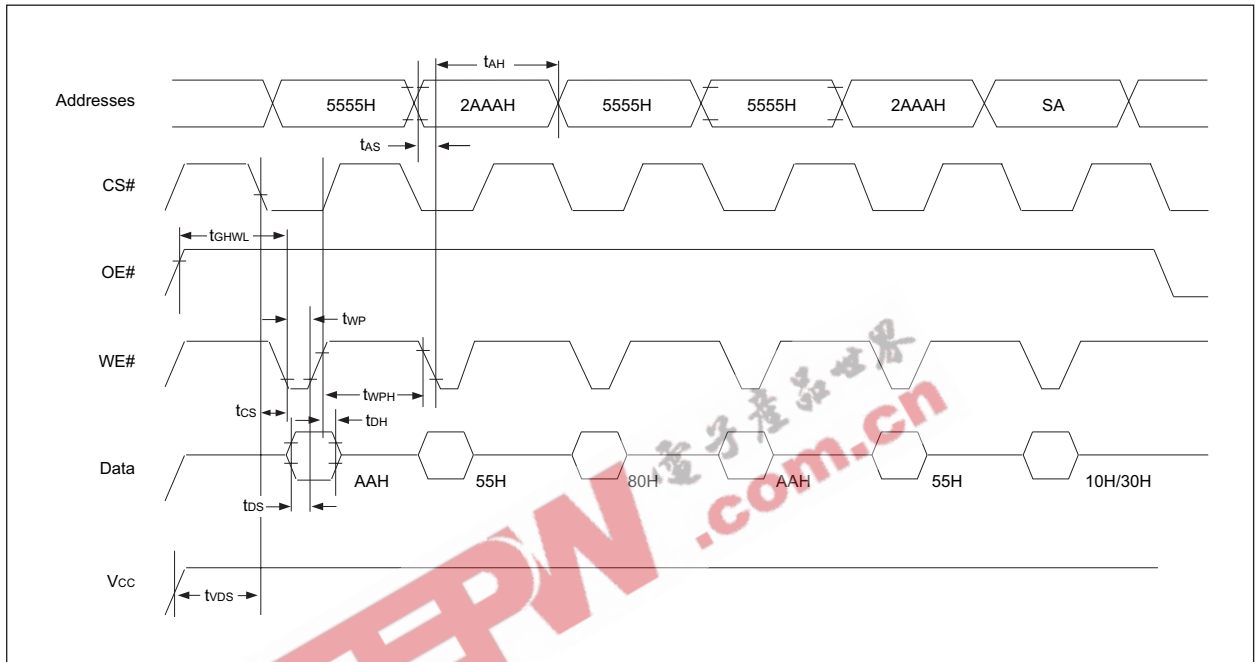

FIGURE 7 – AC WAVEFORMS CHIP/SECTOR ERASE OPERATIONS



Notes:

1. SA is the sector address for Sector Erase.



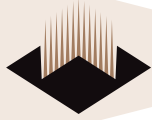
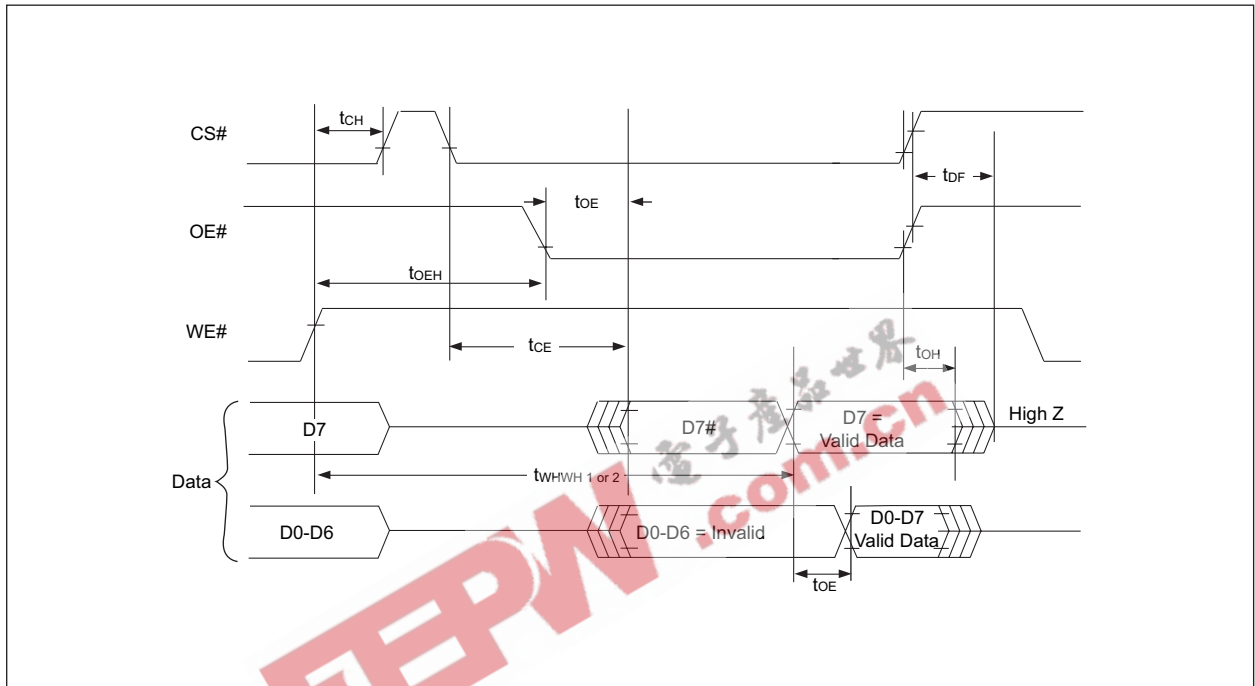

FIGURE 8 – AC WAVEFORMS FOR DATA# POLLING DURING EMBEDDED ALGORITHM OPERATIONS



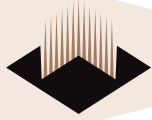
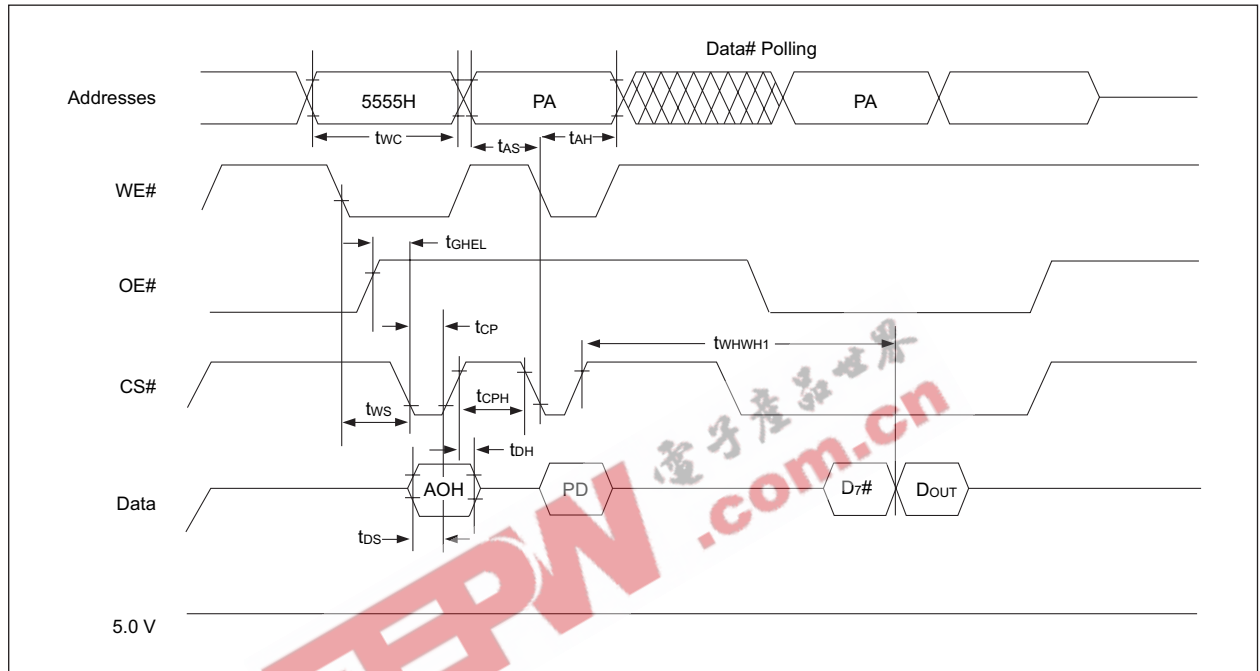
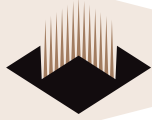

FIGURE 9 – WRITE/ERASE/PROGRAM OPERATION, CS# CONTROLLED



NOTES:

1. PA represents the address of the memory location to be programmed.
2. PD represents the data to be programmed at byte address.
3. D7# is the output of the complement of the data written to the device (for each chip).
4. DOUT is the output of the data written to the device.
5. Figure indicates the last two bus cycles of a four bus cycle sequence.



**PACKAGE 400: 66 PIN, PGA TYPE, CERAMIC HEX-IN-LINE PACKAGE, HIP (H1)**

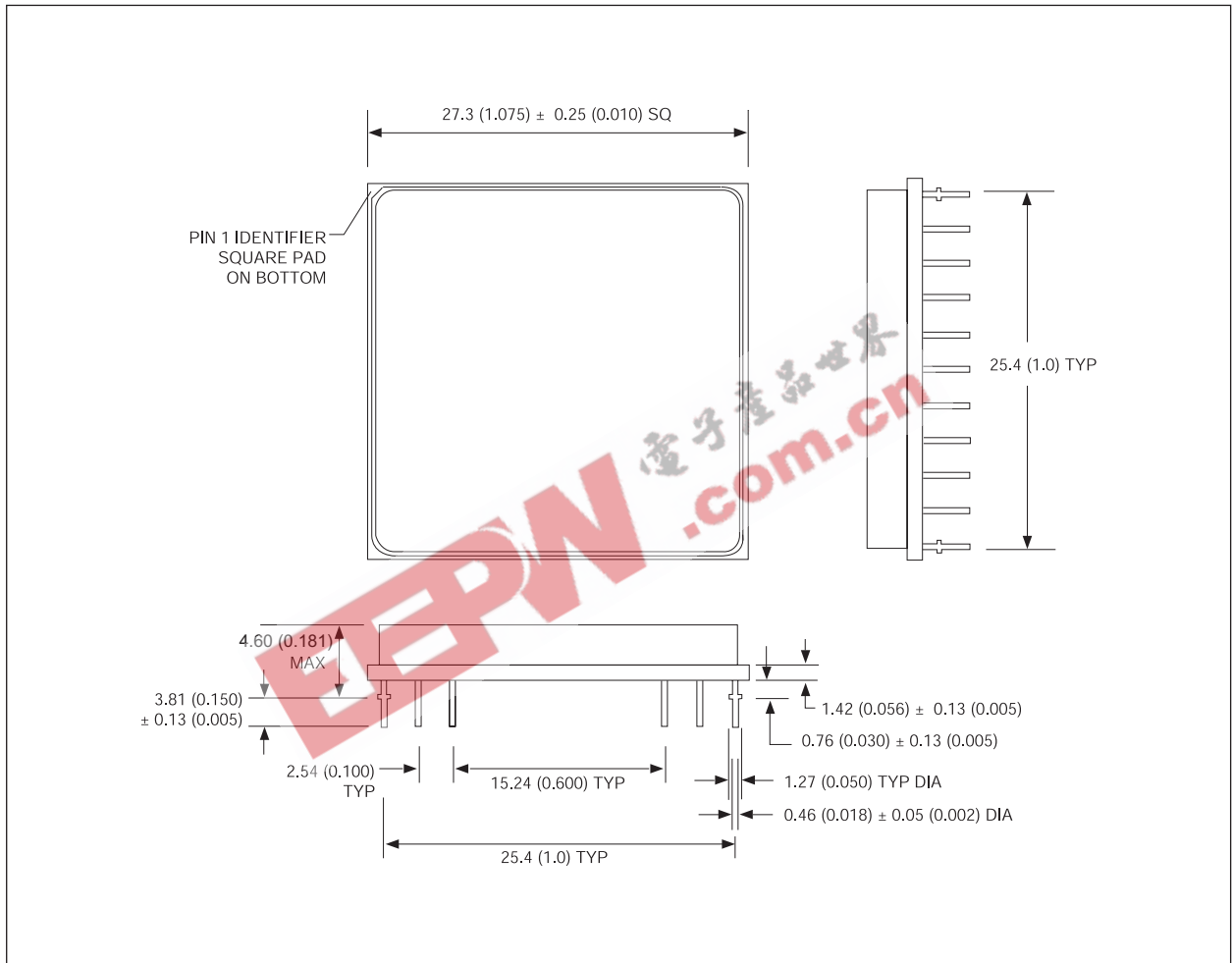

ALL LINEAR DIMENSIONS ARE MILLIMETERS AND PARENTHETICALLY IN INCHES

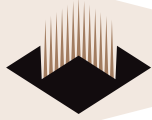

PACKAGE 510: 68 LEAD, CERAMIC QUAD FLAT PACK, CQFP (G2U)

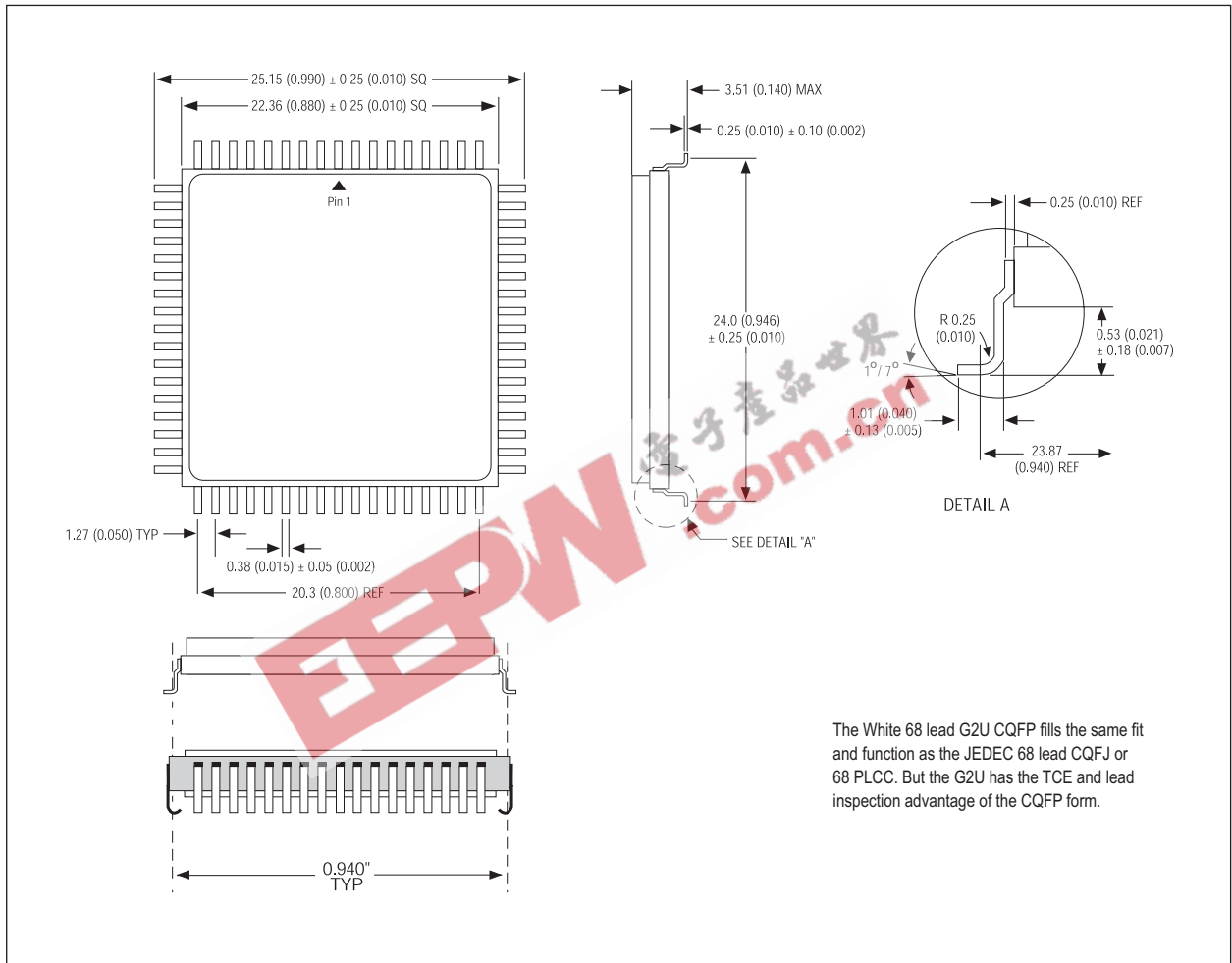

The White 68 lead G2U CQFP fills the same fit and function as the JEDEC 68 lead CQFJ or 68 PLCC. But the G2U has the TCE and lead inspection advantage of the CQFP form.

ALL LINEAR DIMENSIONS ARE MILLIMETERS AND PARENTHETICALLY IN INCHES

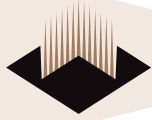

**PACKAGE 528 : 68 LEAD, CERAMIC QUAD FLAT PACK, CQFP (G2L)**

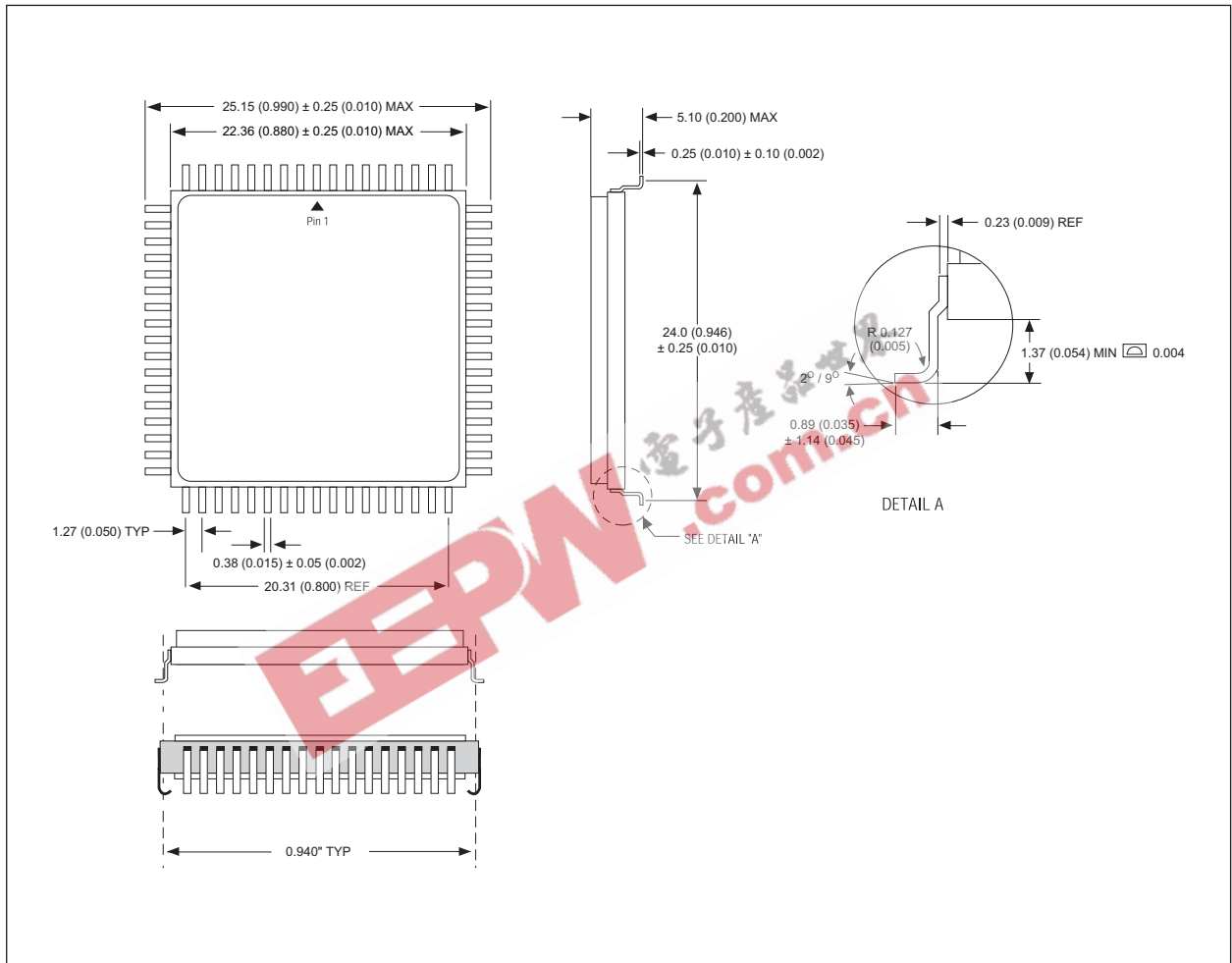

ALL LINEAR DIMENSIONS ARE MILLIMETERS AND PARENTHETICALLY IN INCHES

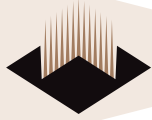

**ORDERING INFORMATION**

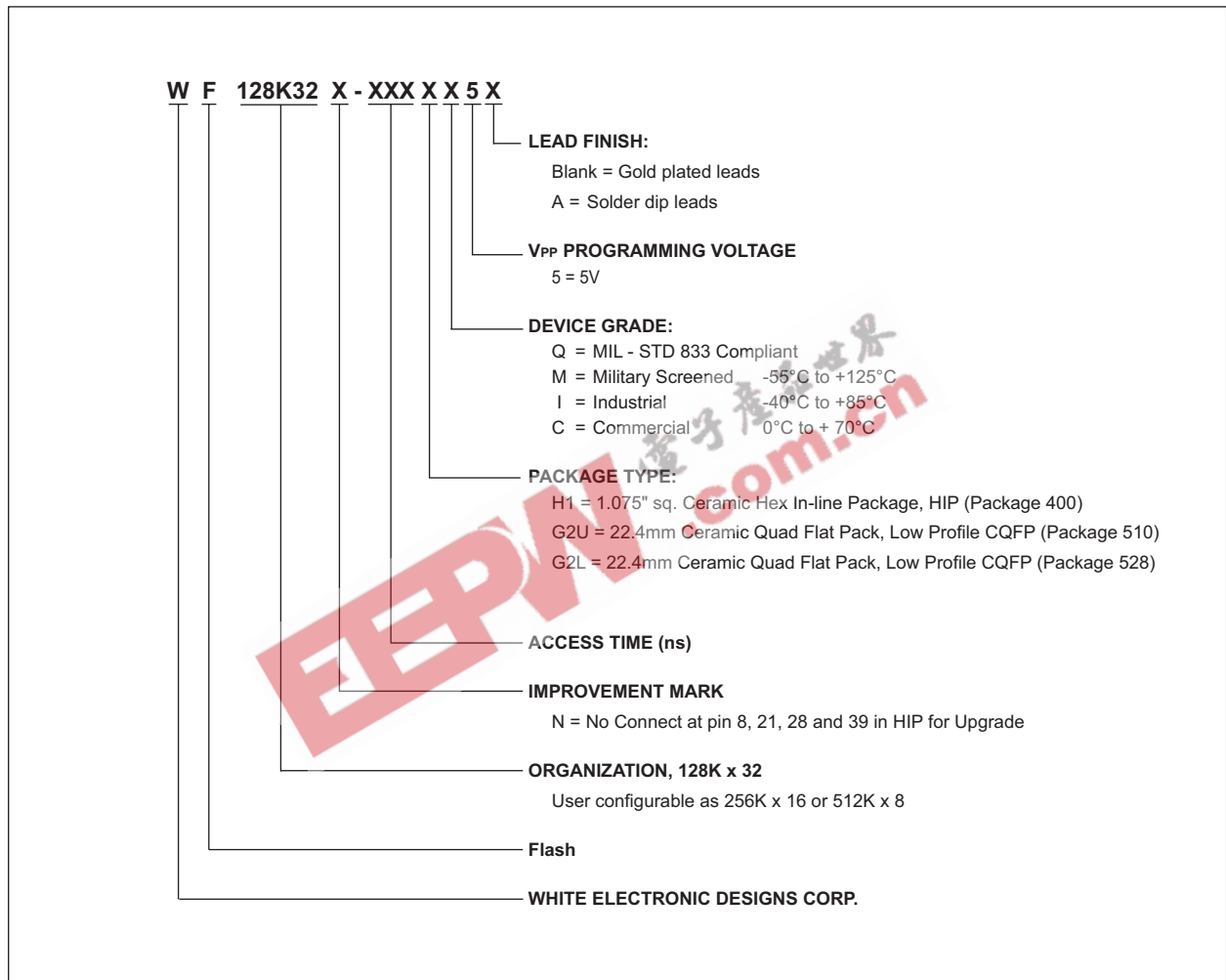

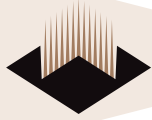

DEVICE TYPE	SPEED	PACKAGE	SMD NO.
128K x 32 Flash	150ns	66 pin HIP (H1)	5962-94716 01H8X
128K x 32 Flash	120ns	66 pin HIP (H1)	5962-94716 02H8X
128K x 32 Flash	90ns	66 pin HIP (H1)	5962-94716 03H8X
128K x 32 Flash	70ns	66 pin HIP (H1)	5962-94716 04H8X
128K x 32 Flash	60ns	66 pin HIP (H1)	5962-94716 05H8X
128K x 32 Flash	150ns	68 lead CQFP (G2U)	5962-94716 01HNX
128K x 32 Flash	120ns	68 lead CQFP (G2U)	5962-94716 02HNX
128K x 32 Flash	90ns	68 lead CQFP (G2U)	5962-94716 03HNX
128K x 32 Flash	70ns	68 lead CQFP (G2U)	5962-94716 04HNX
128K x 32 Flash	60ns	68 lead CQFP (G2U)	5962-94716 05HNX
128K x 32 Flash	150ns	68 lead CQFP (G2L)	5962-94716 01HAX
128K x 32 Flash	120ns	68 lead CQFP (G2L)	5962-94716 02HAX
128K x 32 Flash	90ns	68 lead CQFP (G2L)	5962-94716 03HAX
128K x 32 Flash	70ns	68 lead CQFP (G2L)	5962-94716 04HAX
128K x 32 Flash	60ns	68 lead CQFP (G2L)	5962-94716 05HAX

Note 1: Package Not Recommended For New Design