

# Frequency Controller with System Recovery for Intel<sup>®</sup> Integrated Core Logic

## Features

- Single chip FTG solution for Intel Solano/810E/810
- Programmable clock output frequency with less than 1 MHz increment
- Integrated fail-safe Watchdog timer for system recovery
- Automatically switch to HW selected or SW programmed clock frequency when Watchdog timer time-out
- Capable of generating system RESET after a Watchdog timer time-out occurs or a change in output frequency via SMBus interface
- Support SMBus byte read/write and block read/write operations to simplify system BIOS development
- Vendor ID and Revision ID support
- Programmable drive strength for SDRAM and PCI output clocks
- Programmable output skew between CPU, AGP, PCI and SDRAM
- Maximized EMI suppression using Cypress's Spread Spectrum Technology
- Low jitter and tightly controlled clock skew
- Two copies of CPU clock

- Thirteen copies of SDRAM clock
- Eight copies of PCI clock
- One copy of synchronous APIC clock
- Three copies of 66-MHz outputs
- Three copies of 48-MHz outputs
- One copy of double strength 14.31818-MHz reference clock
- One RESET output for system recovery
- SMBus interface for turning off unused clocks

## Key Specifications

CPU, SDRAM Outputs Cycle-to-Cycle Jitter: .....	250 ps
APIC, 48-MHz, 3V66, PCI Outputs Cycle-to-Cycle Jitter: .....	500 ps
CPU, 3V66 Output Skew: .....	175 ps
SDRAM, APIC, 48-MHz Output Skew: .....	250 ps
PCI Output Skew: .....	500 ps
CPU to SDRAM Skew (@ 133 MHz) .....	± 0.5 ns
CPU to SDRAM Skew (@ 100 MHz) .....	4.5 to 5.5 ns
CPU to 3V66 Skew (@ 66 MHz) .....	7.0 to 8.0 ns
3V66 to PCI Skew (3V66 lead) .....	1.5 to 3.5 ns
PCI to APIC Skew .....	± 0.5 ns

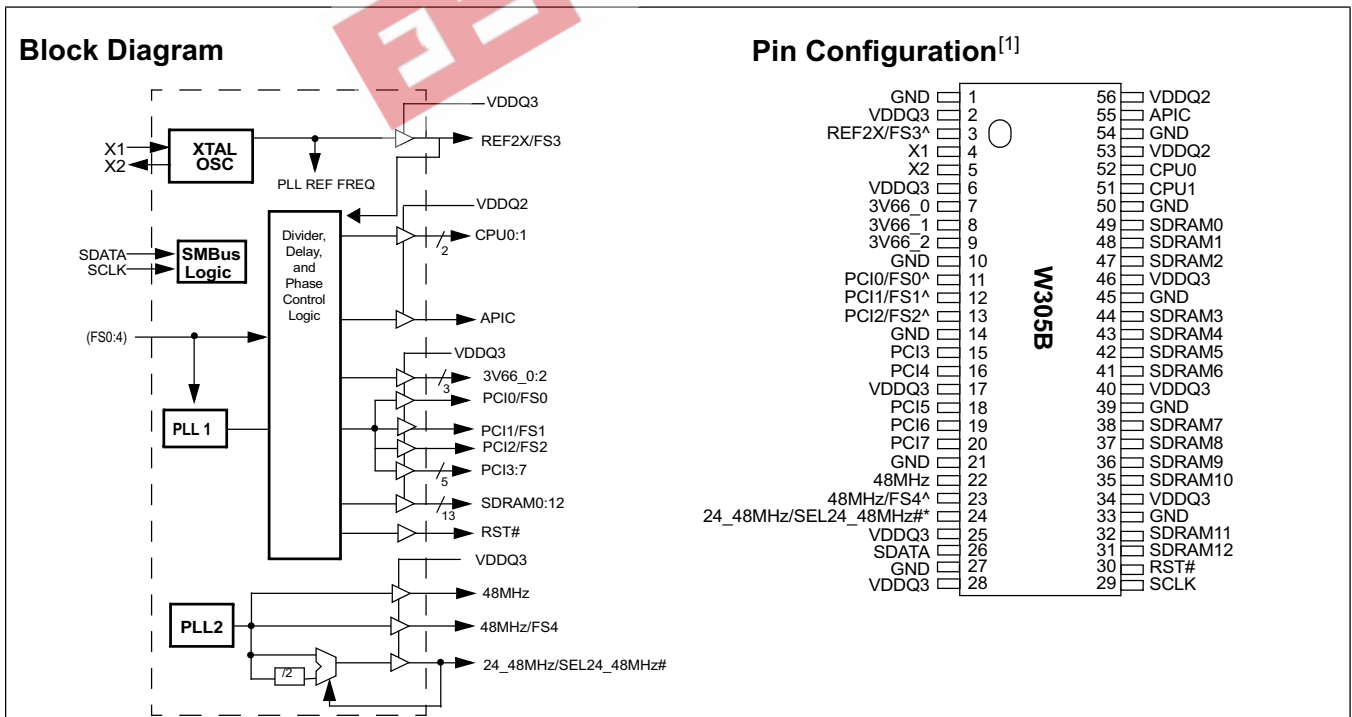

1. Internal 100K pull-up and 100K pull-down resistors present on inputs marked with \* and ^ respectively. Design should not rely solely on internal pull-up resistor to set I/O pins HIGH or LOW.

**Pin Definitions**

Pin Name	Pin No.	Pin Type	Pin Description
REF2X/FS3	3	I/O	<b>Reference Clock with 2x Drive/Frequency Select 3.</b> 3.3V 14.318-MHz clock output. This pin also serves as the select strap to determine device operating frequency as described in <i>Table 5</i> .
X1	4	I	<b>Crystal Input.</b> This pin has dual functions. It can be used as an external 14.318-MHz crystal connection or as an external reference frequency input.
X2	5	O	<b>Crystal Output.</b> An input connection for an external 14.318-MHz crystal connection. If using an external reference, this pin must be left unconnected.
PCI0/FS0	11	I/O	<b>PCI Clock 0/Frequency Selection 0.</b> 3.3V 33-MHz PCI clock outputs. This pin also serves as the select strap to determine device operating frequency as described in <i>Table 5</i> .
PCI1/FS1	12	I/O	<b>PCI Clock 1/Frequency Selection 1.</b> 3.3V 33-MHz PCI clock outputs. This pin also serves as the select strap to determine device operating frequency as described in <i>Table 5</i> .
PCI2/FS2	13	I/O	<b>PCI Clock 2/Frequency Selection 2.</b> 3.3V 33-MHz PCI clock outputs. This pin also serves as the select strap to determine device operating frequency as described in <i>Table 5</i> .
PCI3:7	15, 16, 18, 19, 20	O	<b>PCI Clock 3 through 7.</b> 3.3V 33-MHz PCI clock outputs. PCI0:7 can be individually turned off via SMBus interface.
3V66_0:2	7, 8, 9	O	<b>66-MHz Clock Output.</b> 3.3V output clocks. The operating frequency is controlled by FS0:4 (see <i>Table 5</i> ).
48MHz	22	O	<b>48MHz.</b> 3.3V 48-MHz non-spread spectrum output.
48MHz/FS4	23	I/O	<b>48-MHz Output/Frequency Selection 4.</b> 3.3V 48-MHz non-spread spectrum output. This pin also serves as the select strap to determine device operating frequency as described in <i>Table 5</i> .
24_48MHz/SEL24_48MHz#	24	I/O	<b>24- or 48-MHz Output/Select 24 or 48MHz.</b> 3.3V 24 or 48-MHz non-spread spectrum output. This pin also serves as the select strap to determine the output frequency for 24_48MHz output.
RST#	30	O (open-drain)	<b>Reset#.</b> Open-drain RESET# output.
CPU0:1	52, 51	O	<b>CPU Clock Outputs.</b> Clock outputs for the host bus interface. Output frequencies depending on the configuration of FS0:4. Voltage swing is set by VDDQ2.
SDRAM0:12,	49, 48, 47, 44, 43, 42, 41, 38, 37, 36, 35, 32, 31	O	<b>SDRAM Clock Outputs.</b> 3.3V outputs for SDRAM and chipset. The operating frequency is controlled by FS0:4 (see <i>Table 5</i> ).
APIC	55	O	<b>Synchronous APIC Clock Outputs.</b> Clock outputs running synchronous with the PCI clock outputs. Voltage swing set by VDDQ2.
SDATA	26	I/O	<b>Data pin for SMBus circuitry.</b>
SCLK	29	I	<b>Clock pin for SMBus circuitry.</b>
VDDQ3	2, 6, 17, 25, 28, 34, 40, 46	P	<b>3.3V Power Connection.</b> Power supply for SDRAM output buffers, PCI output buffers, reference output buffers and 48-MHz output buffers. Connect to 3.3V.
VDDQ2	53, 56	P	<b>2.5V Power Connection.</b> Power supply for APIC and CPU output buffers. Connect to 2.5V.
GND	1, 10, 14, 21, 27, 33, 39, 45, 50, 54	G	<b>Ground Connections.</b> Connect all ground pins to the common system ground plane.

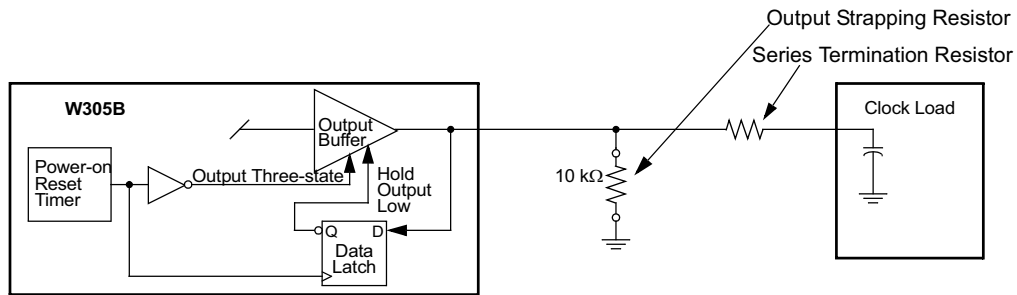

**Figure 1. Input Logic Selection Through Resistor Load Option**

### Overview

The W305B is a highly integrated frequency timing generator, supplying all the required clock sources for an Intel® architecture platform using graphics integrated core logic.

### Functional Description

#### I/O Pin Operation

Upon power-up the power on strap option pins act as a logic input. An external 10-kΩ strapping resistor should be used. *Figure 1* shows a suggested method for strapping resistor connections.

After 2 ms, the pin becomes an output. Assuming the power supply has stabilized by then, the specified output frequency is delivered on the pins. If the power supply has not yet reached full value, output frequency initially may be below target but will increase to target once supply voltage has stabilized. In either case, a short output clock cycle may be produced from the CPU clock outputs when the outputs are enabled.

#### Offsets Among Clock Signal Groups

*Figure 2*, *Figure 3*, and *Figure 4* represent the phase relationship among the different groups of clock outputs from W305B under different frequency modes.

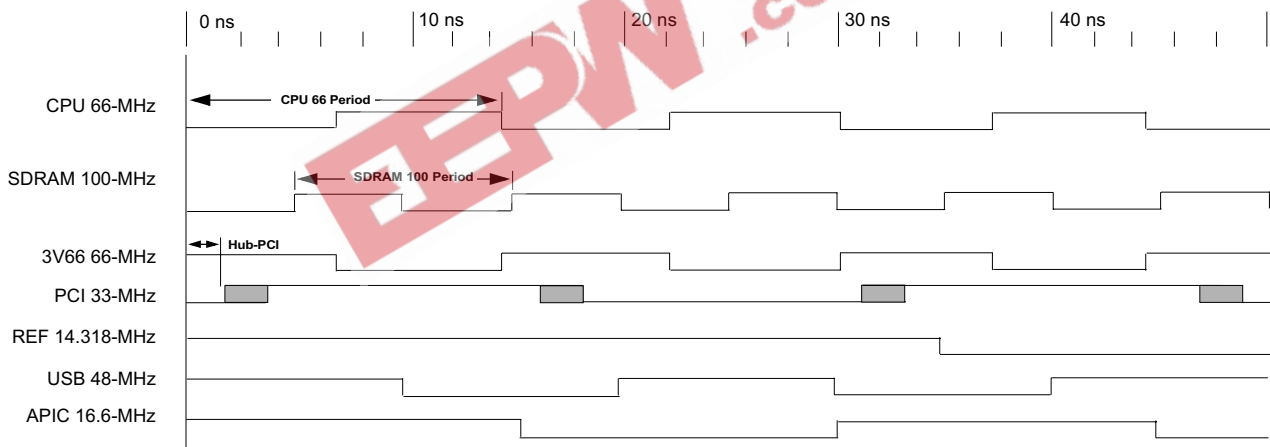

**Figure 2. Group Offset Waveforms (66-MHz CPU Clock, 100-MHz SDRAM Clock)**

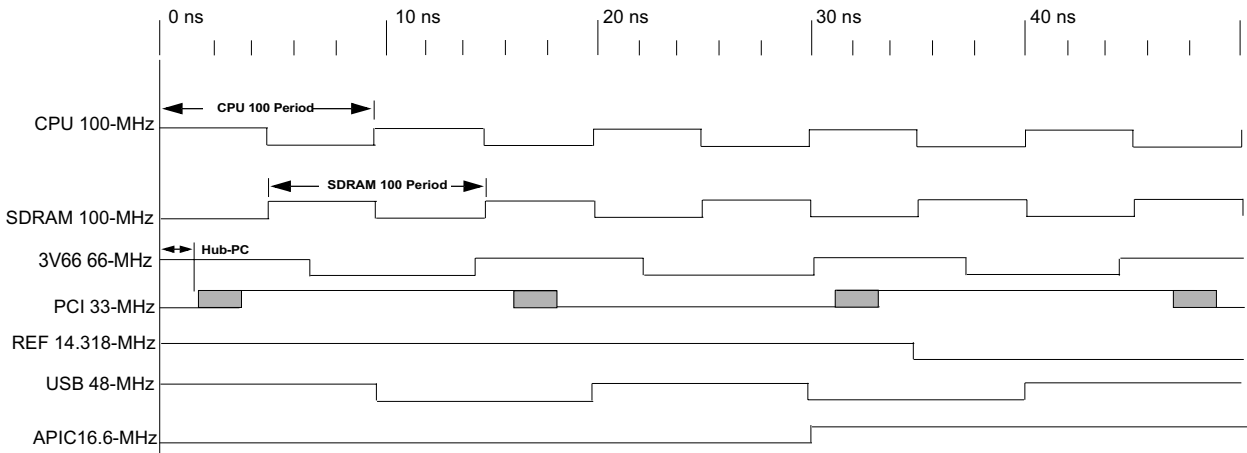

**Figure 3. Group Offset Waveforms (100-MHz CPU Clock, 100-MHz SDRAM Clock)**

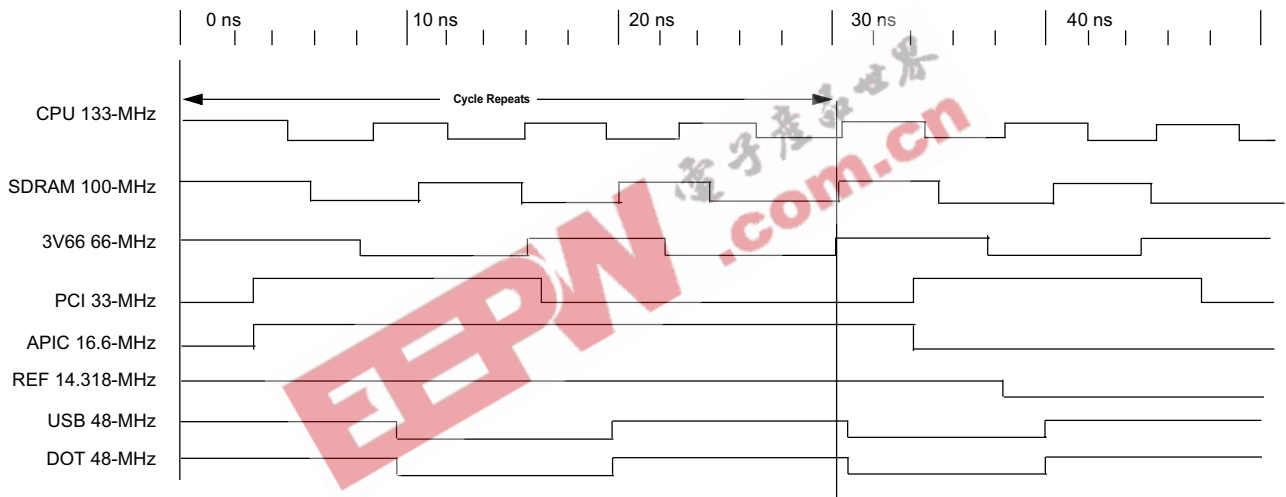

**Figure 4. Group Offset Waveforms (133-MHz CPU/100-MHz SDRAM)**

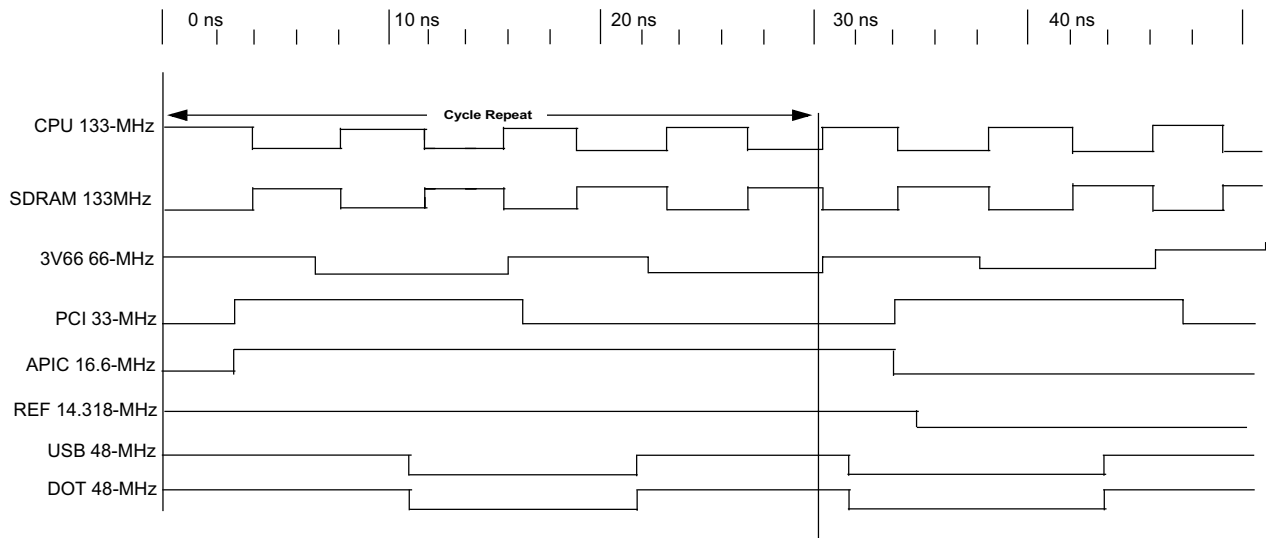

**Figure 5. Group Offset Waveform (133-MHz CPU/133-MHz SDRAM)**

**Serial Data Interface**

The W305B features a two-pin, serial data interface that can be used to configure internal register settings that control particular device functions.

**Data Protocol**

The clock driver serial protocol supports byte/word write, byte/word read, block write and block read operations from the

controller. For block write/read operation, the bytes must be accessed in sequential order from lowest to highest byte with the ability to stop after any complete byte has been transferred. For byte/word write and byte read operations, system controller can access individual indexed byte. The offset of the indexed byte is encoded in the command code.

The definition for the command code is given in *Table 1*.

**Table 1. Command Code Definition**

Bit	Descriptions
7	0 = Block read or block write operation 1 = Byte/Word read or byte/word write operation
6:0	Byte offset for byte/word read or write operation. For block read or write operations, these bits need to be set at '0000000'.

**Table 2. Block Read and Block Write Protocol**

Block Write Protocol		Block Read Protocol	
Bit	Description	Bit	Description
1	Start	1	Start
2:8	Slave address – 7 bit	2:8	Slave address – 7 bit
9	Write	9	Write
10	Acknowledge from slave	10	Acknowledge from slave
11:18	Command Code – 8 bit '00000000' stands for block operation	11:18	Command Code – 8 bit '00000000' stands for block operation
19	Acknowledge from slave	19	Acknowledge from slave
20:27	Byte Count – 8 bits	20	Repeat start
28	Acknowledge from slave	21:27	Slave address – 7 bits
29:36	Data byte 0 – 8 bits	28	Read
37	Acknowledge from slave	29	Acknowledge from slave
38:45	Data byte 1 – 8 bits	30:37	Byte count from slave – 8 bits
46	Acknowledge from slave	38	Acknowledge
...	Data Byte N/Slave Acknowledge...	39:46	Data byte from slave – 8 bits

**Table 2. Block Read and Block Write Protocol (continued)**

Block Write Protocol		Block Read Protocol	
Bit	Description	Bit	Description
...	Data Byte N – 8 bits	47	Acknowledge
...	Acknowledge from slave	48:55	Data byte from slave – 8 bits
...	Stop	56	Acknowledge
		...	Data bytes from slave/Acknowledge
		...	Data byte N from slave – 8 bits
		...	Not Acknowledge
		...	Stop

**Table 3. Word Read and Word Write Protocol**

Word Write Protocol		Word Read Protocol	
Bit	Description	Bit	Description
1	Start	1	Start
2:8	Slave address – 7 bit	2:8	Slave address – 7 bit
9	Write	9	Write
10	Acknowledge from slave	10	Acknowledge from slave
11:18	Command Code – 8 bit '1xxxxxxx' stands for byte or word operation bit[6:0] of the command code represents the offset of the byte to be accessed	11:18	Command Code – 8 bit '1xxxxxxx' stands for byte or word operation bit[6:0] of the command code represents the offset of the byte to be accessed
19	Acknowledge from slave	19	Acknowledge from slave
20:27	Data byte low – 8 bits	20	Repeat start
28	Acknowledge from slave	21:27	Slave address – 7 bits
29:36	Data byte high – 8 bits	28	Read
37	Acknowledge from slave	29	Acknowledge from slave
38	Stop	30:37	Data byte low from slave – 8 bits
		38	Acknowledge
		39:46	Data byte high from slave – 8 bits
		47	NOT acknowledge
		48	Stop

**Table 4. Byte Read and Byte Write Protocol**

Byte Write Protocol		Byte Read Protocol	
Bit	Description	Bit	Description
1	Start	1	Start
2:8	Slave address – 7 bit	2:8	Slave address – 7 bit
9	Write	9	Write
10	Acknowledge from slave	10	Acknowledge from slave
11:18	Command Code – 8 bit '1xxxxxxx' stands for byte operation bit[6:0] of the command code represents the offset of the byte to be accessed	11:18	Command Code – 8 bit '1xxxxxxx' stands for byte operation bit[6:0] of the command code represents the offset of the byte to be accessed
19	Acknowledge from slave	19	Acknowledge from slave
20:27	Data byte – 8 bits	20	Repeat start
28	Acknowledge from slave	21:27	Slave address – 7 bits
29	Stop	28	Read

**Table 4. Byte Read and Byte Write Protocol (continued)**

Byte Write Protocol		Byte Read Protocol	
Bit	Description	Bit	Description
		29	Acknowledge from slave
		30:37	Data byte from slave – 8 bits
		38	Not Acknowledge
		39	Stop

**W305B Serial Configuration Map**

The serial bits will be read by the clock driver in the following order:

Byte 0 – Bits 7, 6, 5, 4, 3, 2, 1, 0

Byte 1 – Bits 7, 6, 5, 4, 3, 2, 1, 0

Byte N – Bits 7, 6, 5, 4, 3, 2, 1, 0

All unused register bits (reserved and N/A) should be written to a “0” level.

All register bits labeled “Initialize to 0” must be written to zero during initialization.

**Byte 0: Control Register 0**

Bit	Pin#	Name	Default	Description
Bit 7	-	SEL4	0	See Table 5
Bit 6	-	SEL3	0	See Table 5
Bit 5	-	SEL2	0	See Table 5
Bit 4	-	SEL1	0	See Table 5
Bit 3	-	SEL0	0	See Table 5
Bit 2	-	Spread Select2	0	'000' = Normal (spread off)
Bit 1	-	Spread Select1	0	'001' = Test Mode
Bit 0	-	Spread Select0	0	'010' = Reserved '011' = Three-States '100' = -0.5% '101' = ±0.5% '110' = ±0.25% '111' = ±0.38%

**Byte 1: Control Register 1**

Bit	Pin#	Name	Default	Description
Bit 7	23	Latched FS4 input	X	Latched FS[4:0] inputs. These bits are read only.
Bit 6	3	Latched FS3 input	X	
Bit 5	13	Latched FS2 input	X	
Bit 4	12	Latched FS1 input	X	
Bit 3	11	Latched FS0 input	X	
Bit 2	-	Reserved	0	Reserved
Bit 1	3	REF2X	1	(Active/Inactive)
Bit 0	-	Reserved	0	Reserved

**Byte 2: Control Register 2**

Bit	Pin#	Name	Default	Description
Bit 7	20	PCI7	1	(Active/Inactive)
Bit 6	19	PCI6	1	(Active/Inactive)
Bit 5	18	PCI5	1	(Active/Inactive)
Bit 4	16	PCI4	1	(Active/Inactive)

**Byte 2: Control Register 2 (continued)**

Bit	Pin#	Name	Default	Description
Bit 3	15	PCI3	1	(Active/Inactive)
Bit 2	13	PCI2	1	(Active/Inactive)
Bit 1	12	PCI1	1	(Active/Inactive)
Bit 0	11	PCI0	1	(Active/Inactive)

**Byte 3: Control Register 3**

Bit	Pin#	Name	Default	Description
Bit 7	9	3V66_2	1	(Active/Inactive)
Bit 6	8	3V66_1	1	(Active/Inactive)
Bit 5	7	3V66_0	1	(Active/Inactive)
Bit 4	55	APIC	1	(Active/Inactive)
Bit 3	-	Reserved	0	Reserved
Bit 2	-	Reserved	0	Reserved
Bit 1	51	CPU1	1	(Active/Inactive)
Bit 0	52	CPU0	1	(Active/Inactive)

**Byte 4: Control Register 4**

Bit	Pin#	Name	Default	Description
Bit 7	38	SDRAM7	1	(Active/Inactive)
Bit 6	41	SDRAM6	1	(Active/Inactive)
Bit 5	42	SDRAM5	1	(Active/Inactive)
Bit 4	43	SDRAM4	1	(Active/Inactive)
Bit 3	44	SDRAM3	1	(Active/Inactive)
Bit 2	47	SDRAM2	1	(Active/Inactive)
Bit 1	48	SDRAM1	1	(Active/Inactive)
Bit 0	49	SDRAM0	1	(Active/Inactive)

**Byte 5: Control Register 5**

Bit	Pin#	Name	Default	Description
Bit 7	-	Reserved	0	Reserved
Bit 6	-	Reserved	0	Reserved
Bit 5	-	Reserved	0	Reserved
Bit 4	31	SDRAM12	1	(Active/Inactive)
Bit 3	32	SDRAM11	1	(Active/Inactive)
Bit 2	35	SDRAM10	1	(Active/Inactive)
Bit 1	36	SDRAM9	1	(Active/Inactive)
Bit 0	37	SDRAM8	1	(Active/Inactive)



**Byte 6: Vendor ID & Revision ID Register (Read Only)**

Bit	Name	Default	Pin Description
Bit 7	Revision_ID3	0	Revision ID bit[3]
Bit 6	Revision_ID2	0	Revision ID bit[2]
Bit 5	Revision_ID1	0	Revision ID bit[1]
Bit 4	Revision_ID0	0	Revision ID bit[0]
Bit 3	Vendor_ID3	1	Bit[3] of Cypress Semiconductor's Vendor ID. This bit is read only.
Bit 2	Vendor_ID2	0	Bit[2] of Cypress Semiconductor's Vendor ID. This bit is read only.
Bit 1	Vendor_ID1	0	Bit[1] of Cypress Semiconductor's Vendor ID. This bit is read only.
Bit 0	Vendor_ID0	0	Bit[0] of Cypress Semiconductor's Vendor ID. This bit is read only.

**Byte 7: Control Register 7**

Bit	Pin#	Name	Default	Pin Description
Bit 7	-	Reserved	0	Reserved
Bit 6	24	24_48MHz_DRV	1	0 = Norm, 1 = High Drive
Bit 5	23	48MHz_DRV	1	0 = Norm, 1 = High Drive
Bit 4	22	48MHz_DRV	1	0 = Norm, 1 = High Drive
Bit 3	24	24_48MHz	1	(Active/Inactive)
Bit 2	23	48 MHz	1	(Active/Inactive)
Bit 1	22	48 MHz	1	(Active/Inactive)
Bit 0	--	Reserved	0	Reserved

**Byte 8: Watchdog Timer Register**

Bit	Name	Default	Pin Description
Bit 7	PCI_Skew1	0	PCI skew control 00 = Normal 01 = -500ps 10 = Reserved 11 = +500ps
Bit 6	PCI_Skew0	0	
Bit 5	WD_TIMER4	1	These bits store the time-out value of the Watchdog timer. The scale of the timer is determine by the pre-scaler. The timer can support a value of 150 ms to 4.8 sec when the pre-scaler is set to 150 ms. If the pre-scaler is set to 2.5 sec, it can support a value from 2.5 sec. to 80 sec. When the Watchdog timer reaches "0", it will set the WD_TO_STATUS bit.
Bit 4	WD_TIMER3	1	
Bit 3	WD_TIMER2	1	
Bit 2	WD_TIMER1	1	
Bit 1	WD_TIMER0	1	
Bit 0	WD_PRE_SCALER	0	0 = 150 ms 1 = 2.5 sec

**Byte 9: System RESET and Watchdog Timer Register**

Bit	Name	Default	Pin Description
Bit 7	SDRAM_DRV	0	SDRAM clock output drive strength 0 = Normal 1 = High Drive
Bit 6	PCI_DRV	0	PCI clock output drive strength 0 = Normal 1 = High Drive
Bit 5	FS_Override	0	0 = Select operating frequency by FS[4:0] input pins 1 = Select operating frequency by SEL[4:0] settings

**Byte 9: System RESET and Watchdog Timer Register (continued)**

Bit	Name	Default	Pin Description
Bit 4	RST_EN_WD	0	This bit will enable the generation of a Reset pulse when a watchdog timer time-out occurs. 0 = Disabled 1 = Enabled
Bit 3	RST_EN_FC	0	This bit will enable the generation of a Reset pulse after a frequency change occurs. 0 = Disabled 1 = Enabled
Bit 2	WD_TO_STATUS	0	Watchdog Timer Time-out Status bit 0 = No time-out occurs (READ); Ignore (WRITE) 1 = time-out occurred (READ); Clear WD_TO_STATUS (WRITE)
Bit 1	WD_EN	0	0 = Stop and re-load Watchdog timer. Unlock W305B from recovery frequency mode. 1 = Enable Watchdog timer. It will start counting down after a frequency change occurs. <b>Note:</b> W305B will generate system reset, re-load a recovery frequency, and lock itself into a recovery frequency mode after a Watchdog timer time-out occurs. Under recovery frequency mode, W305B will not respond to any attempt to change output frequency via the SMBus control bytes. System software can unlock W305B from its recovery frequency mode by clearing the WD_EN bit.
Bit 0	Reserved	0	Reserved

**Byte 10: Skew Control Register**

Bit	Name	Default	Description
Bit 7	CPU_Skew2	0	CPU skew control 000 = Normal 001 = -150 ps 010 = -300 ps 011 = -450 ps 100 = +150 ps 101 = +300 ps 110 = +450 ps 111 = +600 ps
Bit 6	CPU_Skew1	0	
Bit 5	CPU_Skew0	0	
Bit 4	SDRAM_Skew2	0	SDRAM skew control 000 = Normal 001 = -150 ps 010 = -300 ps 011 = -450 ps 100 = +150 ps 101 = +300 ps 110 = +450 ps 111 = +600 ps
Bit 3	SDRAM_Skew1	0	
Bit 2	SDRAM_Skew0	0	
Bit 1	AGP_Skew1	0	AGP skew control 00 = Normal 01 = -150ps 10 = +150ps 11 = +300ps
Bit 0	AGP_Skew0	0	

**Byte 11: Recovery Frequency N-Value Register**

Bit	Name	Default	Pin Description
Bit 7	ROCV_FREQ_N7	0	<p>If ROCV_FREQ_SEL is set, W305B will use the values programmed in ROCV_FREQ_N[7:0] and ROCV_FREQ_M[6:0] to determine the recovery CPU output frequency when a Watchdog timer time-out occurs</p> <p>The setting of FS_Override bit determines the frequency ratio for CPU, SDRAM, AGP and SDRAM. When it is cleared, W305b will use the same frequency ratio stated in the Latched FS[4:0] register. When it is set, W305B will use the frequency ratio stated in the SEL[4:0] register.</p> <p>W305B supports programmable CPU frequency ranging from 50 MHz to 248 MHz.</p> <p>W305B will change the output frequency whenever there is an update to either ROCV_FREQ_N[7:0] and ROCV_FREQ_M[6:0]. Therefore, it is recommended to use Word or Block write to update both registers within the same SMBus bus operation.</p>
Bit 6	ROCV_FREQ_N6	0	
Bit 5	ROCV_FREQ_N5	0	
Bit 4	ROCV_FREQ_N4	0	
Bit 3	ROCV_FREQ_N3	0	
Bit 2	ROCV_FREQ_N2	0	
Bit 1	ROCV_FREQ_N1	0	
Bit 0	ROCV_FREQ_N0	0	

**Byte 12: Recovery Frequency M-Value Register**

Bit	Name	Default	Pin Description
Bit 7	ROCV_FREQ_SEL	0	<p>ROCV_FREQ_SEL determines the source of the recover frequency when a Watchdog timer time-out occurs. The clock generator will automatically switch to the recovery CPU frequency based on the selection on ROCV_FREQ_SEL.</p> <p>0 = From latched FS[4:0] 1 = From the settings of ROCV_FREQ_N[7:0] &amp; ROCV_FREQ_M[6:0]</p>
Bit 6	ROCV_FREQ_M6	0	
Bit 5	ROCV_FREQ_M5	0	<p>If ROCV_FREQ_SEL is set, W305B will use the values programmed in ROCV_FREQ_N[7:0] and ROCV_FREQ_M[6:0] to determine the recovery CPU output frequency when a Watchdog timer time-out occurs</p> <p>The setting of FS_Override bit determines the frequency ratio for CPU, SDRAM, AGP and SDRAM. When it is cleared, W305b will use the same frequency ratio stated in the Latched FS[4:0] register. When it is set, W305B will use the frequency ratio stated in the SEL[4:0] register.</p> <p>W305B supports programmable CPU frequency ranging from 50 MHz to 248 MHz.</p> <p>W305B will change the output frequency whenever there is an update to either ROCV_FREQ_N[7:0] and ROCV_FREQ_M[6:0]. Therefore, it is recommended to use Word or Block write to update both registers within the same SMBus bus operation.</p>
Bit 4	ROCV_FREQ_M4	0	
Bit 3	ROCV_FREQ_M3	0	
Bit 2	ROCV_FREQ_M2	0	
Bit 1	ROCV_FREQ_M1	0	
Bit 0	ROCV_FREQ_M0	0	

**Byte 13: Programmable Frequency Select N-Value Register**

Bit	Name	Default	Pin Description
Bit 7	CPU_FSEL_N7	0	<p>If Prog_Freq_EN is set, W305B will use the values programmed in CPU_FSEL_N[7:0] and CPU_FSEL_M[6:0] to determine the CPU output frequency. The new frequency will start to load whenever CPU_FSELM[6:0] is updated.</p> <p>The setting of FS_Override bit determines the frequency ratio for CPU, SDRAM, AGP and SDRAM. When it is cleared, W305B will use the same frequency ratio stated in the Latched FS[4:0] register. When it is set, W305B will use the frequency ratio stated in the SEL[4:0] register.</p> <p>W305B supports programmable CPU frequency ranging from 50 MHz to 248 MHz.</p>
Bit 6	CPU_FSEL_N6	0	
Bit 5	CPU_FSEL_N5	0	
Bit 4	CPU_FSEL_N4	0	
Bit 3	CPU_FSEL_N3	0	
Bit 2	CPU_FSEL_N2	0	
Bit 1	CPU_FSEL_N1	0	
Bit 0	CPU_FSEL_N0	0	

**Byte 14: Programmable Frequency Select M-Value Register**

Bit	Name	Default	Description
Bit 7	Pro_Freq_EN	0	Programmable output frequencies enabled 0 = disabled 1 = enabled
Bit 6	CPU_FSEL_M6	0	If Prog_Freq_EN is set, W305B will use the values programmed in CPU_FSEL_N[7:0] and CPU_FSEL_M[6:0] to determine the CPU output frequency. The new frequency will start to load whenever CPU_FSELM[6:0] is updated. The setting of FS_Override bit determines the frequency ratio for CPU, SDRAM, AGP and SDRAM. When it is cleared, W305B will use the same frequency ratio stated in the Latched FS[4:0] register. When it is set, W305B will use the frequency ratio stated in the SEL[4:0] register. W305B supports programmable CPU frequency ranging from 50 MHz to 248 MHz.
Bit 5	CPU_FSEL_M5	0	
Bit 4	CPU_FSEL_M4	0	
Bit 3	CPU_FSEL_M3	0	
Bit 2	CPU_FSEL_M2	0	
Bit 1	CPU_FSEL_M1	0	
Bit 0	CPU_FSEL_M0	0	

**Byte 15: Reserved Register**

Bit	Pin#	Name	Default	Description
Bit 7	-	Reserved	0	Reserved
Bit 6	-	Reserved	0	Reserved
Bit 5	-	Reserved	0	Reserved
Bit 4	-	Reserved	0	Reserved
Bit 3	-	Reserved	0	Reserved
Bit 2	-	Reserved	0	Reserved
Bit 1	-	Reserved	1	Reserved. Write with '1'
Bit 0	-	Reserved	1	Reserved. Write with '1'

**Byte 16: Reserved Register**

Bit	Pin#	Name	Default	Description
Bit 7	-	Reserved	0	Reserved
Bit 6	-	Reserved	0	Reserved
Bit 5	-	Reserved	0	Reserved
Bit 4	-	Reserved	0	Reserved
Bit 3	-	Reserved	0	Reserved
Bit 2	-	Reserved	0	Reserved
Bit 1	-	Reserved	0	Reserved

**Byte 17: Reserved Register**

Bit	Pin#	Name	Default	Description
Bit 7	-	Reserved	0	Reserved
Bit 6	-	Reserved	0	Reserved
Bit 5	-	Reserved	0	Reserved
Bit 4	-	Reserved	0	Reserved
Bit 3	-	Reserved	0	Reserved
Bit 2	-	Reserved	0	Reserved
Bit 1	-	Reserved	0	Reserved

**Table 5. Additional Frequency Selections through Serial Data Interface Data Bytes**

Input Conditions					Output Frequency					PLL Gear Constants (G)
FS4 SEL4	FS3 SEL3	FS2 SEL2	FS1 SEL1	FS0 SEL0	CPU	SDRAM	3V66	PCI	APIC	
0	0	0	0	0	66.6	100.0	66.6	33.3	16.6	32.00494
0	0	0	0	1	120.0	120.0	80.0	40.0	20.0	48.00741
0	0	0	1	0	66.8	100.2	66.8	33.4	16.7	32.00494
0	0	0	1	1	68.3	102.5	68.3	34.2	17.1	32.00494
0	0	1	0	0	70.0	105.0	70.0	35.0	17.5	32.00494
0	0	1	0	1	75.0	112.5	75.0	37.5	18.8	32.00494
0	0	1	1	0	80.0	120.0	80.0	40.0	20.0	32.00494
0	0	1	1	1	83.0	124.5	83.0	41.5	20.8	32.00494
0	1	0	0	0	100.0	100.0	66.6	33.3	16.6	48.00741
0	1	0	0	1	124.0	124.0	82.6	41.3	20.6	48.00741
0	1	0	1	0	100.2	100.2	66.8	33.4	16.7	48.00741
0	1	0	1	1	103.0	103.0	68.9	34.3	17.2	48.00741
0	1	1	0	0	105.0	105.0	70.0	35.0	17.5	48.00741
0	1	1	0	1	110.0	110.0	73.3	36.7	18.3	48.00741
0	1	1	1	0	115.0	115.0	76.6	38.3	19.1	48.00741
0	1	1	1	1	200.0	200.0	66.6	33.3	16.6	96.01482
1	0	0	0	0	133.3	133.3	66.6	33.3	16.6	64.00988
1	0	0	0	1	166.6	166.6	83.3	41.6	20.8	64.00988
1	0	0	1	0	133.6	133.6	66.8	33.4	16.7	64.00988
1	0	0	1	1	137.0	137.0	68.5	34.3	17.1	64.00988
1	0	1	0	0	140.0	140.0	70.0	35.0	17.5	64.00988
1	0	1	0	1	145.0	145.0	72.5	36.2	18.1	64.00988
1	0	1	1	0	150.0	150.0	75.0	37.5	18.7	64.00988
1	0	1	1	1	160.0	160.0	80.0	40.0	20.0	64.00988
1	1	0	0	0	133.3	100.0	66.6	33.3	16.6	64.00988
1	1	0	0	1	166.6	125.0	83.3	41.7	20.8	64.00988
1	1	0	1	0	133.6	100.2	66.8	33.4	16.7	64.00988
1	1	0	1	1	137.0	102.8	68.5	34.3	17.1	64.00988
1	1	1	0	0	66.6	100.0	66.6	33.3	16.6	32.00494
1	1	1	0	1	100.0	100.0	66.6	33.3	16.6	48.00741
1	1	1	1	0	133.3	133.3	66.6	33.3	16.6	64.00988
1	1	1	1	1	133.3	100.0	66.6	33.3	16.6	64.00988

## Programmable Output Frequency, Watchdog Timer and Recovery Output Frequency Functional Description

The Programmable Output Frequency feature allows users to generate any CPU output frequency from the range of 50 MHz to 248 MHz. Cypress offers the most dynamic and the simplest programming interface for system developers to utilize this feature in their platforms.

The Watchdog Timer and Recovery Output Frequency features allow users to implement a recovery mechanism when the system hangs or getting unstable. System BIOS or other control software can enable the Watchdog timer before they attempt to make a frequency change. If the system hangs and a Watchdog timer time-out occurs, a system reset will be generated and a recovery frequency will be activated.

All the related registers are summarized in the following table.

**Table 6. Register Summary**

Name	Description
Pro_Freq_EN	<p>Programmable output frequencies enabled 0 = disabled (default) 1 = enabled</p> <p>When it is disabled, the operating output frequency will be determined by either the latched value of FS[4:0] inputs or the programmed value of SEL[4:0]. If FS_Override bit is clear, latched FS[4:0] inputs will be used. If FS_Override bit is set, programmed value of SEL[4:0] will be used.</p> <p>When it is enabled, the CPU output frequency will be determined by the programmed value of CPUFSEL_N, CPUFSEL_M and the PLL Gear Constant. The program value of FS_Override, SEL[4:0] or the latched value of FS[4:0] will determine the PLL Gear Constant and the frequency ratio between CPU and other frequency outputs</p>
FS_Override	<p>When Pro_Freq_EN is cleared or disabled, 0 = Select operating frequency by FS input pins (default) 1 = Select operating frequency by SEL bits in SMBus control bytes</p> <p>When Pro_Freq_EN is set or enabled, 0 = Frequency output ratio between CPU and other frequency groups and the PLL Gear Constant are based on the latched value of FS input pins (default) 1 = Frequency output ratio between CPU and other frequency groups and the PLL Gear Constant are based on the programmed value of SEL bits in SMBus control bytes</p>
CPU_FSEL_N, CPU_FSEL_M	<p>When Prog_Freq_EN is set or enabled, the values programmed in CPU_FSEL_N[7:0] and CPU_FSEL_M[6:0] determines the CPU output frequency. The new frequency will start to load whenever there is an update to either CPU_FSEL_N[7:0] or CPU_FSEL_M[6:0]. Therefore, it is recommended to use Word or Block write to update both registers within the same SMBus bus operation.</p> <p>The setting of FS_Override bit determines the frequency ratio for CPU, SDRAM, AGP and SDRAM. When FS_Override is cleared or disabled, the frequency ratio follows the latched value of the FS input pins. When FS_Override is set or enabled, the frequency ratio follows the programmed value of SEL bits in SMBus control bytes.</p>
ROCV_FREQ_SEL	<p>ROCV_FREQ_SEL determines the source of the recover frequency when a Watchdog timer time-out occurs. The clock generator will automatically switch to the recovery CPU frequency based on the selection on ROCV_FREQ_SEL. 0 = From latched FS[4:0] 1 = From the settings of ROCV_FREQ_N[7:0] &amp; ROCV_FREQ_M[6:0]</p>
ROCV_FREQ_N[7:0], ROCV_FREQ_M[6:0]	<p>When ROCV_FREQ_SEL is set, the values programmed in ROCV_FREQ_N[7:0] and ROCV_FREQ_M[6:0] will be used to determine the recovery CPU output frequency when a Watchdog timer time-out occurs</p> <p>The setting of FS_Override bit determines the frequency ratio for CPU, SDRAM, AGP and SDRAM. When it is cleared, the same frequency ratio stated in the Latched FS[4:0] register will be used. When it is set, the frequency ratio stated in the SEL[4:0] register will be used.</p> <p>The new frequency will start to load whenever there is an update to either ROCV_FREQ_N[7:0] and ROCV_FREQ_M[6:0]. Therefore, it is recommended to use Word or Block write to update both registers within the same SMBus bus operation.</p>

**Table 6. Register Summary** (continued)

Name	Description
WD_EN	0 = Stop and re-load Watchdog timer. Unlock W305B from recovery frequency mode. 1 = Enable Watchdog timer. It will start counting down after a frequency change occurs. <b>Note.</b> W305B will generate system reset, re-load a recovery frequency, and lock itself into a recovery frequency mode after a Watchdog timer time-out occurs. Under recovery frequency mode, W305B will not respond to any attempt to change output frequency via the SMBus control bytes. System software can unlock W305B from its recovery frequency mode by clearing the WD_EN bit.
WD_TO_STATUS	Watchdog Timer Time-out Status bit 0 = No time-out occurs (READ); Ignore (WRITE) 1 = time-out occurred (READ); Clear WD_TO_STATUS (WRITE)
WD_TIMER[4:0]	These bits store the time-out value of the Watchdog timer. The scale of the timer is determine by the pre-scaler. The timer can support a value of 150 ms to 4.8 sec. when the pre-scaler is set to 150 ms. If the pre-scaler is set to 2.5 sec, it can support a value from 2.5 sec to 80 sec. When the Watchdog timer reaches "0", it will set the WD_TO_STATUS bit.
WD_PRE_SCALER	0 = 150 ms 1 = 2.5 sec
RST_EN_WD	This bit will enable the generation of a Reset pulse when a watchdog timer time-out occurs. 0 = Disabled 1 = Enabled
RST_EN_FC	This bit will enable the generation of a Reset pulse after a frequency change occurs. 0 = Disabled 1 = Enabled

**How to Program CPU Output Frequency**

When the programmable output frequency feature is enabled (Pro\_Freq\_EN bit is set), the CPU output frequency is determined by the following equation:

$$F_{cpu} = G * (N+3)/(M+3)$$

"N" and "M" are the values programmed in Programmable Frequency Select N-Value Register and M-Value Register, respectively.

"G" stands for the PLL Gear Constant, which is determined by the programmed value of FS[4:0] or SEL[4:0]. The value is listed in Table 5.

The following table lists the recommended frequency output ranges for each PLL Gear Constant and its associated Bus Frequency Ratio so that the maximum AGP and PCI output frequencies are less than or equal to 83.1 MHz and 41.5 MHz, respectively.

**Table 7. Recommended CPU Frequency Range for Different PLL Gear Ratio**

Gear Constants	Bus Frequency Ratio (CPU/SDRAM/AGP/PCI)	Recommended Output Frequency Range (CPU/SDRAM/AGP/PCI)	
		Lower Limits (N=77, M=48)	Upper Limits (N=106, M=39)
G1 (32.00494)	66 / 100 / 66 / 33	50.2 / 75.8 / 50.2 / 25.1	83.1 / 124.7 / 83.1 / 41.5
G2 (48.00741)	100 / 100 / 66 / 33	75.3 / 75.3 / 50.2 / 25.1	124.6 / 124.6 / 83.1 / 41.5
G3 (64.00988)	133 / 133 / 66 / 33	100.4 / 100.4 / 50.2 / 25.1	166.1 / 166.1 / 83.1 / 41.5
	or 133 / 100 / 66 / 33	100.4 / 75.3 / 50.2 / 25.1	166.1 / 124.5 / 83.1 / 41.5
G4 (96.01482)	200 / 200 / 66 / 33	150.6 / 150.6 / 50.2 / 25.1	249.2 / 249.2 / 83.1 / 41.5

**Absolute Maximum DC Power Supply**

Parameter	Description	Min.	Max.	Unit
V <sub>DDQ3</sub>	3.3V Core Supply Voltage	-0.5	4.6	V
V <sub>DDQ2</sub>	2.5V I/O Supply Voltage	-0.5	3.6	V
T <sub>s</sub>	Storage Temperature	-65	150	°C

**Absolute Maximum DC I/O**

Parameter	Description	Min.	Max.	Unit
V <sub>i/o3</sub>	3.3V Core Supply Voltage	-0.5	4.6	V
V <sub>i/o3</sub>	2.5V I/O Supply Voltage	-0.5	3.6	V
ESD prot.	Input ESD Protection	2000		V

**DC Electrical Characteristics** <sup>[2]</sup>

DC parameters must be sustainable under steady state (DC) conditions.

**DC Operating Requirements**

Parameter	Description	Condition	Min.	Max.	Unit
V <sub>DD3</sub>	3.3V Core Supply Voltage	3.3V±5%	3.135	3.465	V
V <sub>DDQ3</sub>	3.3V I/O Supply Voltage	3.3V±5%	3.135	3.465	V
V <sub>DDQ2</sub>	2.5V I/O Supply Voltage	2.5V±5%	2.375	2.625	V
<b>V<sub>DD3</sub> = 3.3V±5%</b>					
V <sub>ih3</sub>	3.3V Input High Voltage	V <sub>DD3</sub>	2.0	V <sub>DD</sub> + 0.3	V
V <sub>il3</sub>	3.3V Input Low Voltage		V <sub>SS</sub> - 0.3	0.8	V
I <sub>il</sub>	Input Leakage Current <sup>[3]</sup>	0 < V <sub>in</sub> < V <sub>DD3</sub>	-5	+5	µA
<b>V<sub>DDQ2</sub> = 2.5V±5%</b>					
V <sub>oh2</sub>	2.5V Output High Voltage	I <sub>oh</sub> = (-1 mA)	2.0		V
V <sub>ol2</sub>	2.5V Output Low Voltage	I <sub>ol</sub> = (1 mA)		0.4	V
<b>V<sub>DDQ3</sub> = 3.3V±5%</b>					
V <sub>oh3</sub>	3.3V Output High Voltage	I <sub>oh</sub> = (-1 mA)	2.4		V
V <sub>ol3</sub>	3.3V Output Low Voltage	I <sub>ol</sub> = (1 mA)		0.4	V
<b>V<sub>DDQ3</sub> = 3.3V±5%</b>					
V <sub>poh3</sub>	PCI Bus Output High Voltage	I <sub>oh</sub> = (-1 mA)	2.4		V
V <sub>pol3</sub>	PCI Bus Output Low Voltage	I <sub>ol</sub> = (1 mA)		0.55	V
C <sub>in</sub>	Input Pin Capacitance			5	pF
C <sub>xtal</sub>	Xtal Pin Capacitance		13.5	22.5	pF
C <sub>out</sub>	Output Pin Capacitance			6	pF
L <sub>pin</sub>	Pin Inductance		0	7	nH
T <sub>a</sub>	Ambient Temperature	No Airflow	0	70	°C

**Notes:**

- Multiple Supplies:** The voltage on any input or I/O pin cannot exceed the power pin during power-up. Power supply sequencing is NOT req
- Input Leakage Current does not include inputs with pull-up or pull-down resistors.



**AC Electrical Characteristics**  $T_A = 0^\circ\text{C to } +70^\circ\text{C}$ ,  $V_{DDQ3} = 3.3\text{V}\pm 5\%$ ,  $V_{DDQ2} = 2.5\text{V}\pm 5\%$ ,  $f_{XTL} = 14.31818 \text{ MHz}^{[2]}$ 

Parameter	Description	66.6-MHz Host		100-MHz Host		133-MHz Host		Unit	Notes
		Min.	Max.	Min.	Max.	Min.	Max.		
$T_{\text{Period}}$	Host/CPUCLK Period	15.0	15.5	10.0	10.5	7.5	8.0	ns	4
$T_{\text{HIGH}}$	Host/CPUCLK High Time	5.2	N/A	3.0	N/A	1.87	N/A	ns	4,7
$T_{\text{LOW}}$	Host/CPUCLK Low Time	5.0	N/A	2.8	N/A	1.67	N/A	ns	5
$T_{\text{RISE}}$	Host/CPUCLK Rise Time	0.4	1.6	0.4	1.6	0.4	1.6	ns	
$T_{\text{FALL}}$	Host/CPUCLK Fall Time	0.4	1.6	0.4	1.6	0.4	1.6	ns	
$T_{\text{Period}}$	SDRAM CLK Period	10.0	10.5	10.0	10.5	10.0	10.5	ns	4
$T_{\text{HIGH}}$	SDRAM CLK High Time	3.0	N/A	3.0	N/A	3.0	N/A	ns	4
$T_{\text{LOW}}$	SDRAM CLK Low Time	2.8	N/A	2.8	N/A	2.8	N/A	ns	5
$T_{\text{RISE}}$	SDRAM CLK Rise Time	0.4	1.6	0.4	1.6	0.4	1.6	ns	
$T_{\text{FALL}}$	SDRAM CLK Fall Time	0.4	1.6	0.4	1.6	0.4	1.6	ns	
$T_{\text{Period}}$	APIC CLK Period	60.0	64.0	60.0	N/A	60.0	64.0	ns	4
$T_{\text{HIGH}}$	APIC CLK High Time	25.5	N/A	25.5	N/A	25.5	N/A	ns	4
$T_{\text{LOW}}$	APIC CLK Low Time	25.3	N/A	25.30	N/A	25.30	N/A	ns	5
$T_{\text{RISE}}$	APIC CLK Rise Time	0.4	1.6	0.4	1.6	0.4	1.6	ns	
$T_{\text{FALL}}$	APIC CLK Fall Time	0.4	1.6	0.4	1.6	0.4	1.6	ns	
$T_{\text{Period}}$	3V66 CLK Period	15.0	16.0	15.0	16.0	15.0	16.0	ns	4, 5
$T_{\text{HIGH}}$	3V66 CLK High Time	5.25	N/A	5.25	N/A	5.25	N/A	ns	4
$T_{\text{LOW}}$	3V66 CLK Low Time	5.05	N/A	5.05	N/A	5.05	N/A	ns	5
$T_{\text{RISE}}$	3V66 CLK Rise Time	0.5	2.0	0.5	2.0	0.5	2.0	ns	
$T_{\text{FALL}}$	3V66 CLK Fall Time	0.5	2.0	0.5	2.0	0.5	2.0	ns	
$T_{\text{Period}}$	PCI CLK Period	30.0	N/A	30.0	N/A	30.0	N/A	ns	4, 7
$T_{\text{HIGH}}$	PCI CLK High Time	12.0	N/A	12.0	N/A	12.0	N/A	ns	4
$T_{\text{LOW}}$	PCI CLK Low Time	12.0	N/A	12.0	N/A	12.0	N/A	ns	5
$T_{\text{RISE}}$	PCI CLK Rise Time	0.5	2.0	0.5	2.0	0.5	2.0	ns	
$T_{\text{FALL}}$	PCI CLK Fall Time	0.5	2.0	0.5	2.0	0.5	2.0	ns	
$t_{\text{pZL}}, t_{\text{pZH}}$	Output Enable Delay (All outputs)	1.0	10.0	1.0	10.0	1.0	10.0	ns	
$t_{\text{pLZ}}, t_{\text{pZH}}$	Output Disable Delay (All outputs)	1.0	10.0	1.0	10.0	1.0	10.0	ns	
$t_{\text{stable}}$	All Clock Stabilization from Power-Up		3		3		3	ms	

**Notes:**

4. Period, jitter, offset, and skew measured on rising edge at 1.25 for 2.5V clocks and at 1.5V for 3.3V clocks.
5. The time specified is measured from when  $V_{DDQ3}$  achieves its nominal operating level (typical condition  $V_{DDQ3} = 3.3\text{V}$ ) until the frequency output is stable and operating within specification.
6.  $T_{\text{RISE}}$  and  $T_{\text{FALL}}$  are measured as a transition through the threshold region  $V_{\text{ol}} = 0.4\text{V}$  and  $V_{\text{oh}} = 2.0\text{V}$  (1 mA) JEDEC specification.
7.  $T_{\text{LOW}}$  is measured at 0.4V for all outputs.
8.  $T_{\text{HIGH}}$  is measured at 2.0V for 2.5V outputs, 2.4V for 3.3V outputs.

**Group Skew and Jitter Limits**

Output Group	Pin-Pin Skew Max.	Cycle-Cycle Jitter	Duty Cycle	Nom Vdd	Skew, Jitter Measure Point
CPU	175 ps	250 ps	45/55	2.5V	1.25V
SDRAM	250 ps	250 ps	45/55	3.3V	1.5V
APIC	250 ps	500 ps	45/55	2.5V	1.25V
48MHz	250 ps	500 ps	45/55	3.3V	1.5V
3V66	175 ps	500 ps	45/55	3.3V	1.5V
PCI	500 ps	500 ps	45/55	3.3V	1.5V
REF	N/A	1000 ps	45/55	3.3V	1.5V

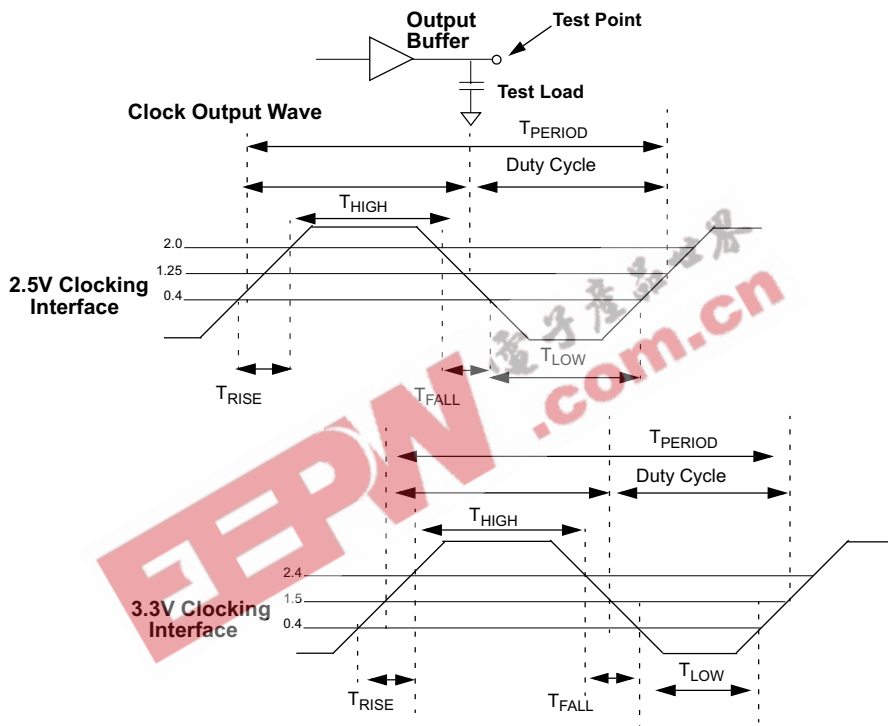

**Figure 6. Output Buffer  
Layout Example**

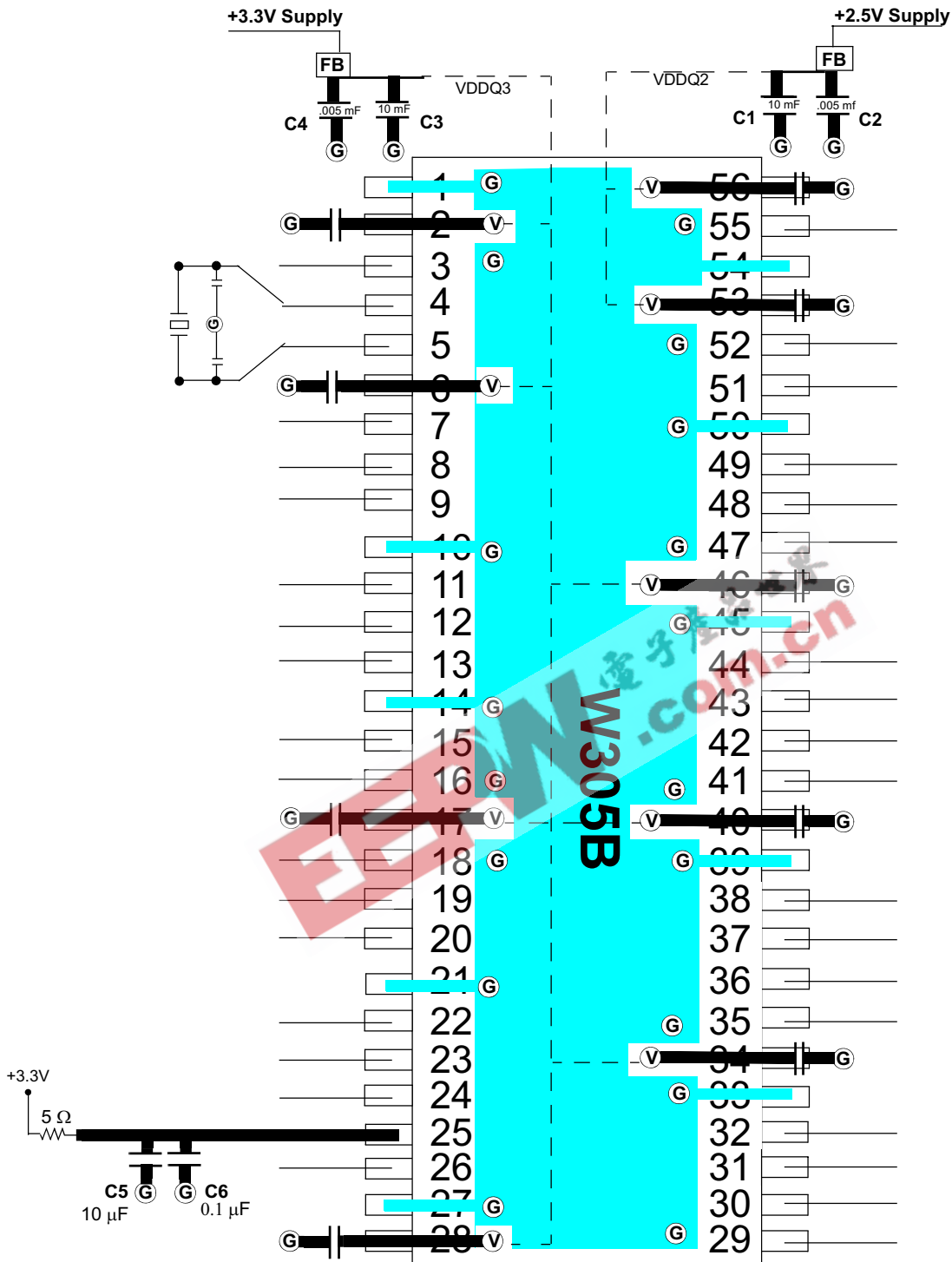

FB = Dale ILB1206 - 300 (300Ω @ 100 MHz) or TDK ACB 2012L-120

Ceramic Cap C1, C3 & C5 = 10 - 22 μF C2 & C4 = .005 μF C6 = 0.1 μF

ⓐ = VIA to GND plane layer Ⓥ = VIA to respective supply plane layer

Note: Each supply plane or strip should have a ferrite bead and capacitors

**Ordering Information**

Ordering Code	Package Type	Operating Range
W305BH	56-pin SSOP (300 mils)	Commercial
W305BHH	56-pin SSOP (300 mils) – Tape and Reel	Commercial
<b>Lead Free</b>		
CYW305OXC	56-pin SSOP (300 mils)	Commercial
CYW305OXCT	56-pin SSOP (300 mils) – Tape and Reel	Commercial

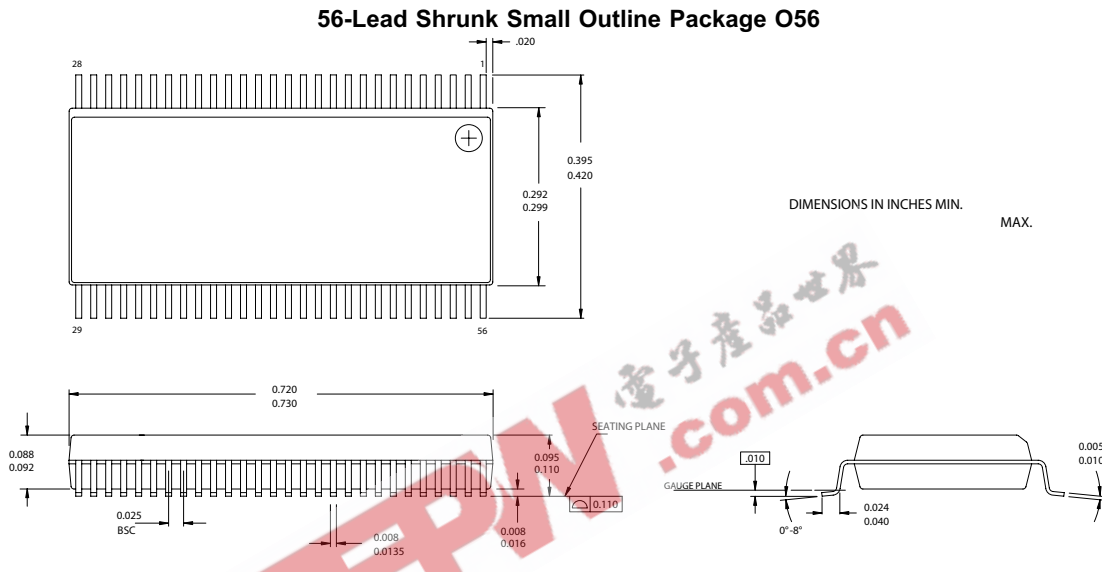
**Package Drawing Dimension**

While SLI has reviewed all information herein for accuracy and reliability, Spectra Linear Inc. assumes no responsibility for the use of any circuitry or for the infringement of any patents or other rights of third parties which would result from each use. This product is intended for use in normal commercial applications and is not warranted nor is it intended for use in life support, critical medical instruments, or any other application requiring extended temperature range, high reliability, or any other extraordinary environmental requirements unless pursuant to additional processing by Spectra Linear Inc., and expressed written agreement by Spectra Linear Inc. Spectra Linear Inc. reserves the right to change any circuitry or specification without notice.