



# 1Mx32 3.3V Flash Module

## FEATURES

- Access Times of 100, 120, 150ns
- Packaging
  - 66 pin, PGA Type, 1.185" square, Hermetic Ceramic HIP (Package 401)
  - 68 lead, Low Profile CQFP (G2T), 4.6mm (0.180") square (Package 509)
- 1,000,000 Erase/Program Cycles
- Sector Architecture
  - One 16KByte, two 8KBytes, one 32KByte, and fifteen 64kBytes in byte mode
  - Any combination of sectors can be concurrently erased. Also supports full chip erase
- Organized as 1Mx32
- Commercial, Industrial and Military Temperature Ranges
- 3.3 Volt for Read and Write Operations
- Boot Code Sector Architecture (Bottom)
- Low Power CMOS, 1.0mA Standby
- Embedded Erase and Program Algorithms
- Built-in Decoupling Caps for Low Noise Operation
- Erase Suspend/Resume
  - Supports reading data from or programing data to a sector not being erased
- Low Current Consumption
 

Typical values at 5MHz:

  - 40mA Active Read Current
  - 80mA Program/Erase Current
- Weight
  - WF1M32B-XG2TX3 -8 grams typical
  - WF1M32B-XHX3 -13 grams typical

Note: For programming information refer to Flash Programming 8M3 Application Note.

### PIN CONFIGURATION FOR WF1M32B-XHX3

#### Top View

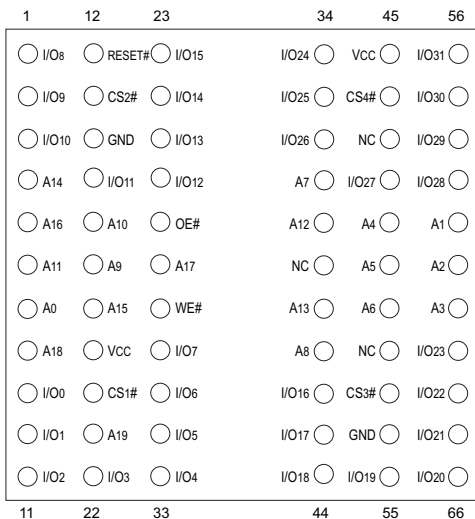

### Pin Description

I/O0-31	Data Inputs/Outputs
A0-19	Address Inputs
WE#	Write Enable
CS1-4#	Chip Selects
OE#	Output Enable
RESET#	Reset
VCC	Power Supply
GND	Ground
NC	Not Connected

### Block Diagram

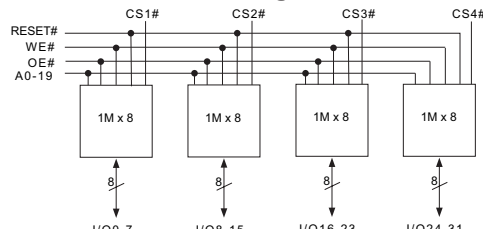



**Pin Configuration for WF1M32B-XG2TX3**  
Top View

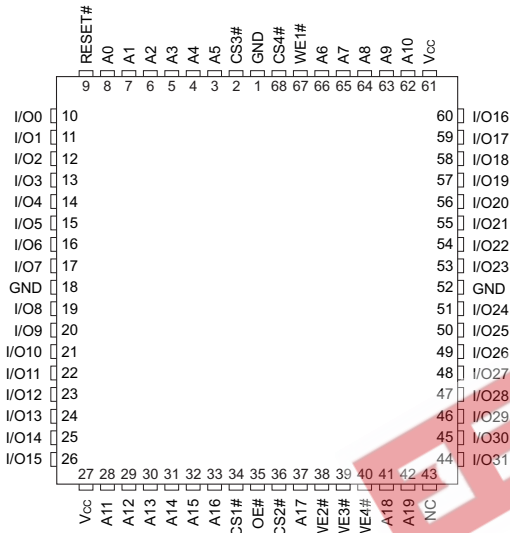

**Pin Description**

I/O0-31	Data Inputs/Outputs
A0-19	Address Inputs
WE1-4	Write Enables
CS1-4	Chip Selects
OE	Output Enable
RESET	Reset/Powerdown
Vcc	Power Supply
GND	Ground

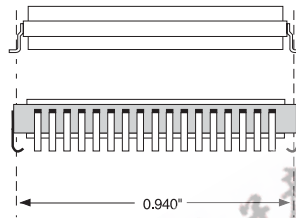

The White 68 lead G2T CQFP fills the same fit and function as the JEDEC 68 lead CQFJ or 68 PLCC. But the G2T has the TCE and lead inspection advantage of the CQFP form.

**Block Diagram**

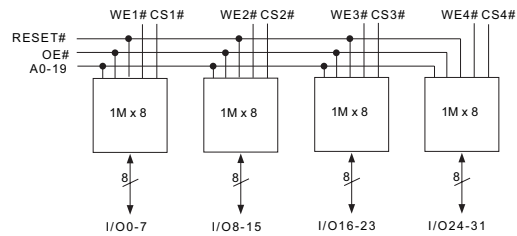



**ABSOLUTE MAXIMUM RATINGS**

Parameter		Unit
Operating Temperature	-55 to +125	°C
Supply Voltage Range (V <sub>CC</sub> )	-0.5 to +4.0	V
Signal Voltage Range	-0.5 to V <sub>CC</sub> +0.5	V
Storage Temperature Range	-65 to +150	°C
Lead Temperature (soldering, 10 seconds)	+300	°C
Endurance (write/erase cycles)	1,000,000 min.	cycles

NOTES:

- Stresses above the absolute maximum rating may cause permanent damage to the device. Extended operation at the maximum levels may degrade performance and affect reliability.

**CAPACITANCE**

T<sub>A</sub> = +25°C

Parameter	Symbol	Conditions	Max	Unit
OE# capacitance	C <sub>OE</sub>	V <sub>IN</sub> = 0 V, f = 1.0 MHz	50	pF
WE#1-4 capacitance	C <sub>WE</sub>	V <sub>IN</sub> = 0 V, f = 1.0 MHz	20	pF
CS1-4 capacitance	C <sub>CS</sub>	V <sub>IN</sub> = 0 V, f = 1.0 MHz	20	pF
Data I/O capacitance	C <sub>I/O</sub>	V <sub>I/O</sub> = 0 V, f = 1.0 MHz	20	pF
Address input capacitance	C <sub>AD</sub>	V <sub>IN</sub> = 0 V, f = 1.0 MHz	50	pF

This parameter is guaranteed by design but not tested.

**RECOMMENDED OPERATING CONDITIONS**

Parameter	Symbol	Min	Max	Unit
Supply Voltage	V <sub>CC</sub>	3.0	3.6	V
Input High Voltage	V <sub>IH</sub>	0.7 x V <sub>CC</sub>	V <sub>CC</sub> + 0.3	V
Input Low Voltage	V <sub>IL</sub>	-0.5	+0.8	V
Operating Temp. (Mil.)	T <sub>A</sub>	-55	+125	°C
Operating Temp. (Ind.)	T <sub>A</sub>	-40	+85	°C

**DATA RETENTION**

Parameter	Test Conditions	Min	Unit
Minimum Pattern Data Retention Time	150°C	10	Years
	125°C	20	Years

**DC CHARACTERISTICS – CMOS COMPATIBLE**

V<sub>CC</sub> = 3.3V, V<sub>SS</sub> = 0V, -55°C ≤ T<sub>A</sub> ≤ +125°C

Parameter	Symbol	Conditions	Min	Max	Unit
Input Leakage Current	I <sub>LI</sub>	V <sub>CC</sub> = 3.6, V <sub>IN</sub> = GND or V <sub>CC</sub>		10	μA
Output Leakage Current	I <sub>LOx32</sub>	V <sub>CC</sub> = 3.6, V <sub>IN</sub> = GND or V <sub>CC</sub>		10	μA
V <sub>CC</sub> Active Current for Read (1)	I <sub>CC1</sub>	CS# = V <sub>IL</sub> , OE# = V <sub>IH</sub> , f = 5MHz		120	mA
V <sub>CC</sub> Active Current for Program or Erase (2)	I <sub>CC2</sub>	CS# = V <sub>IL</sub> , OE# = V <sub>IH</sub>		140	mA
V <sub>CC</sub> Standby Current	I <sub>CC3</sub>	V <sub>CC</sub> = 3.6, CS = V <sub>IH</sub> , f = 5MHz		200	μA
Output Low Voltage	V <sub>OL</sub>	I <sub>OL</sub> = 5.8 mA, V <sub>CC</sub> = 3.0		0.45	V
Output High Voltage	V <sub>OHI</sub>	I <sub>OH</sub> = -2.0 mA, V <sub>CC</sub> = 3.0	0.85 x V <sub>CC</sub>		V
Low V <sub>CC</sub> Lock-Out Voltage (4)	V <sub>LKO</sub>		2.3	2.5	V

NOTES:

- The I<sub>CC</sub> current listed includes both the DC operating current and the frequency dependent component (at 5 MHz). The frequency component typically is less than 8 mA/MHz, with OE# at V<sub>IH</sub>.
- I<sub>CC</sub> active while Embedded Algorithm (program or erase) is in progress.
- DC test conditions: V<sub>IL</sub> = 0.3V, V<sub>IH</sub> = V<sub>CC</sub> - 0.3V
- Guaranteed by design, but not tested.



AC CHARACTERISTICS – WRITE/ERASE/PROGRAM OPERATIONS – CS# CONTROLLED

V<sub>CC</sub> = 3.3V, V<sub>SS</sub> = 0V, -55°C ≤ T<sub>A</sub> ≤ +125°C

Parameter	Symbol		-100		-120		-150		Unit
			Min	Max	Min	Max	Min	Max	
Write Cycle Time	t <sub>AVAV</sub>	t <sub>WC</sub>	100		120		150		ns
Write Enable Setup Time	t <sub>WLEL</sub>	t <sub>WS</sub>	0		0		0		ns
Chip Select Pulse Width	t <sub>LEH</sub>	t <sub>CP</sub>	45		50		50		ns
Address Setup Time	t <sub>AVEL</sub>	t <sub>AS</sub>	0		0		0		ns
Data Setup Time	t <sub>DVEH</sub>	t <sub>DS</sub>	45		50		50		ns
Data Hold Time	t <sub>EHDX</sub>	t <sub>DH</sub>	0		0		0		ns
Address Hold Time	t <sub>ELAX</sub>	t <sub>AH</sub>	45		50		50		ns
Chip Select Pulse Width High	t <sub>EHEL</sub>	t <sub>CPH</sub>	20		20		20		ns
Duration of Byte Programming Operation (1)	t <sub>WHWH1</sub>			300		300		300	μs
Sector Erase Time	t <sub>WHWH2</sub>			15		15		15	sec
Read Recovery Time (2)	t <sub>GHEL</sub>		0		0		0		μs
Chip Programming Time				50		50		50	sec

1. Typical value for t<sub>WHWH1</sub> is 9μs.
2. Guaranteed by design, but not tested.

AC TEST CIRCUIT

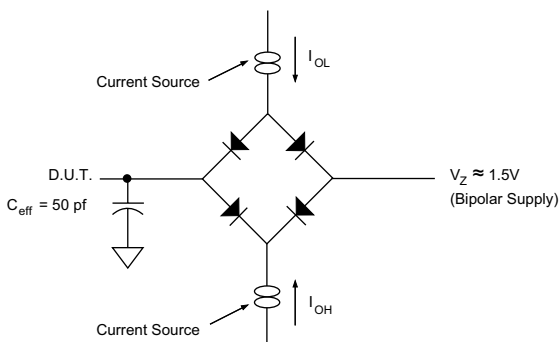

AC TEST CONDITIONS

Parameter	Typ	Unit
Input Pulse Levels	V <sub>IL</sub> = 0, V <sub>IH</sub> = 2.5	V
Input Rise and Fall	5	ns
Input and Output Reference Level	1.5	V
Output Timing Reference Level	1.5	V

NOTES:  
 V<sub>Z</sub> is programmable from -2V to +7V.  
 I<sub>OL</sub> & I<sub>OH</sub> programmable from 0 to 16mA.  
 Tester Impedance Z<sub>0</sub> = 75 Ω.  
 V<sub>Z</sub> is typically the midpoint of V<sub>OH</sub> and V<sub>OL</sub>.  
 I<sub>OL</sub> & I<sub>OH</sub> are adjusted to simulate a typical resistive load circuit.  
 ATE tester includes jig capacitance.



**AC CHARACTERISTICS – WRITE/ERASE/PROGRAM OPERATIONS – WE# CONTROLLED**

V<sub>CC</sub> = 3.3V, V<sub>SS</sub> = 0V, -55°C ≤ T<sub>A</sub> ≤ +125°C

Parameter	Symbol		-100		-120		-150		Unit
			Min	Max	Min	Max	Min	Max	
Write Cycle Time	t <sub>AVAV</sub>	t <sub>WC</sub>	100		120		150		ns
Chip Select Setup Time	t <sub>ELWL</sub>	t <sub>CS</sub>	0		0		0		ns
Write Enable Pulse Width	t <sub>WLWH</sub>	t <sub>WP</sub>	50		50		65		ns
Address Setup Time	t <sub>AVWL</sub>	t <sub>AS</sub>	0		0		0		ns
Data Setup Time	t <sub>DVWH</sub>	t <sub>DS</sub>	50		50		65		ns
Data Hold Time	t <sub>WHDX</sub>	t <sub>DH</sub>	0		0		0		ns
Address Hold Time	t <sub>WLAX</sub>	t <sub>AH</sub>	50		50		65		ns
Write Enable Pulse Width High	t <sub>WHWL</sub>	t <sub>WPH</sub>	30		30		35		ns
Duration of Byte Programming Operation (1)	t <sub>WHWH1</sub>			300	300		300		μs
Sector Erase	t <sub>WHWH2</sub>			15	15		15		sec
Read Recovery Time before Write (3)	t <sub>GHWL</sub>		0		0		0		μs
VCC Setup Time	t <sub>VCS</sub>		50		50		50		μs
Chip Programming Time				50		50		50	sec
Output Enable Setup Time	t <sub>OES</sub>		0		0		0		ns
Output Enable Hold Time (2)	t <sub>OEH</sub>		10		10		10		ns

1. Typical value for t<sub>WHWH1</sub> is 9μs.
2. For Toggle and Data Polling.
3. Guaranteed by design, but not tested.

**AC CHARACTERISTICS – READ-ONLY OPERATIONS**

V<sub>CC</sub> = 3.3V, V<sub>SS</sub> = 0V, -55°C ≤ T<sub>A</sub> ≤ +125°C

Parameter	Symbol		-100		-120		-150		Unit
			Min	Max	Min	Max	Min	Max	
Read Cycle Time	t <sub>AVAV</sub>	t <sub>RC</sub>	100		120		150		ns
Address Access Time	t <sub>AVQV</sub>	t <sub>ACC</sub>		100		120		150	ns
Chip Select Access Time	t <sub>ELQV</sub>	t <sub>CE</sub>		100		120		150	ns
Output Enable to Output Valid	t <sub>GLQV</sub>	t <sub>OE</sub>		40		50		55	ns
Chip Select High to Output High Z (1)	t <sub>EHQZ</sub>	t <sub>DF</sub>		30		30		40	ns
Output Enable High to Output High Z (1)	t <sub>GHQZ</sub>	t <sub>DF</sub>		30		30		40	ns
Output Hold from Addresses, CS# or OE# Change, whichever is First	t <sub>AXQX</sub>	t <sub>OH</sub>	0		0		0		ns

1. Guaranteed by design, not tested.



**AC WAVEFORMS FOR READ OPERATIONS**

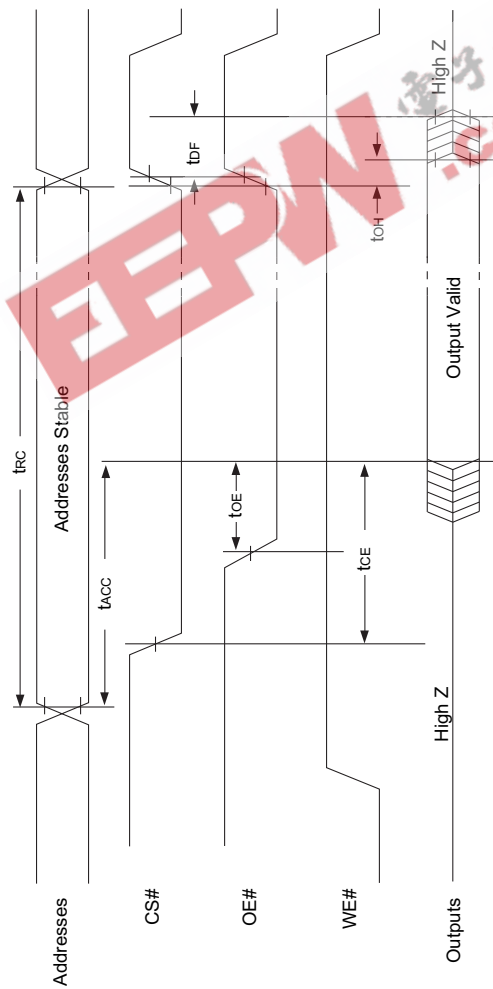



WRITE/ERASE/PROGRAM OPERATION, WE# CONTROLLED

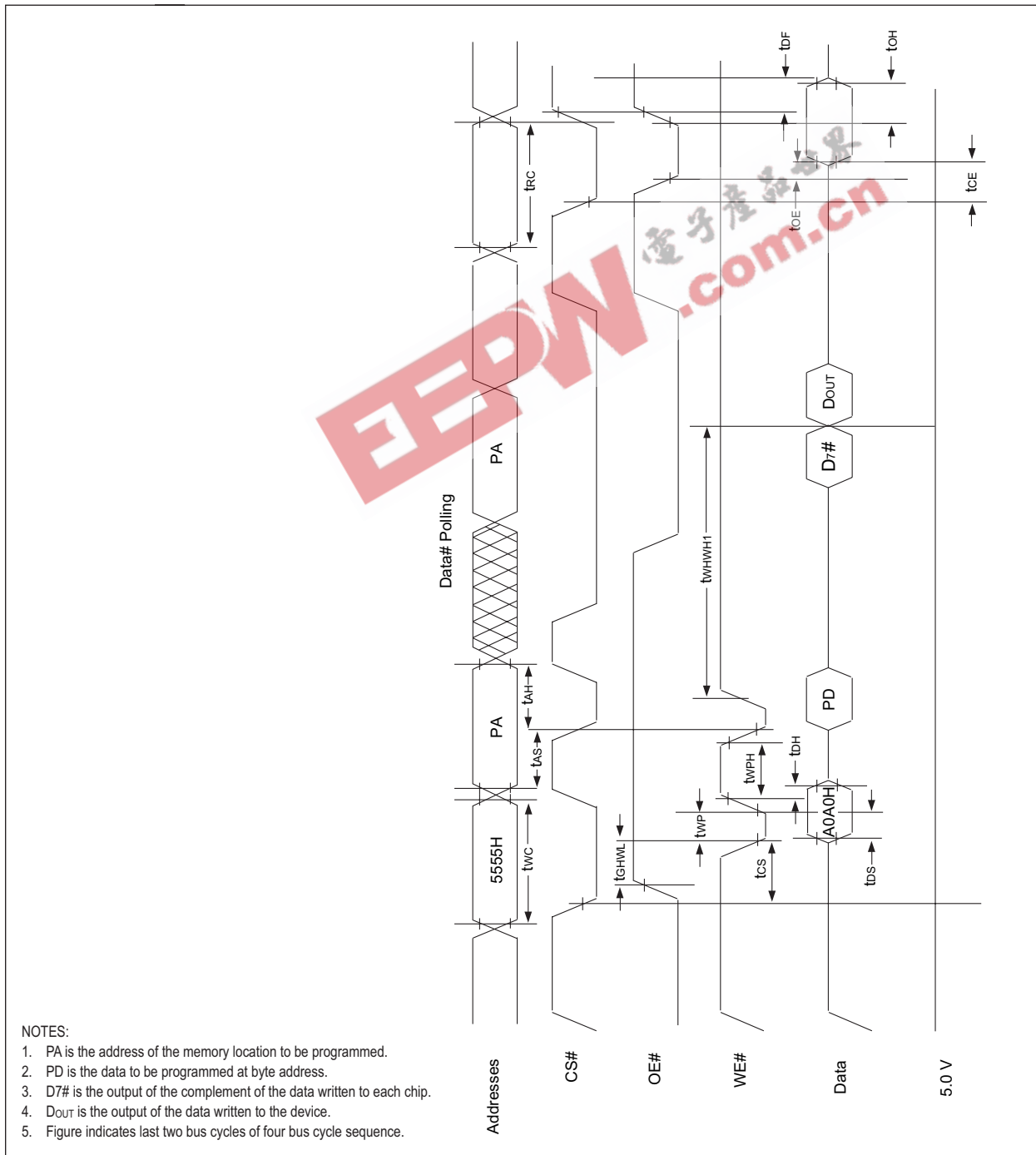



AC WAVEFORMS CHIP/SECTOR ERASE OPERATIONS

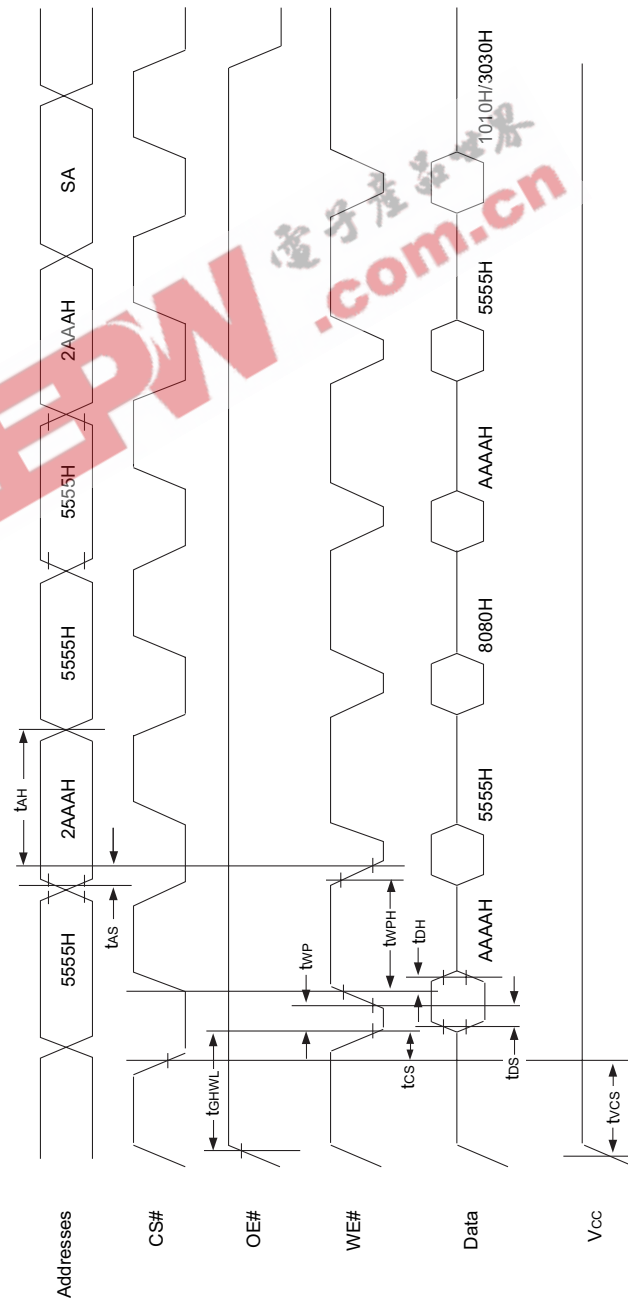

NOTE:

- 1. SA is the sector address for Sector Erase.





AC WAVEFORMS FOR DATA# POLLING DURING EMBEDDED ALGORITHM OPERATIONS

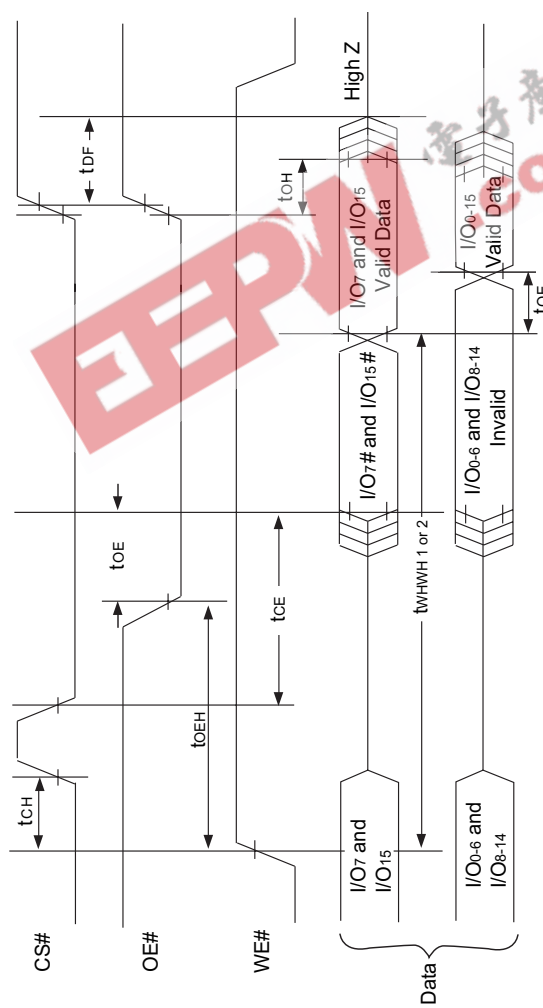



ALTERNATE CS# CONTROLLED PROGRAMMING OPERATION TIMINGS

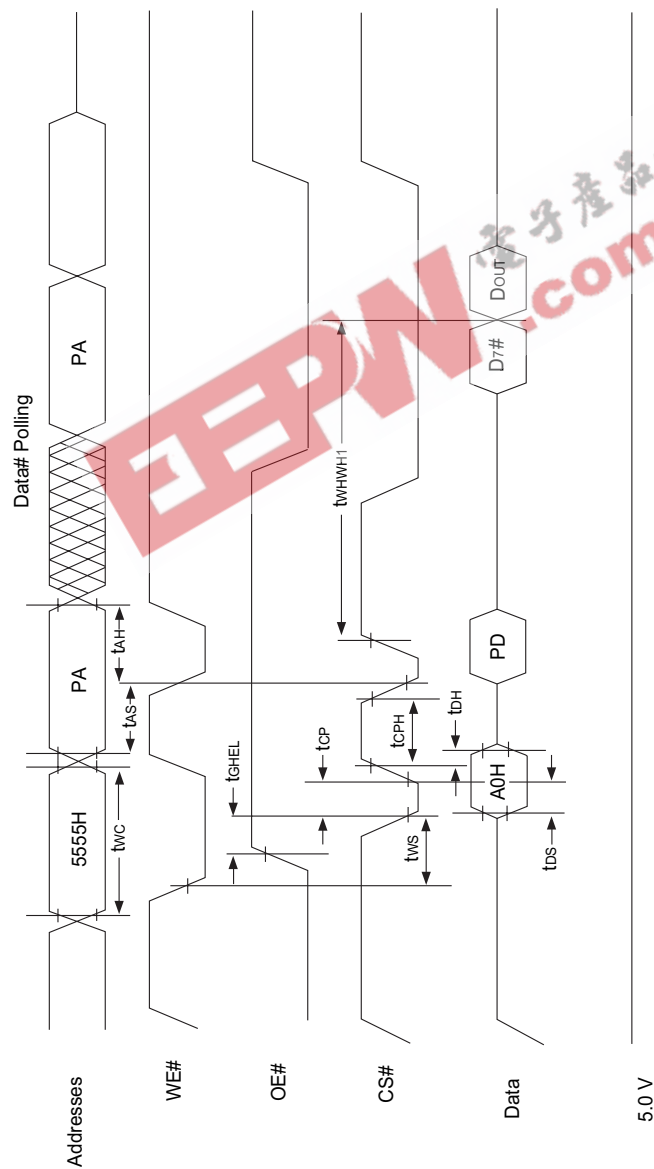

NOTES:

1. PA represents the address of the memory location to be programmed.
2. PD represents the data to be programmed at byte address.
3. D7# is the output of the complement of the data written to each chip.
4. DOUT is the output of the data written to the device.
5. Figure indicates the last two bus cycles of a four bus cycle sequence.



PACKAGE 509: 68 LEAD, CERAMIC QUAD FLAT PACK, CQFP (G2T)

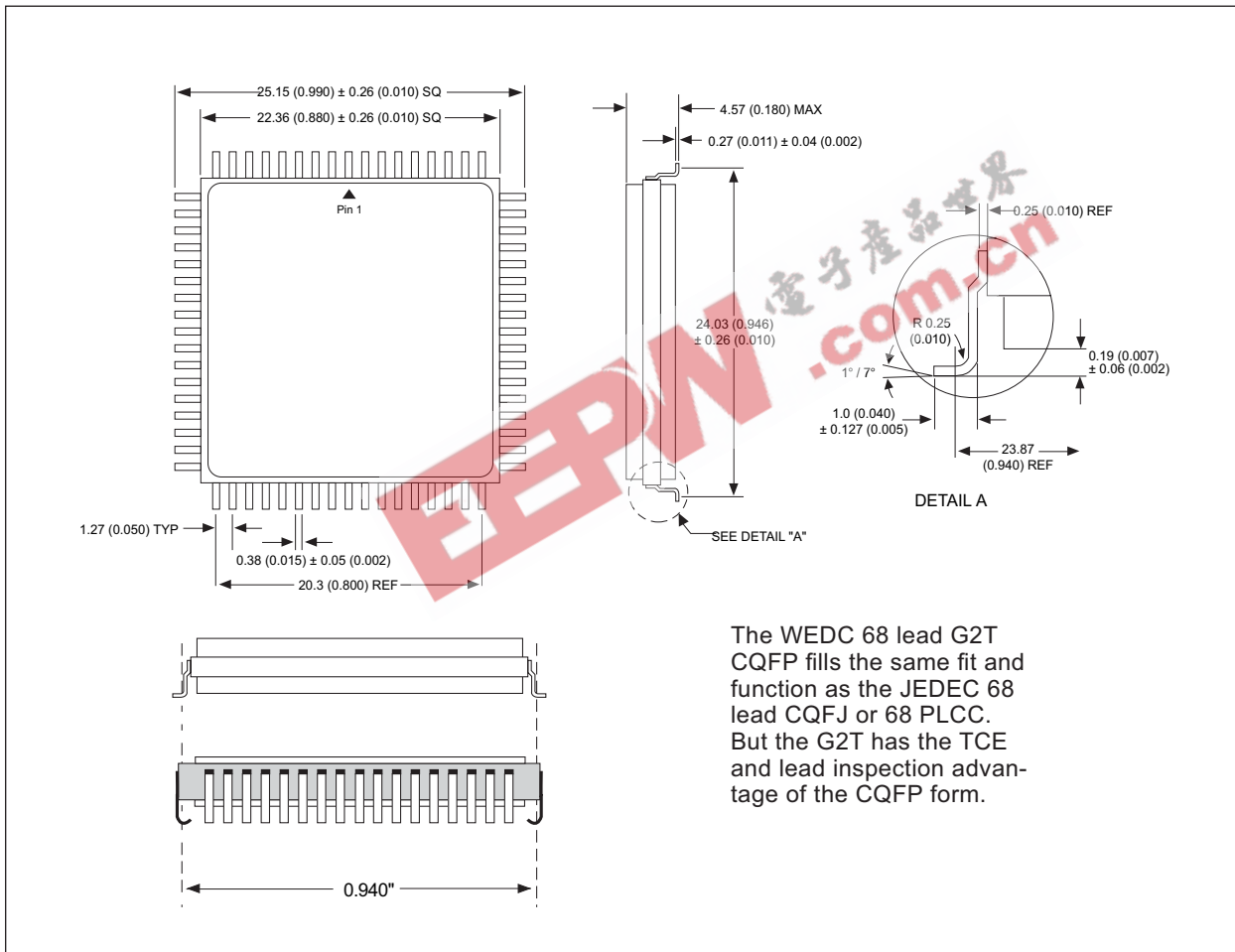

The WEDC 68 lead G2T CQFP fills the same fit and function as the JEDEC 68 lead CQFJ or 68 PLCC. But the G2T has the TCE and lead inspection advantage of the CQFP form.

ALL LINEAR DIMENSIONS ARE MILLIMETERS AND PARENTHETICALLY IN INCHES



**PACKAGE 401: 66 PIN, PGA TYPE, CERAMIC HEX-IN-LINE PACKAGE, HIP (H1)**

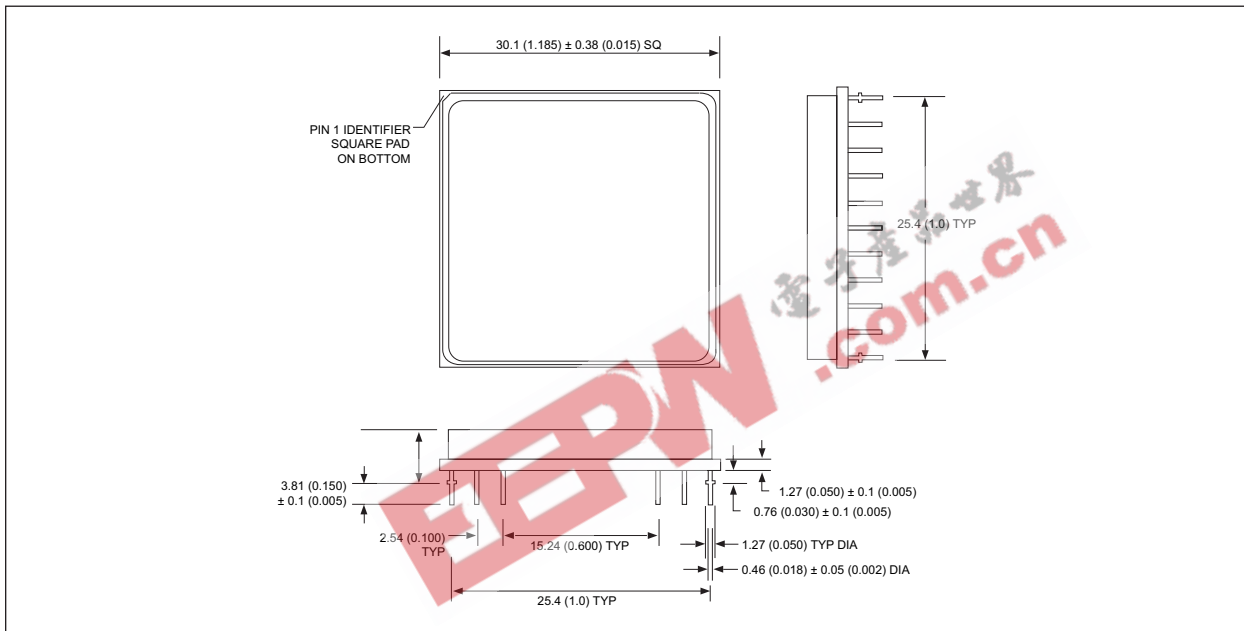

ALL LINEAR DIMENSIONS ARE MILLIMETERS AND PARENTHETICALLY IN INCHES



**ORDERING INFORMATION**

