



## 512Kx8 MONOLITHIC FLASH, SMD 5962-96692

### FEATURES

- Access Times of 70, 90, 120, 150ns
- Packaging
  - 32 pin, Hermetic Ceramic, 0.600" DIP (Package 300)
  - 32 lead, Hermetic Ceramic, 0.400" SOJ (Package 101)
  - 32 pin, Rectangular Ceramic Leadless Chip Carrier (Package 601)
  - 32 lead Flatpack (Package 220)
- 1,000,000 Erase/Program Cycles Minimum
- Sector Erase Architecture
  - 8 equal size sectors of 64K bytes each
  - Any combination of sectors can be concurrently erased. Also supports full chip erase
- Organized as 512Kx8
- Commercial, Industrial and Military Temperature Ranges
- 5 Volt Programming. 5V ±10% Supply.
- Low Power CMOS
- Embedded Erase and Program Algorithms
- TTL Compatible Inputs and CMOS Outputs
- Page Program Operation and Internal Program Control Time.

*Note: For programming information refer to Flash Programming 4M5 Application Note.*

#### PIN CONFIGURATION FOR WMF512K8-XXX5

32 DIP  
32 CSOJ  
32 Flatpack  
TOP VIEW

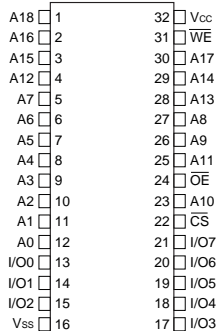

#### PIN CONFIGURATION FOR WMF512K8-XCLX5

32 CLCC  
TOP VIEW

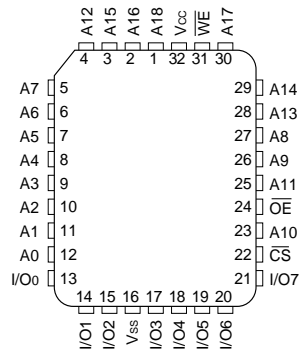

#### PIN DESCRIPTION

A0-18	Address Inputs
I/O0-7	Data Input/Output
CS	Chip Select
OE	Output Enable
WE	Write Enable
Vcc	+5.0V Power
Vss	Ground



**ABSOLUTE MAXIMUM RATINGS (1)**

Parameter		Unit
Operating Temperature	-55 to +125	°C
Supply Voltage (V <sub>CC</sub> ) (1)	-2.0 to +7.0	V
Signal Voltage Range(any pin except A <sub>9</sub> ) (2)	-2.0 to +7.0	V
Storage Temperature Range	-65 to +150	°C
Lead Temperature (soldering, 10 seconds)	+300	°C
Data Retention Mil Temp	20	years
Endurance - erase/program cycles (Mil Temp)	100,000 min	cycles
A <sub>9</sub> Voltage for sector protect (V <sub>ID</sub> ) (3)	-2.0 to +14.0	V

**NOTES:**

1. Stresses above the absolute maximum rating may cause permanent damage to the device. Extended operation at the maximum levels may degrade performance and affect reliability.
2. Minimum DC voltage on input or I/O pins is -0.5V. During voltage transitions, inputs may overshoot V<sub>SS</sub> to -2.0 V for periods of up to 20ns. Maximum DC voltage on output and I/O pins is V<sub>CC</sub> + 0.5V. During voltage transitions, outputs may overshoot to V<sub>CC</sub> + 2.0 V for periods of up to 20ns.
3. Minimum DC input voltage on A<sub>9</sub> pin is -0.5V. During voltage transitions, A<sub>9</sub> may overshoot V<sub>SS</sub> to -2V for periods of up to 20ns. Maximum DC input voltage on A<sub>9</sub> is +13.5V which may overshoot to 14.0 V for periods up to 20ns.

**RECOMMENDED OPERATING CONDITIONS**

Parameter	Symbol	Min	Max	Unit
Supply Voltage	V <sub>CC</sub>	4.5	5.5	V
Input High Voltage	V <sub>IH</sub>	2.0	V <sub>CC</sub> + 0.5	V
Input Low Voltage	V <sub>IL</sub>	-0.5	+0.8	V
Operating Temp. (Mil.)	T <sub>A</sub>	-55	+125	°C
Operating Temp. (Ind.)	T <sub>A</sub>	-40	+85	°C
A <sub>9</sub> Voltage for Sector Protect	V <sub>ID</sub>	11.5	12.5	V

**CAPACITANCE**

(T<sub>A</sub> = +25°C)

Parameter	Symbol	Conditions	Max	Unit
Address Input capacitance	C <sub>AD</sub>	V <sub>I/O</sub> = 0 V, f = 1.0 MHz	15	pF
Output Enable capacitance	C <sub>OE</sub>	V <sub>IN</sub> = 0 V, f = 1.0 MHz	15	pF
Write Enable capacitance	C <sub>WE</sub>	V <sub>IN</sub> = 0 V, f = 1.0 MHz	15	pF
Chip Select capacitance	C <sub>CS</sub>	V <sub>IN</sub> = 0 V, f = 1.0 MHz	15	pF
Data I/O capacitance	C <sub>I/O</sub>	V <sub>I/O</sub> = 0 V, f = 1.0 MHz	15	pF

This parameter is guaranteed by design but not tested.

**DC CHARACTERISTICS - CMOS COMPATIBLE**

(V<sub>CC</sub> = 5.0V, V<sub>SS</sub> = 0V, T<sub>A</sub> = -55°C to +125°C)

Parameter	Symbol	Conditions	Min		Unit
				Max	
Input Leakage Current	I <sub>LI</sub>	V <sub>CC</sub> = 5.5, V <sub>IN</sub> = GND to V <sub>CC</sub>		10	μA
Output Leakage Current	I <sub>LOx32</sub>	V <sub>CC</sub> = 5.5, V <sub>IN</sub> = GND to V <sub>CC</sub>		10	μA
V <sub>CC</sub> Active Current for Read (1)	I <sub>CC1</sub>	$\overline{CS} = V_{IL}, \overline{OE} = V_{IH}, f = 5\text{MHz}$		50	mA
V <sub>CC</sub> Active Current for Program or Erase (2)	I <sub>CC2</sub>	$\overline{CS} = V_{IL}, \overline{OE} = V_{IH}$		60	mA
V <sub>CC</sub> Standby Current	I <sub>CC4</sub>	V <sub>CC</sub> = 5.5, $\overline{CS} = V_{IH}, f = 5\text{MHz}$		1.6	mA
Output Low Voltage	V <sub>OL</sub>	I <sub>OL</sub> = 8.0 mA, V <sub>CC</sub> = 4.5		0.45	V
Output High Voltage	V <sub>OH1</sub>	I <sub>OH</sub> = -2.5 mA, V <sub>CC</sub> = 4.5	0.85 x V <sub>CC</sub>		V
Low V <sub>CC</sub> Lock-Out Voltage	V <sub>LKO</sub>		3.2	4.2	V

**NOTES:**

1. The I<sub>CC</sub> current listed includes both the DC operating current and the frequency dependent component (at 5 MHz). The frequency component typically is less than 2 mA/MHz, with  $\overline{OE}$  at V<sub>IH</sub>.
2. I<sub>CC</sub> active while Embedded Algorithm (program or erase) is in progress.
3. DC test conditions: V<sub>IL</sub> = 0.3V, V<sub>IH</sub> = V<sub>CC</sub> - 0.3V



AC CHARACTERISTICS – WRITE/ERASE/PROGRAM OPERATIONS,  $\overline{CS}$  CONTROLLED

( $V_{CC} = 5.0V, V_{SS} = 0V, T_A = -55^{\circ}C$  to  $+125^{\circ}C$ )

Parameter	Symbol		-70		-90		-120		-150		Unit
			Min	Max	Min	Max	Min	Max			
Write Cycle Time	tAVAV	tWC	70		90		120		150		ns
Write Enable Setup Time	tWLLEL	tWS	0		0		0		0		ns
Chip Select Pulse Width	tELEH	tCP	45		45		50		50		ns
Address Setup Time	tAVEL	tAS	0		0		0		0		ns
Data Setup Time	tDVEH	tDS	45		45		50		50		ns
Data Hold Time	tEHDX	tDH	0		0		0		0		ns
Address Hold Time	tELAX	tAH	45		45		50		50		ns
Chip Select Pulse Width High	tEHEL	tCPH	20		20		20		20		ns
Duration of Byte Programming Operation (1)	tWHWH1			300		300		300		300	$\mu$ s
Sector Erase Time (2)	tWHWH2			15		15		15		15	sec
Read Recovery Time	tGHEL		0		0		0		0		ns
Chip Programming Time				11		11		11		11	sec
Chip Erase Time (3)				64		64		64		64	sec

NOTES:

1. Typical value for tWHWH1 is 7 $\mu$ s.
2. Typical value for tWHWH2 is 1sec.
3. Typical value for Chip Erase time is 8sec.

AC TEST CIRCUIT

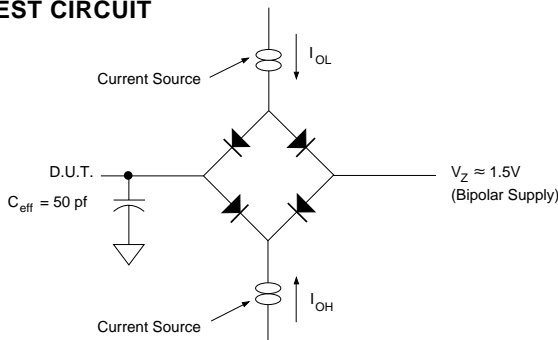

AC TEST CONDITIONS

Parameter	Typ	Unit
Input Pulse Levels	$V_{IL} = 0, V_{IH} = 3.0$	V
Input Rise and Fall	5	ns
Input and Output Reference Level	1.5	V
Output Timing Reference Level	1.5	V

NOTES:

- $V_z$  is programmable from -2V to +7V.
- $I_{OL}$  &  $I_{OH}$  programmable from 0 to 16mA.
- Tester Impedance  $Z_0 = 75 \Omega$ .
- $V_z$  is typically the midpoint of  $V_{OH}$  and  $V_{OL}$ .
- $I_{OL}$  &  $I_{OH}$  are adjusted to simulate a typical resistive load circuit.
- ATE tester includes jig capacitance.



**AC CHARACTERISTICS – WRITE/ERASE/PROGRAM OPERATIONS,  $\overline{WE}$  CONTROLLED**

(V<sub>CC</sub> = 5.0V, T<sub>A</sub> = -55°C to +125°C)

Parameter	Symbol		-70		-90		-120		-150		Unit
			Min	Max	Min	Max	Min	Max	Min	Max	
Write Cycle Time	tAVAV	tWC	70		90		120		150		ns
Chip Select Setup Time	tELWL	tCS	0		0		0		0		ns
Write Enable Pulse Width	tWLWH	tWP	45		45		50		50		ns
Address Setup Time	tAVWH	tAS	0		0		0		0		ns
Data Setup Time	tDVWH	tDS	45		45		50		50		ns
Data Hold Time	tWHDX	tDH	0		0		0		0		ns
Address Hold Time	tWHAX	tAH	45		45		50		50		ns
Write Enable Pulse Width High	tWHWL	tWPH	20		20		20		20		ns
Duration of Byte Programming Operation (1)	tWHWH1			300		300		300		300	μs
Sector Erase Time (2)	tWHWH2			15		15		15		15	sec
Read Recovery Time before Write	tGHWL		0		0		0		0		ms
V <sub>CC</sub> Set-up Time		tVCS	50		50		50		50		μs
Chip Programming Time				11		11		11		11	sec
Output Enable Setup Time		tOES	0		0		0		0		ns
Output Enable Hold Time (4)		tOEH	10		10		10		10		ns
Chip Erase Time (3)				64		64		64		64	sec

**NOTES:**

1. Typical value for t<sub>WHWH1</sub> is 7μs.
2. Typical value for t<sub>WHWH2</sub> is 1sec.
3. Typical value for Chip Erase time is 8sec.
4. For Toggle and Data Polling.

**AC CHARACTERISTICS – READ ONLY OPERATIONS**

(V<sub>CC</sub> = 5.0V, T<sub>A</sub> = -55°C to +125°C)

Parameter	Symbol		-70		-90		-120		-150		Unit
			Min	Max	Min	Max	Min	Max	Min	Max	
Read Cycle Time	tAVAV	tRC	70		90		120		150		ns
Address Access Time	tAVOV	tACC		70		90		120		150	ns
Chip Select Access Time	tELQV	tCE		70		90		120		150	ns
Output Enable to Output Valid	tGLOV	tOE		35		35		50		55	ns
Chip Select to Output High Z (1)	tEHQZ	tDF		20		20		30		35	ns
Output Enable High to Output High Z (1)	tGHQZ	tDF		20		20		30		35	ns
Output Hold from Address, $\overline{CS}$ or $\overline{OE}$ Change, whichever is First	tAXOX	tOH	0		0		0		0		ns

**NOTES:**

1. Guaranteed by design, but not tested



AC WAVEFORMS FOR READ OPERATIONS

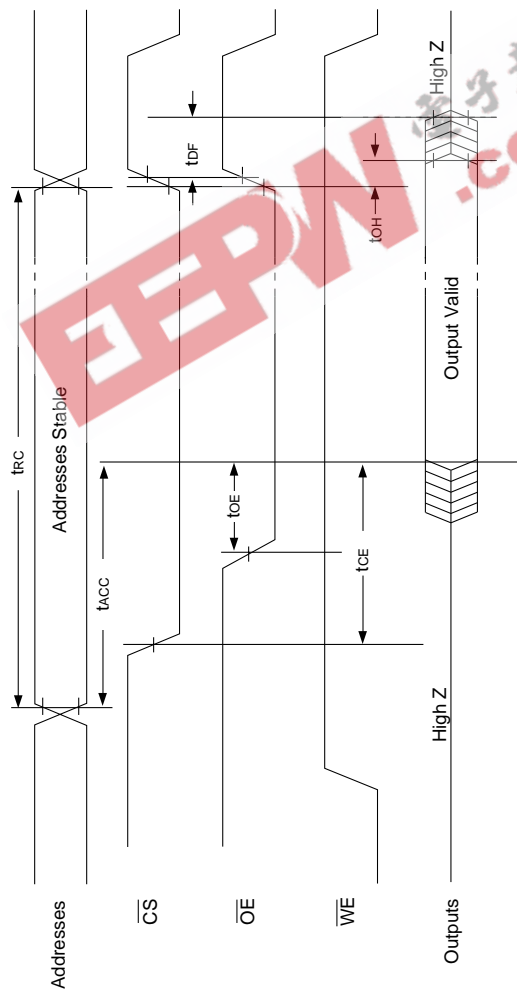



**WRITE/ERASE/PROGRAM  
OPERATION, WE CONTROLLED**

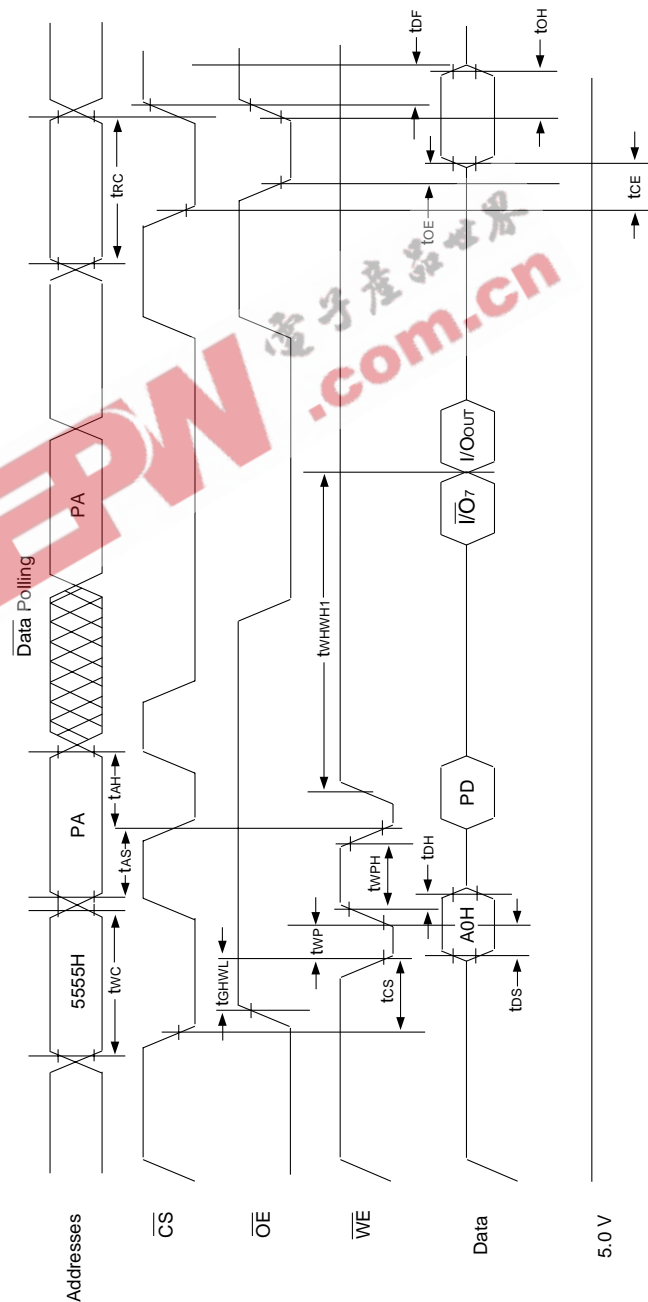

**NOTES:**

1. PA is the address of the memory location to be programmed.
2. PD is the data to be programmed at byte address.
3. I/O is the output of the complement of the data written to the device.
4. I/Oout is the output of the data written to the device.
5. Figure indicates last two bus cycles of four bus cycle sequence.



AC WAVEFORMS CHIP/SECTOR ERASE OPERATIONS

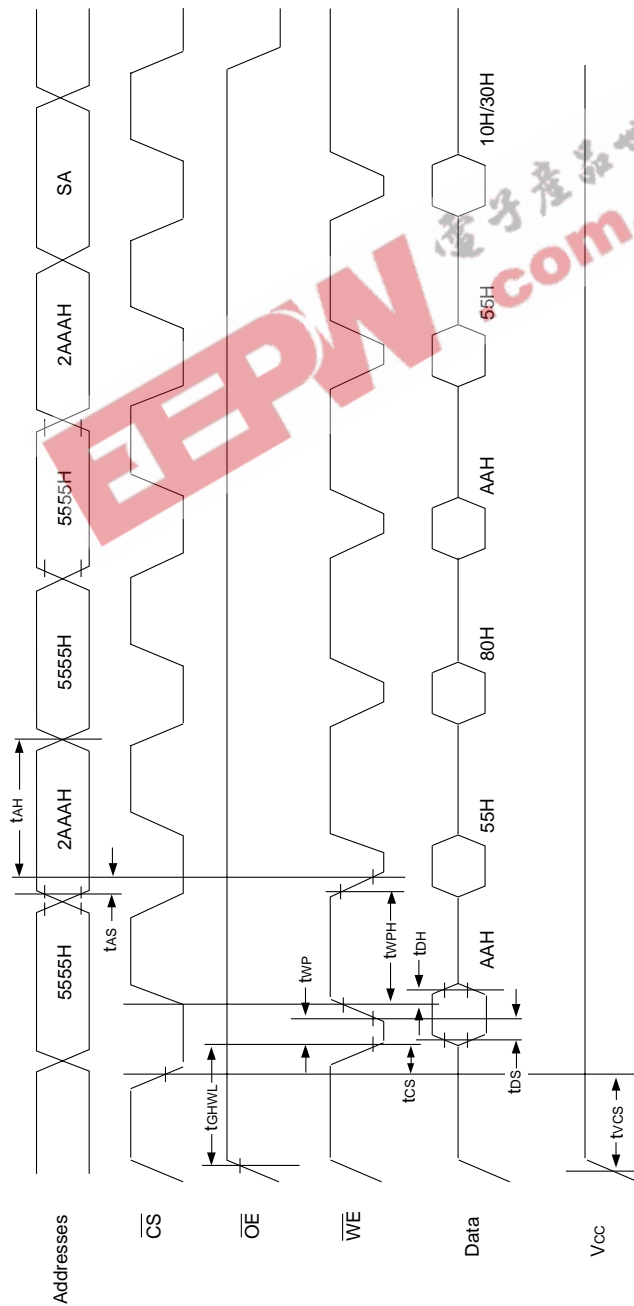

NOTES:  
1. SA is the Sector Address for Sector Erase.



AC WAVEFORMS FOR DATA POLLING  
DURING EMBEDDED ALGORITHM OPERATIONS

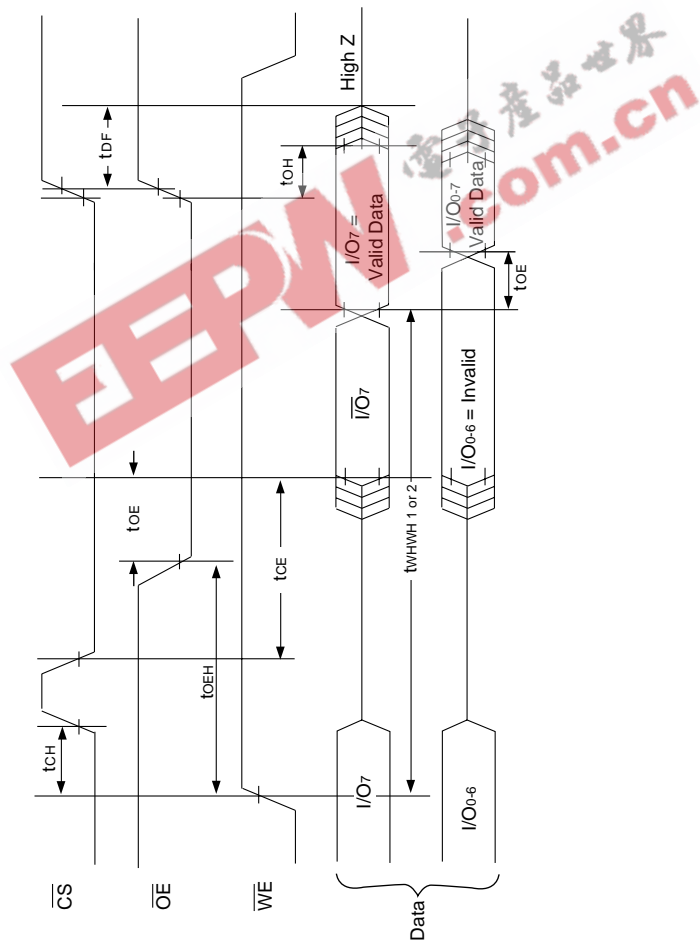





ALTERNATE  $\overline{CS}$  CONTROLLED PROGRAMMING OPERATION TIMINGS

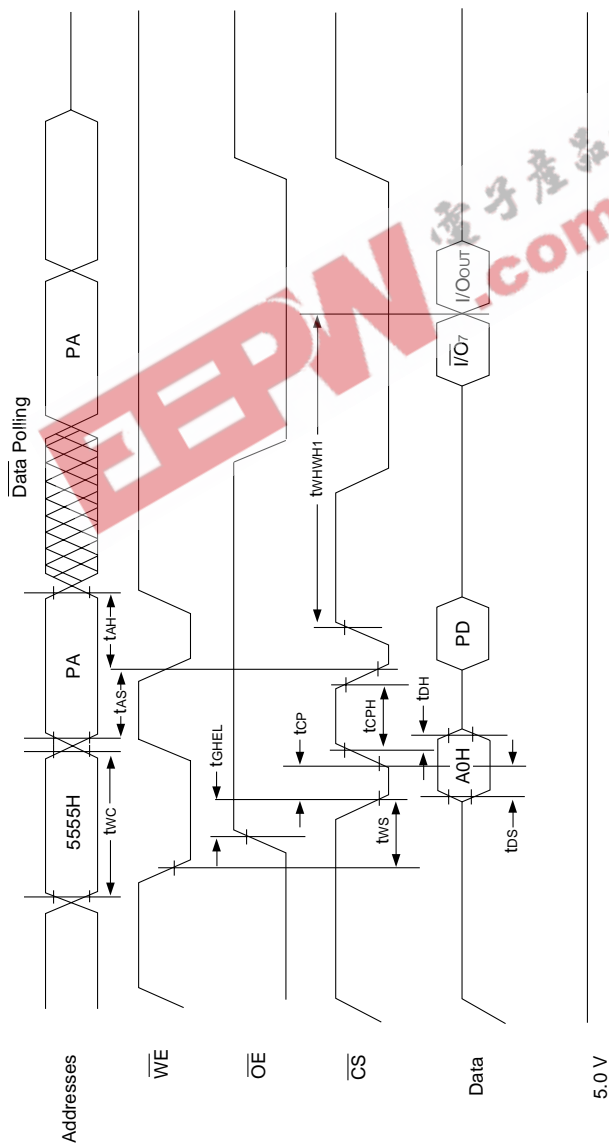

NOTES:

- 1. PA represents the address of the memory location to be programmed.
- 2. PD represents the data to be programmed at byte address.
- 3.  $\overline{I/O}$  is the output of the complement of the data written to the device.
- 4. I/Oout is the output of the data written to the device.
- 5. Figure indicates the last two bus cycles of a four bus cycle sequence.



**PACKAGE 101: 32 LEAD, CERAMIC SOJ**

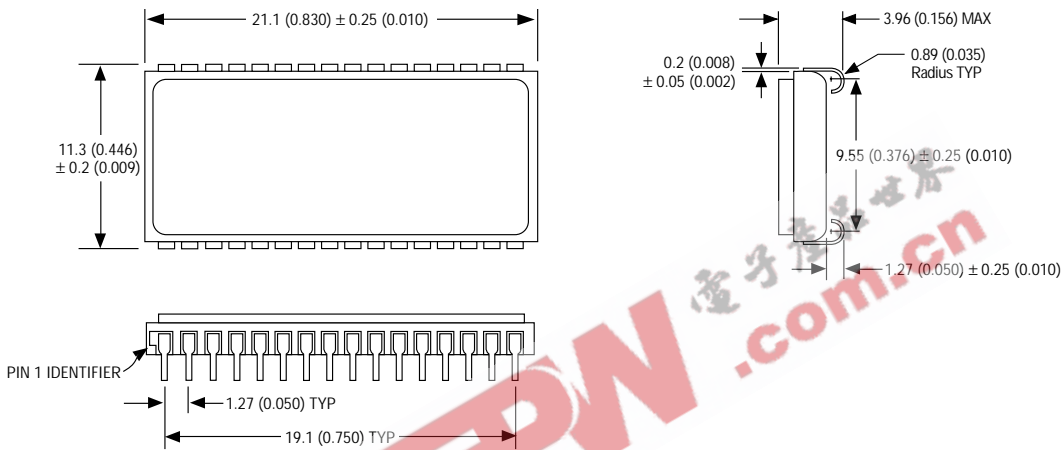

ALL LINEAR DIMENSIONS ARE MILLIMETERS AND PARENTHETICALLY IN INCHES

**PACKAGE 220: 32 LEAD, CERAMIC FLATPACK**

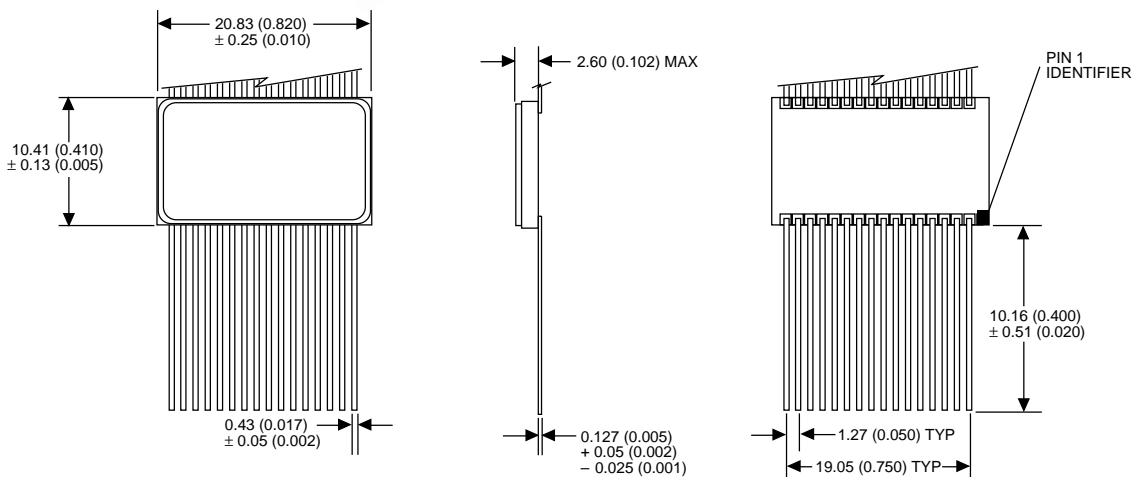

ALL LINEAR DIMENSIONS ARE MILLIMETERS AND PARENTHETICALLY IN INCHES



PACKAGE 300: 32 PIN, CERAMIC DIP, SINGLE CAVITY SIDE BRAZED

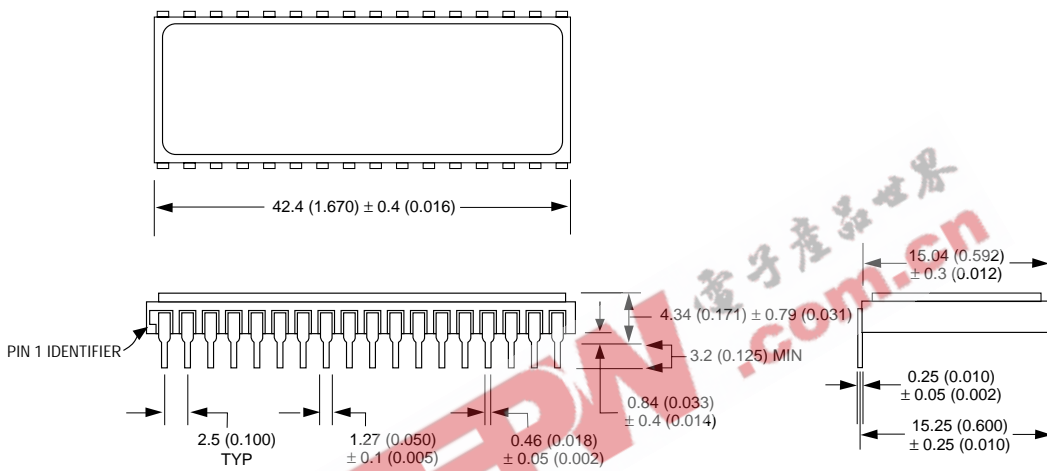

ALL LINEAR DIMENSIONS ARE MILLIMETERS AND PARENTHETICALLY IN INCHES



PACKAGE 601: 32 PIN, RECTANGULAR CERAMIC LEADLESS CHIP CARRIER

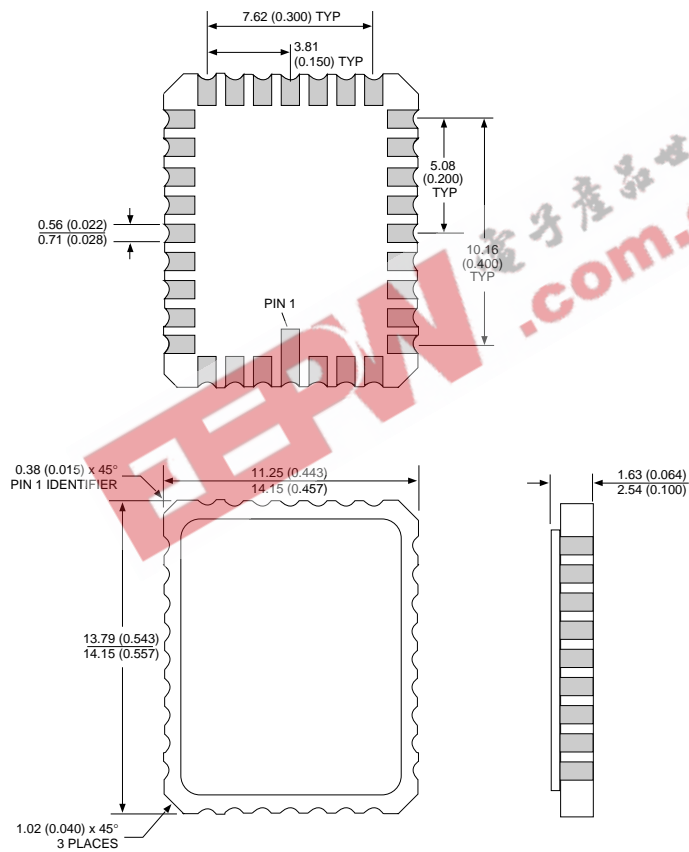

ALL LINEAR DIMENSIONS ARE MILLIMETERS AND PARENTHETICALLY IN INCHES



**ORDERING INFORMATION**

**W M F 512K 8 - XXX X X 5 X**

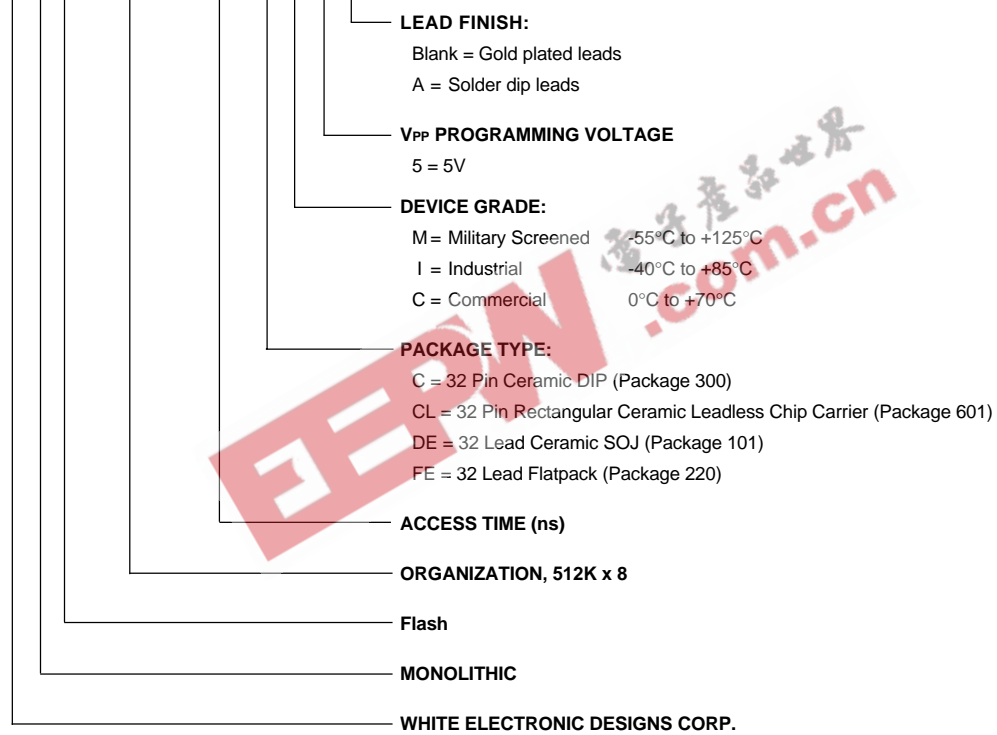

DEVICE TYPE	SECTOR SIZE	SPEED	PACKAGE	SMD NO.
512K x 8 Flash Monolithic	64KByte	150ns	32 pin DIP (C)	5962-96692 01HXX
512K x 8 Flash Monolithic	64KByte	120ns	32 pin DIP (C)	5962-96692 02HXX
512K x 8 Flash Monolithic	64KByte	90ns	32 pin DIP (C)	5962-96692 03HXX
512K x 8 Flash Monolithic	64KByte	70ns	32 pin DIP (C)	5962-96692 04HXX
512K x 8 Flash Monolithic	64KByte	150ns	32 lead SOJ (DE)	5962-96692 01HYX
512K x 8 Flash Monolithic	64KByte	120ns	32 lead SOJ (DE)	5962-96692 02HYX
512K x 8 Flash Monolithic	64KByte	90ns	32 lead SOJ (DE)	5962-96692 03HYX
512K x 8 Flash Monolithic	64KByte	70ns	32 lead SOJ (DE)	5962-96692 04HYX
512K x 8 Flash Monolithic	64KByte	150ns	32 lead Flatpack (FE)	5962-96692 01HUX
512K x 8 Flash Monolithic	64KByte	120ns	32 lead Flatpack (FE)	5962-96692 02HUX
512K x 8 Flash Monolithic	64KByte	90ns	32 lead Flatpack (FE)	5962-96692 03HUX
512K x 8 Flash Monolithic	64KByte	70ns	32 lead Flatpack (FE)	5962-96692 04HUX