

Compact Flameproof Power Wirewound Resistors

WP-S Series

- Small size for power rating
- Enhanced pulse handling capability
- Flameproof protection
- SMD Z-form available
- RoHS compliant with Pb-free terminations

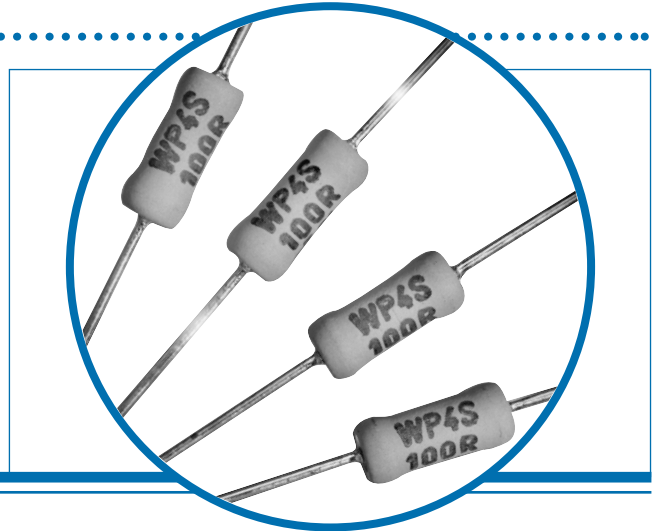

Electrical Data

		WP1S	WP2S	WP25S	WP3S	WP4S	WP5S	WP7S
Power rating at 25°C	watts	1	2	2.5	3	4	5	7
5s overload rating at 25°C	watts	5	10	12.5	15	20	25	35
Short pulse performance		See Pulse Performance graphs						
Resistance range	ohms	R068 to 430R	R05 to 900R	R05 to 900R	R01 to 2K2	R01 to 10K	R015 to 6K8	R15 to 10K
Limiting element voltage	volts	50	50	75	100	100	150	150
TCR	ppm/°C	<1R: 350 ≥1R: 200						
Isolation Voltage	volts	250		350		500		700
Resistance Tolerance	%	<20R: 5 ≥20R: 1, 2, 5		<R10: 5 ≥R10: 1, 2, 5		<20R: 5 ≥20R: 1, 2, 5		
Standard Values		E24 preferred						
Thermal Impedance	°C/watt	140	110	90	82	62	54	35
Ambient temperature range	°C	-55 to +155						

Physical Data

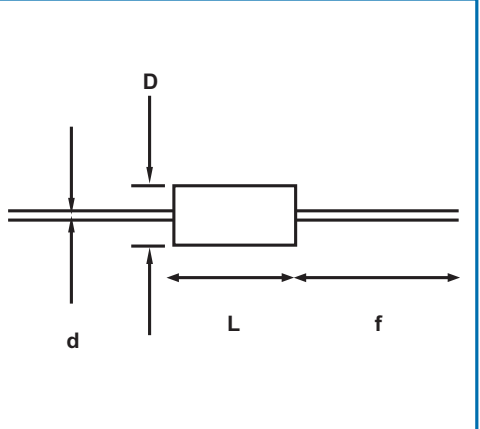
Dimensions (mm) & Weight (g)								
Type	L max	D max	f min	d nom	PCB mount centres	Min bend radius	Wt. nom	
WP1S	6.2	2.8	21.20	0.6	10.20	0.6	0.22	
WP2S	9.0	3.6	19.80	0.8	12.70	1.2	0.50	
WP25S	12.5	4.5	17.80		18.40		0.50	
WP3S	14.5	5.2	24.55		20.30		1.10	
WP4S	13	5.6	22.75		18.90		1.00	
WP5S	16.5	7.0	23.55		22.86		1.75	
WP7S	25.0	8.8	28.30		31.40		4.40	

Construction

A high purity ceramic substrate is assembled with interference fit end caps to which are welded the terminations. The resistive element is wound on the substrate and welded to the caps. Flameproof silicone cement coating is applied prior to marking with indelible ink. The components are then leadformed if required and packed.

General Note

Welwyn Components reserves the right to make changes in product specification without notice or liability. All information is subject to Welwyn's own data and is considered accurate at time of going to print.

Compact Flameproof Power Wirewound Resistors

WP-S Series



Terminations

Material: Hot tin dipped copper wire
 Strength: The terminations meet the requirements of IEC 68.2.21
 Solderability: The terminations meet the requirements of IEC 115-1 Clause 4.17.3.2

Marking

WP1S, WP2S, WP25S and WP3S resistors R10 and above are marked with four or five colour bands in conformance with IEC62. Values below R10 are marked with three bands (two digits indicating value in milliohms, and tolerance); there is no multiplier band. WP4S, WP5S and WP7S resistors are legend marked with type reference, resistance value and tolerance.

Solvent Resistance

The body protection and marking are resistant to all normal industrial cleaning solvents suitable for printed circuits.

Flammability

The resistor coating will not burn or emit incandescent particles under any condition of applied temperature or power overload.

Performance Data

		Maximum	Typical Change
Load at rated power: 1000hrs @ 25°C	ΔR%	5 +0.001Ω	3
Dry heat: 1000hrs @ 200°C	ΔR%	5 +0.001Ω	3
Short term overload (5 x Pr for 5s)	ΔR%	5 +0.001Ω	1
Derating from rated power @25°C		Zero at 280°C	
Climatic	ΔR%	5 +0.001Ω	2
Climatic category		55/200/56	
TRC & Vibration	ΔR%	5 +0.001Ω	1
Robustness & solder heat	ΔR%	5 +0.001Ω	1
Long term damp heat (56 days)	ΔR%	5 +0.001Ω	1

Pulse Performance





The pulse energy capacity limits in the graph below relate to pulses below 100ms duration, low mean power dissipation and at 25°C.

WP-S Short Pulse Energy Capacity

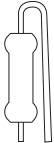
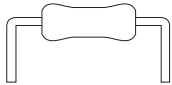
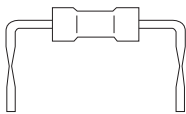

Application Notes

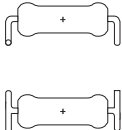
1. If the resistors are to dissipate full rated power, it is recommended that the terminations should not be soldered closer than 4mm from the body.
2. Due to operating temperature limits imposed by some PCB materials, derating may be necessary. An estimate of the temperature rise to be expected at the center of the body can be calculated using the thermal impedance figures given under Electrical Data.
3. WP-S resistors can also be supplied with radial, goalpost or lancet pre-formed leads. WP2S, WP3S, WP4S and WP5S are also available in an SMD format with Z formed leads and packed in blister tape. Consult factory for details.

Radial	Goalpost	Lancet	Z-form
		 	 

Packaging

The standard packaging for WP-S is taped. The critical dimensions are shown in Figure 1. The component wires will not protrude beyond the outside edge of the tapes. Taped product is then packed into boxes or onto reels; see Ordering Procedure for details. Alternative packaging is available by request. Pre-formed resistors are supplied loose packed in plastic bags or boxes.

Dimensions (mm)	b	c
WP1S	52	5
WP2S	52	5
WP25S	52	5
WP3S	67	10
WP4S	63	10
WP5S	63	10
WP7S	85	10

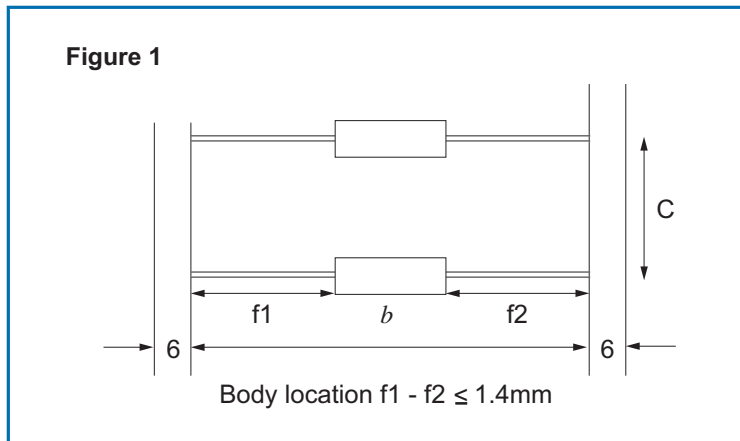

Compact Flameproof Power Wirewound Resistors

WP-S Series

Ordering Procedure

Example: WP2S at 680 ohms and 5% tolerance in ammo pack box of 2500 pieces -

Type **WP2S** - **680R** **J** **A25**

Value (use IEC 62 code)

Tolerance (use IEC 62 code)

F	1%
G	2%
J	5%

Packing

A5	Ammo	WP1S	5000/box	Standard
A25		WP2S	2500/box	
A15		WP25S	1500/box	
A1		WP3S	1000/box	
A1		WP4S	1000/box	
T075	Tape	WP5S	700/reel	
T07		WP7S	700/reel	

