

Sharma Potentiometers

WIW3362 Trimmer Potentiometer

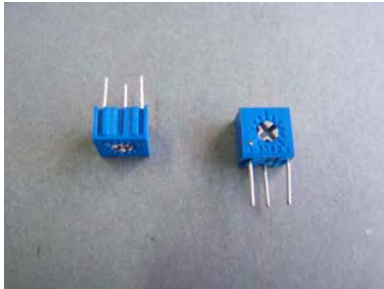

Features

- 6mm Single Turn
- Cermet / Industrial / Sealed
- Top and side adjust types
(P,U, W,S most popular)

Electrical Characteristics

Standard Resistance Range
100 to 2 Megohms
(see standard resistance table)
Resistance Tolerance: $\pm 10\%$ std.
(tighter tolerance available)
Absolute Minimum Resistance:
1% or 2 ohms max.
(whichever is greater)
Contact Resistance Variation
3% or 3 ohms max.
(whichever is greater)
Adjustability
Voltage $\pm 0.05\%$
Resistance $\pm 0.15\%$
Resolution: Infinite
Insulation Resistance
500 vdc
1,000 Megohms min.
Dielectric Strength
101.3 kPa 500 vac
8.5 kPa 315 vac
Adjustment Angle: 210° nom.

Environmental Characteristics

Power Rating (250 volts max.)
0.5 watt (70°C), 0 watt (125°C)
Temperature Range
 -55°C to $+125^\circ\text{C}$
Temperature Coefficient: $\pm 100\text{ppm}/^\circ\text{C}$
Vibration: 98 m/s^2
(1% Δ TR; 2% Δ VR)
Shock: 390 m/s^2
(1% Δ TR; 1% Δ VR)
Load Life
1,000 hours 0.5 watt @ 70°C
(3% Δ TR; 4% or 4 ohm)
Rotational Life: 200 cycles
(3% Δ TR; 4% or 4 ohm.)

Physical Characteristics

Mechanical Angle
 250° nom.
Torque
20 mN • m max.
Stop Strength
50 mN • m min.
Terminals
Solderable pins
Standard Packaging
50 pcs. per tube

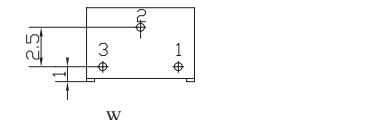
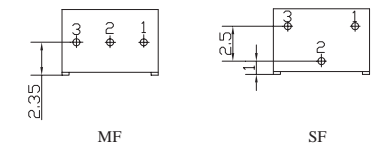
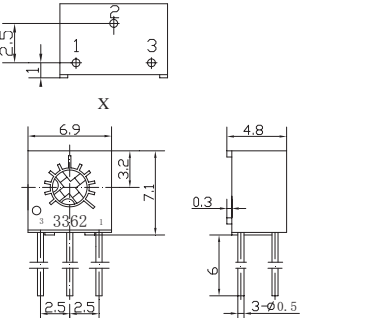
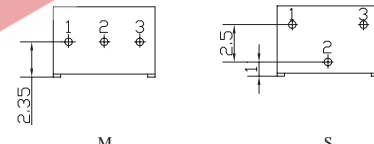
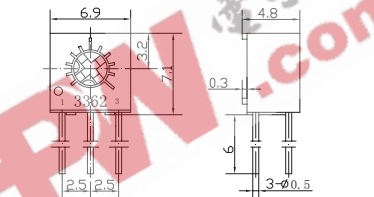
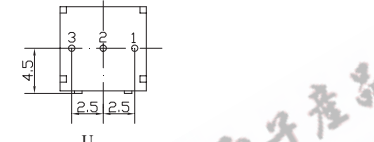
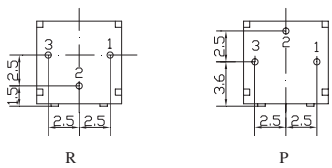
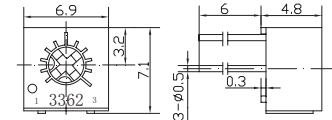

How to order

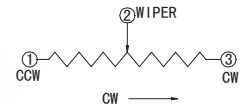
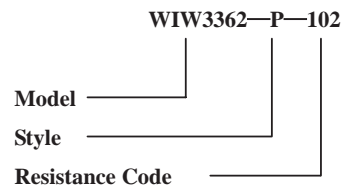

Standard Resistance Table

Resistance (Ohms)	Resistance Code
100	101
200	201
500	501
1,000	102
2,000	202
5,000	502
10,000	103
20,000	203
25,000	253
50,000	503
100,000	104
200,000	204
250,000	254
500,000	504
1,000,000	105
2,000,000	205

Special resistance available

Detail Specification: Q/Ry260A-2000