

Part Number: WP113EDT

Orange

Features

- LOW POWER CONSUMPTION.
- RELIABLE AND RUGGED.
- EXCELLENT UNIFORMITY OF LIGHT OUTPUT.
- SUITABLE FOR LEVEL INDICATOR.
- LONG LIFE - SOLID STATE RELIABILITY.
- RoHS COMPLIANT.

Description

The Orange source color devices are made with Gallium Arsenide Phosphide on Gallium Phosphide Orange Light Emitting Diode.

Package Dimensions

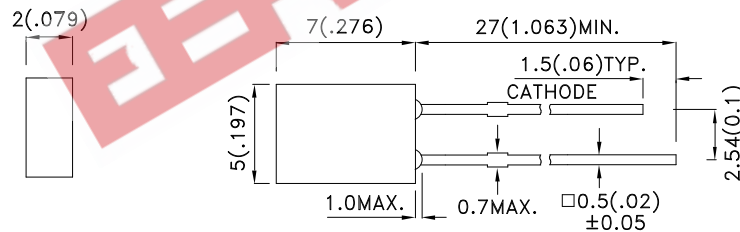

Notes:

1. All dimensions are in millimeters (inches).
2. Tolerance is $\pm 0.25(0.01)$ " unless otherwise noted.
3. Lead spacing is measured where the leads emerge from the package.
4. Specifications are subject to change without notice.



Selection Guide

Part No.	Dice	Lens Type	Iv (mcd) [2] @ 10mA		Viewing Angle [1]
			Min.	Typ.	2θ1/2
WP113EDT	Orange (GaAsP/GaP)	ORANGE DIFFUSED	3	5	110°

Notes:

1. θ1/2 is the angle from optical centerline where the luminous intensity is 1/2 the optical centerline value.
2. Luminous intensity/ luminous Flux: +/-15%.

Electrical / Optical Characteristics at TA=25°C

Symbol	Parameter	Device	Typ.	Max.	Units	Test Conditions
λ _{peak}	Peak Wavelength	Orange	627		nm	I _F =20mA
λ _D [1]	Dominant Wavelength	Orange	625		nm	I _F =20mA
Δλ _{1/2}	Spectral Line Half-width	Orange	45		nm	I _F =20mA
C	Capacitance	Orange	15		pF	V _F =0V;f=1MHz
V _F [2]	Forward Voltage	Orange	2	2.5	V	I _F =20mA
I _R	Reverse Current	Orange		10	uA	V _R = 5V

Notes:

1. Wavelength: +/-1nm.
2. Forward Voltage: +/-0.1V.

Absolute Maximum Ratings at TA=25°C

Parameter	Orange	Units
Power dissipation	75	mW
DC Forward Current	30	mA
Peak Forward Current [1]	160	mA
Reverse Voltage	5	V
Operating/Storage Temperature	-40°C To +85°C	
Lead Solder Temperature [2]	260°C For 3 Seconds	
Lead Solder Temperature [3]	260°C For 5 Seconds	

Notes:

1. 1/10 Duty Cycle, 0.1ms Pulse Width.
2. 2mm below package base.
3. 5mm below package base.

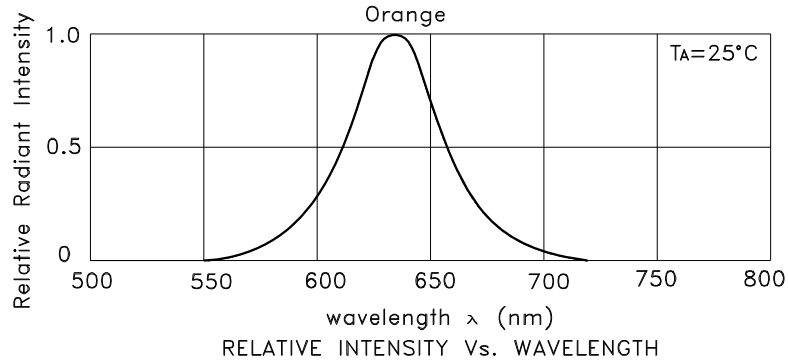

Orange

WP113EDT

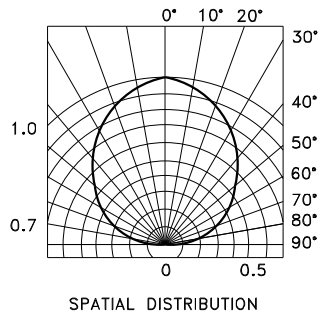
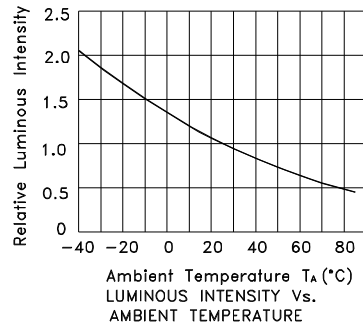
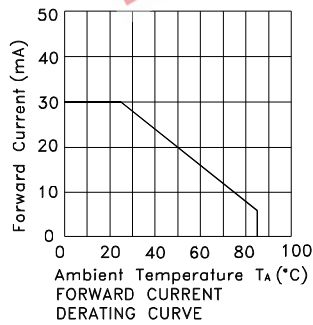
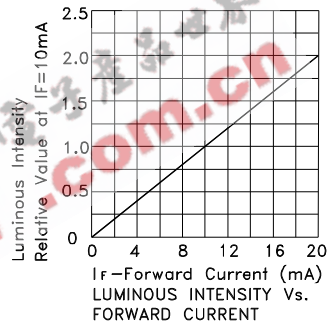
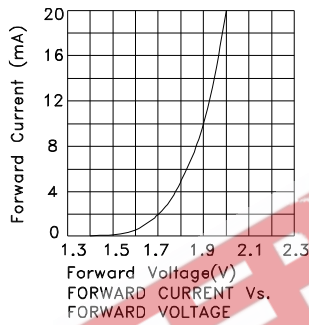

PACKING & LABEL SPECIFICATIONS

WP113EDT

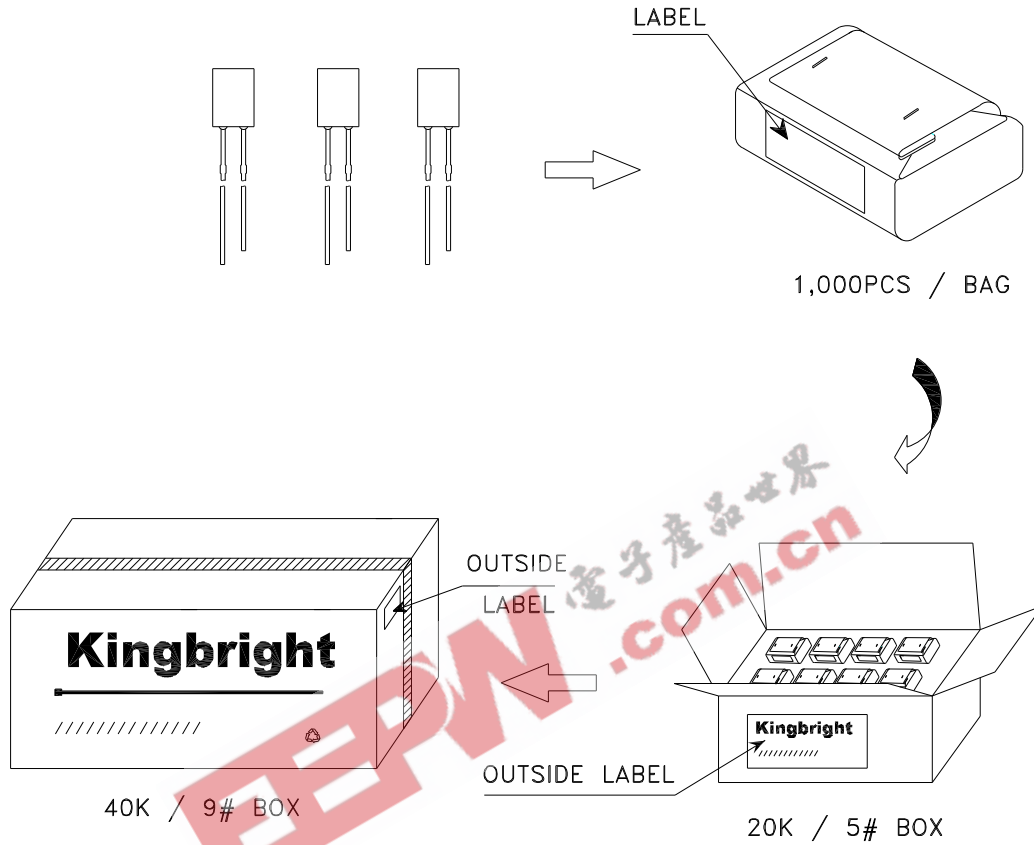

Kingbright				
Q.C.	<table border="1"> <tr> <td style="text-align: center;">QC</td> </tr> <tr> <td style="text-align: center;">XX XX XX</td> </tr> <tr> <td style="text-align: center;">PASSED</td> </tr> </table>	QC	XX XX XX	PASSED
QC				
XX XX XX				
PASSED				
TYPE NO : WP113xxx				
QUANTITY : 1,000 pcs				
S/N : XX	CODE: XX			
LOT NO :  xxxxxxxx				
RoHS Compliant				

LED MOUNTING METHOD

1. The lead pitch of the LED must match the pitch of the mounting holes on the PCB during component placement. Lead-forming may be required to insure the lead pitch matches the hole pitch. Refer to the figure below for proper lead forming procedures.

(Fig. 1)



Fig.1

“O” Correct mounting method “X” Incorrect mounting method

Note 1-2 : Do not route PCB trace in the contact area between the leadframe and the PCB to prevent short-circuits.

2. When soldering wire to the LED, use individual heat-shrink tubing to insulate the exposed leads to prevent accidental contact short-circuit.

(Fig. 2)

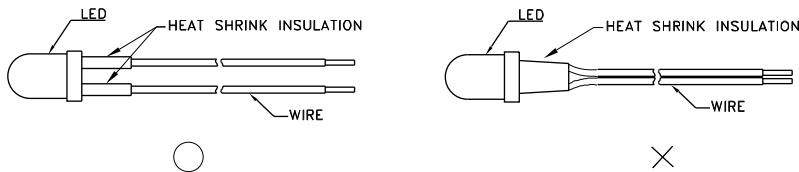

Fig. 2

3. Use stand-offs (Fig. 3) or spacers (Fig. 4) to securely position the LED above the PCB.

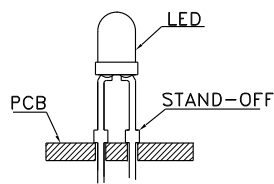

Fig. 3

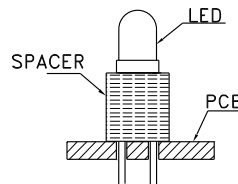

Fig. 4

LEAD FORMING PROCEDURES

1. Maintain a minimum of 2mm clearance between the base of the LED lens and the first lead bend. (Fig. 5 and 6)

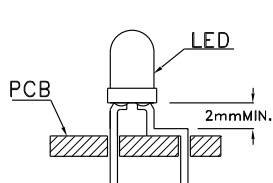

Fig. 5

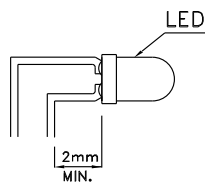

Fig. 6

2. Lead forming or bending must be performed before soldering, never during or after Soldering.
3. Do not stress the LED lens during lead-forming in order to fractures in the lens epoxy and damage the internal structures.
4. During lead forming, use tools or jigs to hold the leads securely so that the bending force will not be transmitted to the LED lens and its internal structures. Do not perform lead forming once the component has been mounted onto the PCB. (Fig. 7)
5. Do not bend the leads more than twice. (Fig. 8)

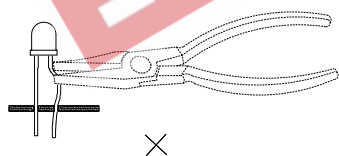

Fig. 7

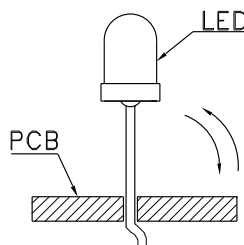

Fig. 8

6. After soldering or other high-temperature assembly, allow the LED to cool down to 50°C before applying outside force (Fig. 9). In general, avoid placing excess force on the LED to avoid damage. For any questions please consult with Kingbright representative for proper handling procedures.

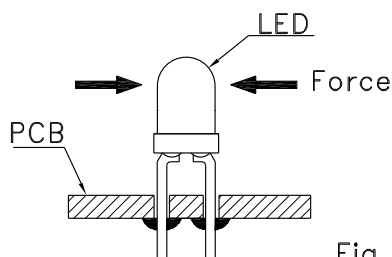

Fig. 9