

Energy Management Modular Power Quality Analyzer Type WM23-96



- Phases asymmetry control
- Optional RS 232 serial port
- Optional RS 422/485 serial port

Product Description

µP-based three-phase modular power quality analyzer with built-in programming key-pad. Particularly recommended for

a detailed analysis of the electrical variables and of the power quality. Housing for panel mounting and IP65 (front) protection degree.

- Accuracy ± 0.5 F.S. (current/voltage)
- Three-phase modular power analyzer
- Backlighted LCD 4x3 1/2 DGT Display
- Front size: 96x96 mm
- Measurements of phase and system variables: W, W_{dmd} , var, VA, VA_{dmd} , PF, V_{L-N} , V_{L-L} , A, An, Hz, THD-A, THD-V
- TRMS measurement of distorted waves (voltages/currents)
- Measurement of MAX values: W L1, W L2, W L3, W_{Σ} , W_{dmd} (AL1-AL2-AL3 max on request)
- Measurement of MIN values: PF L1, PF L2, PF L3, PF_{Σ}
- Harmonic analysis (FFT) up to the 16th harmonic (current and voltage)
- Instantaneous variables read-out: 4x3 1/2 digit
- Up to 2 optional relay or open collector outputs
- 1 optional analogue output
- MODBUS, JBUS Protocol
- Protection degree (front): IP 65
- Universal power supply: 18-60VAC/VDC, 90-260 VAC/VDC

Ordering Key

WM23-96AV53H XX XX XX XX X

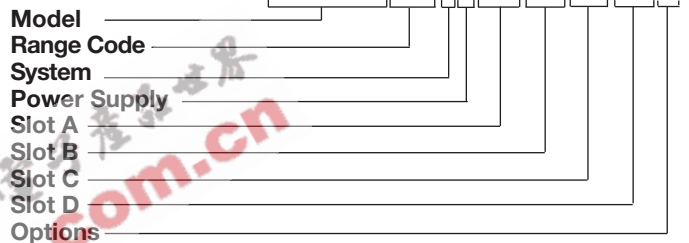

Type selection

Range code	Slot A (signal retransmission)	Slot B (communication)	Slot C (redundant output or digital inputs)
AV4: 208VLL/5(6)AAC -20% ≤ Un ≤ +20%	XX: None	XX: None	XX: None
AV5: 400VLL/5(6)AAC -20% ≤ Un ≤ +15%	A1: Single analogue output, 20mADC	S1: Serial port, RS485 multidrop, bidirectional	R1: Single relay output (AC1-8AAC, 250VAC)
AV6: 100VLL/5(6)AAC -20% ≤ Un ≤ +15%	A2: Single analogue output, ±5mADC	NOTE: max. digital output (alarms and/or pulses): 2, any exceeding output is redundant.	R2: Dual relay output (AC1-8AAC, 250VAC)
AV7: 660VLL/5(6)AAC -30% ≤ Un ≤ +15%	A3: Single analogue output, ±10mADC		O1: Single open collector output (30V/100mADC)
50-60 Hz for all input modules. Module not removable.	A4: Single analogue output, ±20mADC	NOTE: the second analogue output is intended as redundant type only.	O2: Dual open collector output (30V/100mADC)
System	B1: Dual analogue output, 20mADC		D1: 3 digital inputs
3: Three-phase, unbalanced load, with or without neutral	B2: Dual analogue output, ±5mADC	NOTE: with the A, B, C, D types power supply, only an open collector module or a single relay output module can be used. The instrument can be fully equipped only with L and H type power supply.	D2: 3 digital inputs + aux output
Power supply	B3: Dual analogue output, ±10mADC		Slot D (alarm output)
A: 24 VAC -15 +10% 50-60Hz	B4: Dual analogue output, ±20mADC	XX: None	R1: Single relay output, (AC1-8AAC, 250VAC)
B: 48 VAC -15 +10% 50-60Hz	V1: Single analogue output, 10VDC	R2: Dual relay output, (AC1-8AAC, 250VAC)	O1: Single open collector output (30V/100mADC)
C: 115VAC -15 +10% 50-60Hz	V2: Single analogue output, ±1VDC	O2: Dual open collector output (30V/100mADC)	Options
D: 230 VAC -15 +10% 50-60Hz	V3: Single analogue output, ±5VDC	X: None	S: RS232 serial port displaying and recording of AL1-AL2-AL3 max instead of WL1-WL2-WL3 max.
L: 18 to 60VAC/VDC	V4: Single analogue output, ±10VDC	A:	Y: Options: S+A above.
H: 90 to 260VAC/VDC	W1: Dual analogue output, 10VDC		
	W2: Dual analogue output, ±1VDC		
	W3: Dual analogue output, ±5VDC		
	W4: Dual analogue output, ±10VDC		

Input Specifications

Number of analogue inputs		Active power (@ 25°C ± 5°C, R.H. ≤ 60%)	±(1% Pn +2DGT)
Current	3	Reactive Power (@ 25°C ± 5°C, R.H. ≤ 60%)	±(2% Pn +2DGT)
Voltage	4	Apparent power (@ 25°C ± 5°C, R.H. ≤ 60%)	±(1% Pn +2DGT)
Digital Inputs	On request	Harmonic distortion (@ 25°C ± 5°C, R.H. ≤ 60%)	±3% F.S. (up to 16 th harmonic) (F.S.: 100%)
AQ1038	Number of inputs: 3 (voltage free)	Additional errors	
Use	Synchronization of the W-VA dmd measurements	Humidity	≤0.3% F.S. from 60% to 90% H.R.
	Input 1: lock of programming	Temperature drift	≤ 200ppm/°C
	Inputs 2 and 3: W-VA dmd measurements synchronization	Display	Back-lighted LCD 4x3 ¹ / ₂ digit 70 x 38mm
Reading voltage	24VDC/1mA	Display refresh time	700ms
AQ1042	Number of inputs: 3 + inputs power supply	Measurements	Current, voltage, power, power factor, frequency, harmonic distortion. TRMS measurement of a distorted wave.
Input frequency	Max 20Hz, dutycycle 50%	Coupling type	Direct
Output voltage	16V<+Aux<24VDC	Input impedance	
Output current	Max 15mA	208VLL 5(6)AAC (AV4):	>200 kΩ
Open contact resistance		400VLL 5(6)AAC (AV5):	>900 kΩ
Insulation	Min 100kΩ 4000VRMS	100VLL 5(6)AAC (AV6):	>200 kΩ
Accuracy (display, RS232, RS485)	In=5A; Pn= In* Un Un: F.S. range AV4-5-6-7	660VLL 5(6)AAC (AV7):	>900 kΩ
Current	±(0.5% In +2DGT)		
Phase-neutral voltage	±(0.5% Un +2DGT)		
Phase-phase voltage	±(1% Un +2DGT)		
Frequency	±0.1Hz		

Output Specifications

Analogue Outputs	(on request)	Insulation	By means of optocouplers, 4000 V _{RMS} output to measuring input
Number of outputs	Up to 1 (+1 redundant)		4000 V _{RMS} output to supply input
Accuracy	±0.2% f.s. (@ 25°C ± 5°C, R.H. ≤ 60%)	RS422/RS485	(on request)
Range	0 to 20 mADC, 0 to ±20 mADC 0 to ±10 mADC, 0 to ±5 mADC 0 to 10 VDC, 0 to ±10 VDC 0 to ±5 VDC 0 to ±1 VDC	Connections	Multidrop bidirectional (static and dynamic variables) 2 or 4 wires, max. distance 1200m, termination directly on the instrument
Scaling factor:	Programmable within the whole range of retransmission; it allows the retransmission management of all values from: 0 and 20 mADC,	Addresses	255, selectable by key-pad
Variables	See relevant list	Protocol	MODBUS/JBUS (RTU)
Response time	≤ 900 ms typical (filter excluded, FFT excluded)	Data (bidirectional)	System and phase variables: see table "display pages"
Ripple	≤ 1%	Dynamic (reading only)	All the configuration parameters, activation of the static output.
Total temperature drift (put)	acc. to IEC 60688-1, EN 60688-1	Static (writing only)	
Load:	≤ 500 ppm/°C (input+output)	Data format	1 start bit, 8 data bit, no parity, 1 stop bit
20 mADC	≤ 600 Ω	Baud-rate	9600 bauds
±20 mADC	≤ 550 Ω	Insulation	By means of optocouplers, 4000 V _{RMS} output to measuring input
±10 mADC	≤ 1100 Ω		4000 V _{RMS} output to supply input
± 5 mADC	≤ 2200 Ω	RS232	(on request)
10 VDC	≥ 10 kΩ		bidirectional (static and dynamic variables)
±10 VDC	≥ 10 kΩ	Connections	3 wires, max. distance 15m,
± 5 VDC	≥ 10 kΩ	Data format	1 start bit, 8 data bit
± 1 VDC	≥ 10 kΩ		

Output Specifications (cont.)

Baud-rate Protocol other data	no parity, 1 stop bit 9600 bauds MODBUS/JBUS (RTU) as per RS422/485	Output type	Relay, SPDT type AC 1-8A @ 250VAC DC 12-5A @ 24VDC AC 15-2.5A @ 250VAC DC 13-2.5A @ 24VDC
Digital outputs	(on request) To be used as alarms or remote control.	Min. response time	≤ 150 ms, filter excluded, FFT excluded, setpoint on-time delay: "0 s"
Alarm outputs Number of outputs Alarm type Variables to be controlled Set-point adjustment Hysteresis On-time delay Relay status	(on request) up to 2, independent Up alarm, down alarm see the "List of the variables that can be connected..." from 0 to 100% of the electrical scale from 0 to 100% of the electrical scale 0 to 255s Selectable, normally de-energized and normally energized	Insulation Note	By means of optocouplers, 4000 V _{RMS} output to measuring input, 4000 V _{RMS} output to supply input. The outputs can be either relay type or open collector type (V _{ON} 1.2VDC/Max. 100mA, V _{OFF} 30VDC Max.). Insulation like relay outputs.

Software Functions

Password 1st level 2nd level	Numeric code of max 4 digits; 2 protection levels of the programming data Password "0", no protection Password from 1 to 1000, all data are protected.	Page 5: PF L1(min), PF L2 (min), PF L3 (min) Page 6: W L1, W L2, W L3 Page 7: W L1 (max), W L2 (max), W L3 (max)
Transformer ratio	CT from 1 to 5000 VT from 1.0 to 1999, where CT x VT ≤ 10000	Page 7: "A" option: AL1 (max) AL2 (max) AL3 (max)
Power demand (dmd) Integration time	Programmable from 1 to 30 min	Page 8: var L1, var L2, var L3 Page 9: VA L1, VA L2, VA L3 Page 10: AL1 (alarm 1) Page 11: AL2 (alarm 2) Page 12: WΣ, PFΣ, varΣ, Hz Page 13: WΣ, PFΣ, VAΣ, Hz Page 14: WΣ (max), PFΣ (min) Page 15: W dmd, VA dmd, r.t. Page 16: W dmd (max), VA dmd (max)
Filter Filter operating range Filtering coefficient Filter action	From 0 to 100% of the input electrical scale 1 to 16 Measurements, alarms, serial port (fundamental variables: V, A, W and their derived ones).	Page 17: THD VL1, THD VL2, THD VL3 Page 17: THD AL1, THD AL2, THD AL3
Page Variables Three-phase system with neutral	Up to 4 by page Page 1: V L1, V L2, V L3, V LNΣ Page 2: V L12, V L13, V L31, VΣ Page 3: A L1, A L2, AL3, An Page 4: PF L1, PF L2, PF L3, PFΣ	

Supply Specifications

AC voltage	90 to 260 VDC/VAC 18 to 60VDC/VAC 24 VAC -15+10% 50-60Hz 48 VAC -15+10% 50-60Hz	Power consumption	115VAC -15+10% 50-60Hz 230 VAC -15+10% 50-60Hz ≤ 30VA/12W (90 to 260V) ≤ 20VA/12W (18 to 60V)
-------------------	--	--------------------------	--



General Specifications

Operating temperature	0 to +50°C (32 to 122°F) (R.H. < 90% non condensing)	Immunity	light industry environment EN 61000-6-2 (class A) industrial environment
Storage temperature	-10 to +60°C (14 to 140°F) (R.H. < 90% non condensing)	Other standards	Safety Product
Installation category	Cat. III (IEC 60664)	Approvals	IEC 61010-1, EN 61010-1 IEC 60688-1, EN 60688-1
Pollution degree	2	Connections 5(6)A	CE, UL, CSA
Key-pad lock	by means of a rotary switch placed behind the display or by means of a contact (in case of presence of the digital inputs module)	Housing	Dimensions Material
Insulation	4000 V _{RMS} between all inputs/outputs to ground		96x96x140 mm ABS, NORYL, PC (front) self-extinguishing: UL 94 V-0
Dielectric strength	4000 V _{RMS} for 1 minute	Protection degree	Front: IP65, NEMA4x, NEMA12 Connections: IP20
EMC		Weight	Approx. 400 g (packing incl.)
Emissions	EN 61000-6-3 (class A) residential, commercial and		

Function Description

Input/analogue output scaling capability

Working of the analogue output (Y) versus the input variable (X) - (input/output scaling capability)

Figure A

The sign of measured quantity and output quantity remains the same. The output quantity is proportional to the measured quantity.

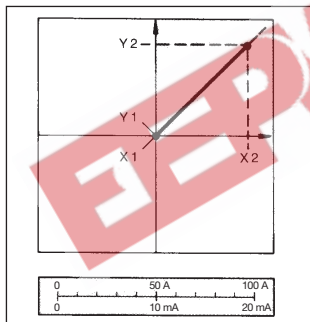

Figure D

The sign of measured quantity and output quantity remains the same. With the measured quantity being zero, the output quantity has the value $Y_1 = 0.2$ (live zero output).

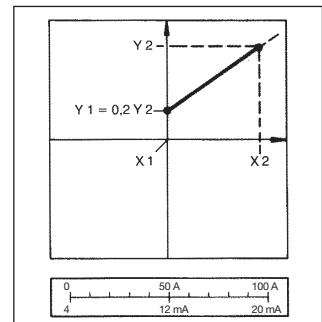

Figure B

The sign of measured quantity and output quantity changes simultaneously. The output quantity is proportional to the measured quantity.

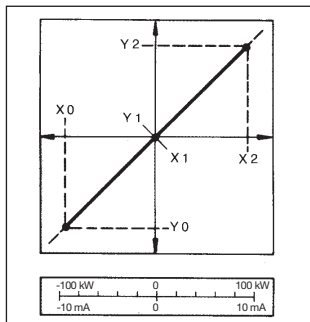

Figure E

The sign of the measured quantity changes but that of the output quantity remains the same. The output quantity steadily increases from the value X_1 to the value X_2 of the measured quantity.

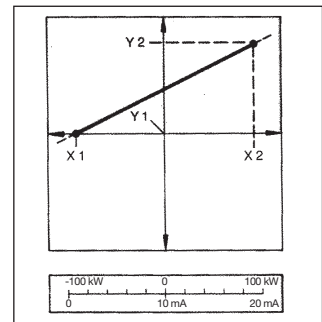

Figure C

The sign of measured quantity and output quantity remains the same. From X_0 to X_1 , the output variable is 0. The range $X_1...X_2$ is delineated on the entire output range.

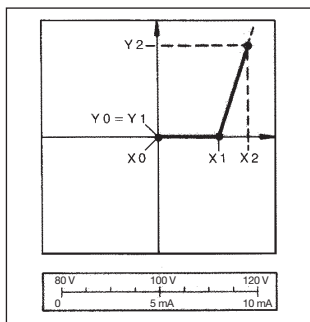
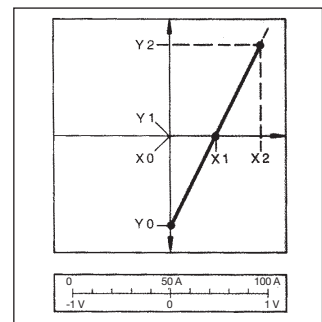

Figure F

The sign of the measured quantity remains the same, that of the output quantity changes as the measured quantity leaves range $X_0...X_1$ and passes to range $X_1...X_2$.



Mode of operation

Waveform of the signals that can be measured

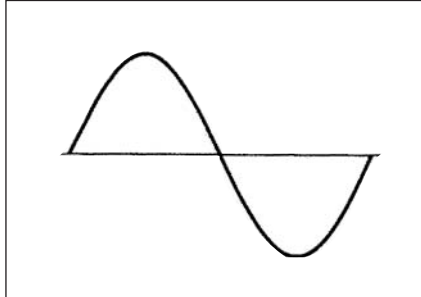

Figure G
Sinewave, undistorted
 Fundamental content 100%
 Harmonic content 0%
 $A_{rms} = 1.1107 | A |$

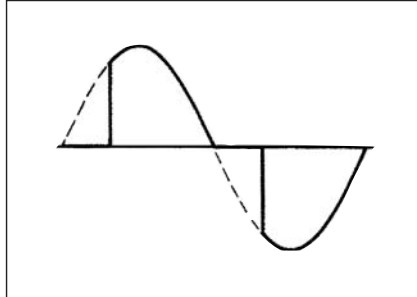

Figure H
Sinewave, indented
 Fundamental content 10...100%
 Harmonic content 0...90%
 Frequency spectrum: 3rd to 16th harmonic

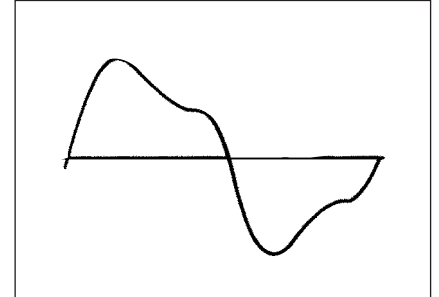

Figure I
Sinewave, distorted
 Fundamental content 70...90%
 Harmonic content 10...30%
 Frequency spectrum: 3rd to 16th harmonic

Harmonic Analysis

Analysis principle	FFT	Display pages	THD %
Harmonic measurement		Others	The harmonic distortion can be measured in both 3-wire or 4-wire systems.
Current	Up to 16th harmonic		
Voltage	Up to 16th harmonic		
Type of harmonics	THD (V L1) THD (V L2) THD (V L3) THD (A L1) THD (A L2) THD (A L3)		

Display pages

Variables that can be displayed in case of a three-phase system, 4-wire connection.

No	1st variable	2nd variable	3rd variable	4th variable	Notes
1	V L1	V L2	V L3	V LN Σ	Σ = system
2	V L1-2	V L2-3	V L3-1	V Σ	Σ = system
3	A L1	A L2	A L3	A n	A n= neutral current
4	PF L1	PF L2	PF L3	PF Σ	Σ = system
5	PF L1 (min)	PF L2 (min)	PF L3 (min)		
6	W L1	W L2	W L3		
7	W L1 (max)	W L2 (max)	W L3 (max)		With "A" option: AL1-AL2-AL3 max
8	var L1	var L2	var L3		
9	VA L1	VA L2	VA L3		
10	AL 1				variable connected to alarm 1
11	AL 2				variable connected to alarm 2
12	W Σ	PF Σ	var Σ	Hz	Σ = system
13	W Σ	PF Σ	VA Σ	Hz	Σ = system
14	W Σ (max)	PF Σ (min)			Σ = system
15	W dmd	VA dmd	r.t.		r.t.= symbol of communication Rx/Tx on the serial port
16	W dmd (max)	VA dmd (max)			
17	THD V L1	THD V L2	THD V L3		total harmonic distortion
18	THD A L1	THD A L2	THD A L3		total harmonic distortion

Used Calculation Formula

Phase Variables

Instantaneous effective voltage Instantaneous effective current

$$V_{IN} = \sqrt{\frac{1}{n} \cdot \sum_1^n (V_{IN})_i^2}$$

$$A_1 = \sqrt{\frac{1}{n} \cdot \sum_1^n (A_1)_i^2}$$

Instantaneous active power

Instantaneous apparent power

$$VA_1 = V_{IN} \cdot A_1$$

$$W_1 = \frac{1}{n} \cdot \sum_1^n (V_{IN})_i \cdot (A_1)_i$$

Instantaneous reactive power

Instantaneous power factor

$$VAR_1 = \sqrt{(VA_1)^2 - (W_1)^2}$$

$$\cos\phi_1 = \frac{W_1}{VA_1}$$

System variables

Three-phase active power Equivalent three-phase voltage

$$W_\Sigma = W_1 + W_2 + W_3$$

$$V_\Sigma = \frac{V_{12} + V_{23} + V_{31}}{3}$$

Three-phase apparent power

Three-phase reactive power

$$VA_\Sigma = \sqrt{W_\Sigma^2 + VAR_\Sigma^2}$$

$$VAR_\Sigma = (VAR_1 + VAR_2 + VAR_3)$$

Three-phase power factor

Neutral current

$$\cos\phi_\Sigma = \frac{W_\Sigma}{VA_\Sigma}$$

$$An = \overline{A}_{L1} + \overline{A}_{L2} + \overline{A}_{L3}$$

Total harmonic distortion

Where:

$$THD_i = \frac{\sqrt{\sum_{n=2}^n T_{n,i}^2}}{T_{1,i}}$$

i = considered phase (L1, L2 or L3)

T = considered variable (V or A)

n = harmonic order

List of the variables that can be connected to:

- Alarm outputs
- Analogue outputs

N°	Variable	3-phase + neutral	3-phase no neutral	Note
1	$V_{L-N\Sigma}$	x	x	Σ = system
2	$V_{L-L\Sigma}$	x	x	Σ = system
3	$W\Sigma$	x	x	Σ = system
4	$var\Sigma$	x	x	Σ = system
5	$VA\Sigma$	x	x	Σ = system
6	$PF\Sigma$	x	x	Σ = system
7	THD V (1)	x	x	if FFT is activated
8	THD A (1)	x	x	if FFT is activated
9	A n	x	x	
10	VA dmd	x	x	
11	W dmd	x	x	
12	ASY	x	x	asymmetry

(1) The highest value among the three phases

(2) The RS232 communication port works as alternative of the RS485 module.

The possible module combinations

Basic unit	Slot A	Slot B	Slot C	Slot D
Single analogue output	●			
Dual analogue output	●			
RS485 port		●		
Single relay output			●	
Single open collector output			●	
Dual relay output			●	●
Dual open collector output			●	●
3 digital inputs			●	
3 digital inputs + AUX			●	
Basic unit	Slot E			
RS232 port		●		

The available modules

Type	N. of channels	Ordering Code
WM23-96 400V L-L 5A (base)		AH2300
WM23-96 208V L-L 5A (base)		AH2301
WM23-96 100V L-L 5A (base)		AH2302
WM23-96 660V L-L 5A (base)		AH2303
WM23-96 400V L-L 5A (base)	"A" opt.	AH2300A
WM23-96 208V L-L 5A (base)	"A" opt.	AH2301A
WM23-96 100V L-L 5A (base)	"A" opt.	AH2302A
WM23-96 660V L-L 5A (base)	"A" opt.	AH2303A
24VAC power supply		AP1025
48VAC power supply		AP1024
115VAC power supply		AP1023
230VAC power supply		AP1022
18-60VAC/DC power supply		AP1021
90-260VAC/DC power supply		AP1020
20mADC analogue output	1	AO1050
10VDC analogue output	1	AO1051
±5mADC analogue output	1	AO1052
±10mADC analogue output	1	AO1053
±20mADC analogue output	1	AO1054
±1VDC analogue output	1	AO1055
±5VDC analogue output	1	AO1056
±10VDC analogue output	1	AO1057
20mADC analogue output	2	AO1026
10VDC analogue output	2	AO1027
±5mADC analogue output	2	AO1028
±10mADC analogue output	2	AO1029
±20mADC analogue output	2	AO1030
±1VDC analogue output	2	AO1031
±5VDC analogue output	2	AO1032
±10VDC analogue output	2	AO1033
Relay output	1	AO1058
Relay output	2	AO1035
Open collector output	1	AO1059
Open collector output	2	AO1036
Digital inputs	3	AQ1038
Digital inputs + AUX	3	AQ1042
RS485 serial port (2)	1	AR1034
RS232 serial port (2)	1	AR1039

Wiring Diagrams

Single phase

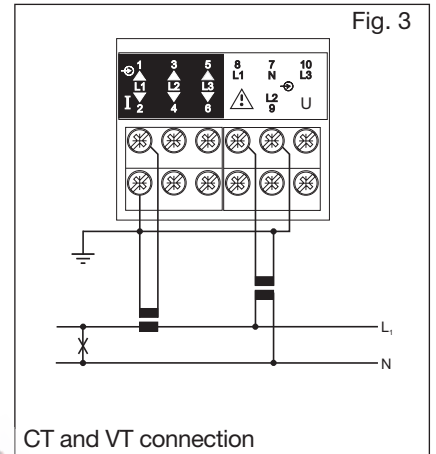
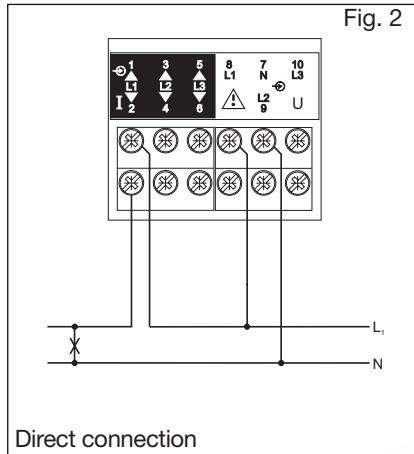
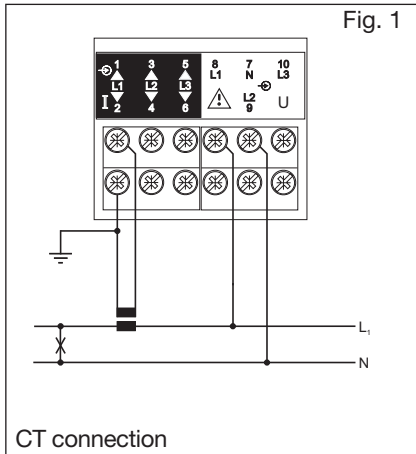

Three-phase - Unbalanced load

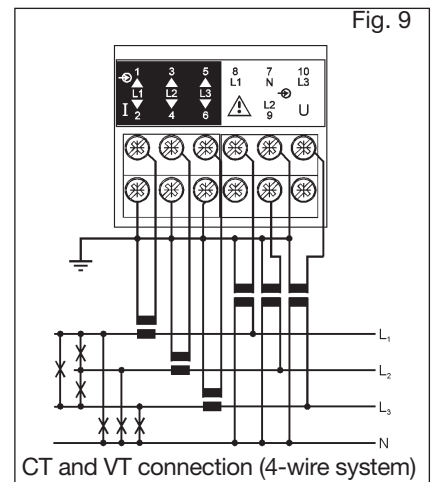
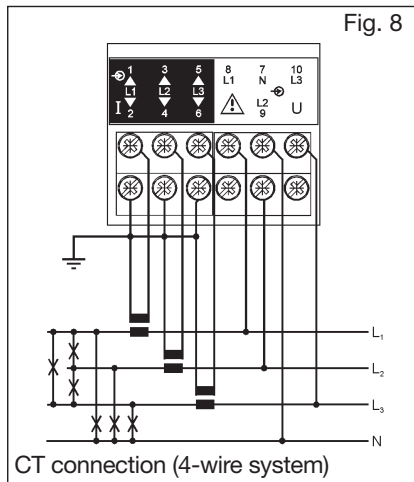
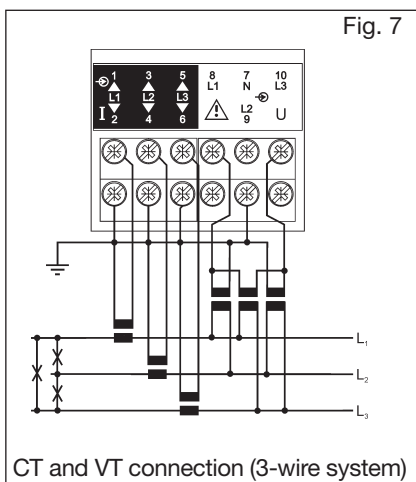
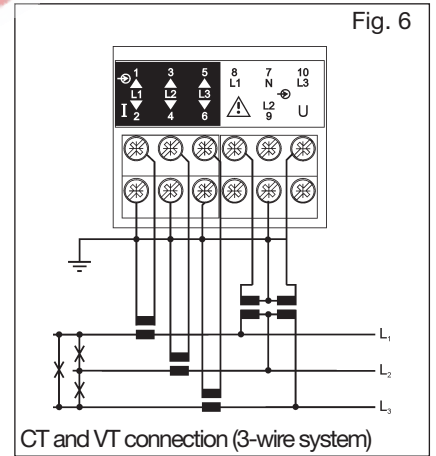
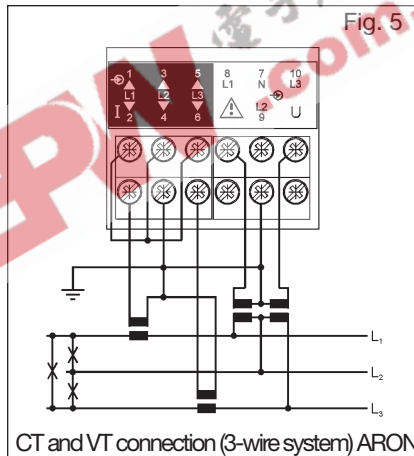
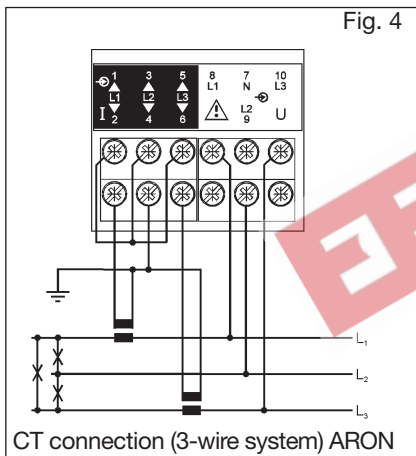



Wiring diagrams (optional modules)

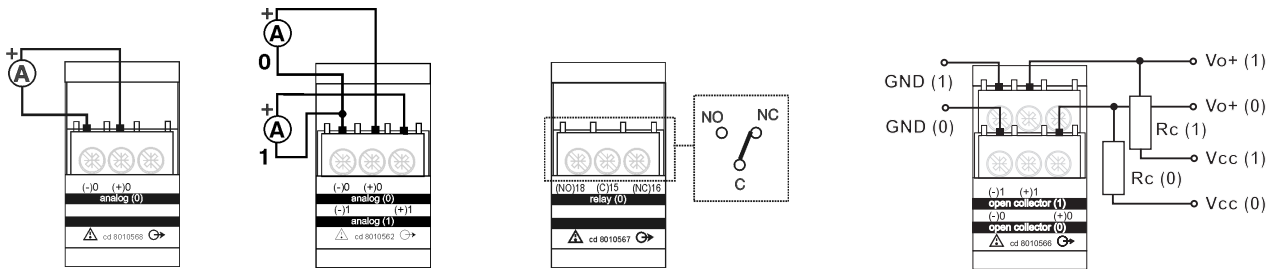

1 analogue output (mA)

2 analogue outputs (mA)

1 relay outputs

Open collector output connection. This wiring diagram is valid also for the open collector module with one output. The load resistances (RC) must be designed so that the close contact current is lower than 100mA; the VDC voltage must be lower than or equal to 30VDC.

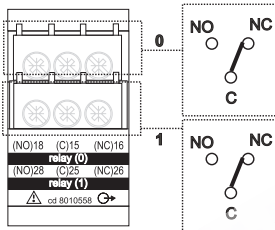
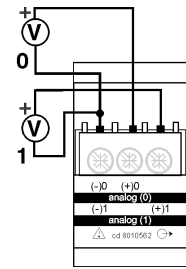
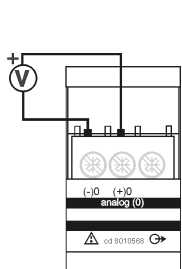

1 analogue output (V)

2 analogue outputs (V)

2 relay outputs

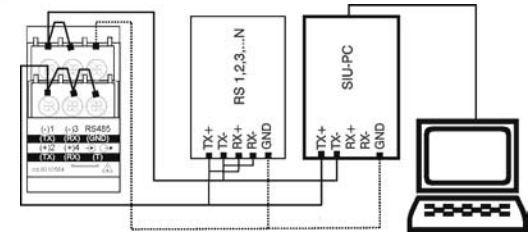
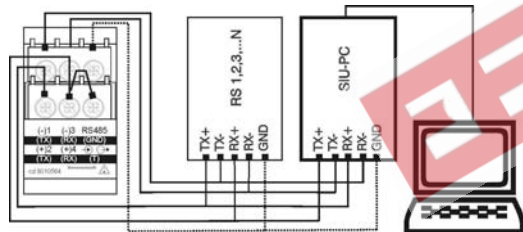

4-wire connection of RS485 serial port

2-wire connection of RS485 serial port

Wiring diagrams: digital input modules

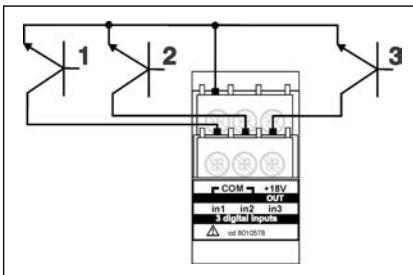

Connection by means of NPN transistors. Digital input module: AQ1042.

Connection by means of PNP transistors. Digital input module: AQ1042.

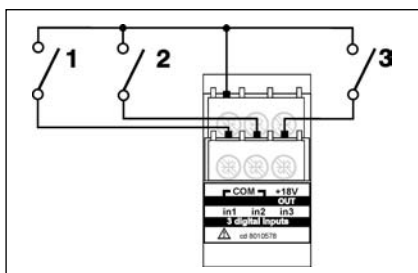
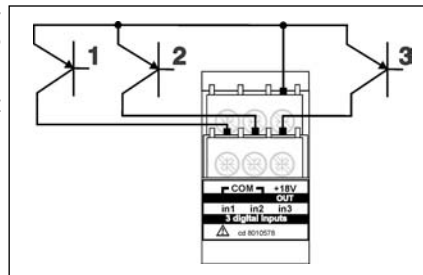

Connection by means of contacts. Digital input module: AQ1042.

Connection by means of contacts. Digital input module: AQ1038.

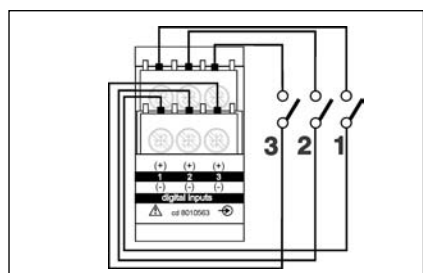

Front Panel Description

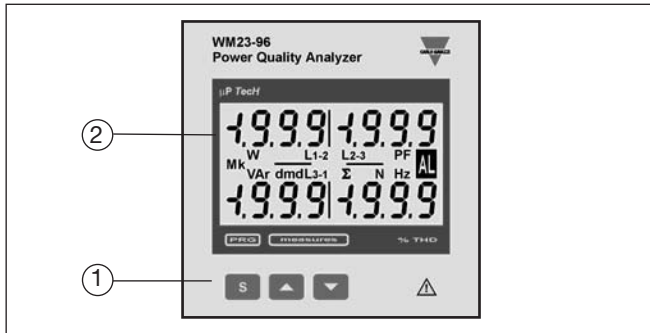

1. Key-pad

The programming of configuration parameters and the display are easily controlled by means of the 3 push buttons:

- "S" to enter into the programming phase and to confirm the password

▲ and ▼

- for value programming
- for function selections
- for page scrolling

2. Display

- Instantaneous measurements:
- 4x3 1/2 digit (maximum read-out 1999)

Alphanumeric indications by means of LCD display for:

- Displaying the configuration parameters
- Displaying all the measured variables.

3. Programming lock

It's possible to lock the programming key-pad by means of a rotary switch located behind the instrument into the power supply slot. Turn counterclockwise the switch to lock the programming key-pad.

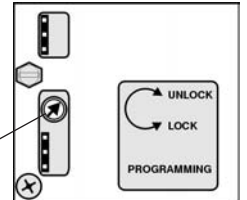

Dimensions

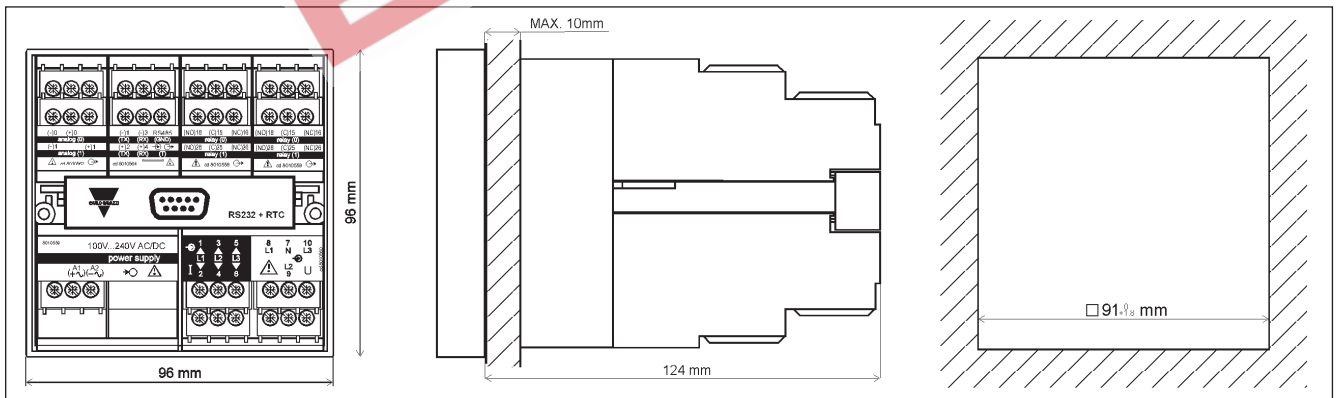

Terminal boards

Single analogue output modules

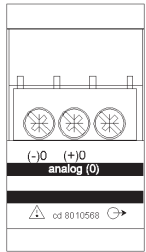

- AO1050** (20mADC)
- AO1051** (10VDC)
- AO1052** (± 5 mADC)
- AO1053** (± 10 mADC)
- AO1054** (± 20 mADC)
- AO1055** (± 1 VDC)
- AO1056** (± 5 VDC)
- AO1057** (± 10 VDC)

Dual analogue output modules

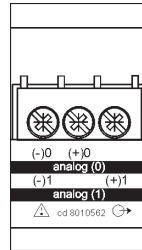

- AO1026** (20mADC)
- AO1027** (10VDC)
- AO1028** (± 5 mADC)
- AO1029** (± 10 mADC)
- AO1030** (± 20 mADC)
- AO1031** (± 1 VDC)
- AO1032** (± 5 VDC)
- AO1033** (± 10 VDC)

Digital output modules

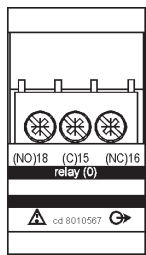

AO1058
Single relay output

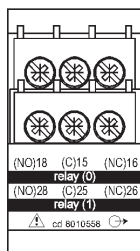

AO1035
Dual relay output

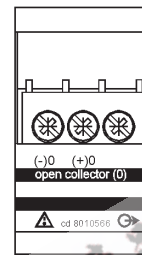

AO1059
Single open collector output

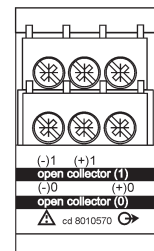

AO1036
Dual open collector output

Other input/output modules

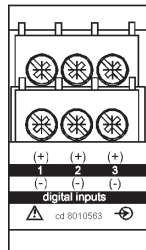

AQ1038
3 digital inputs

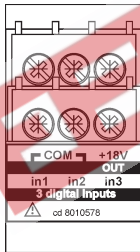

AQ1042
3 digital inputs + aux

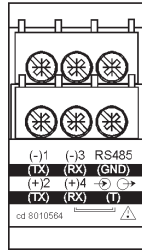

AR1034
RS422/485 communication port



AR1039
RS232 communication port

Power supply modules

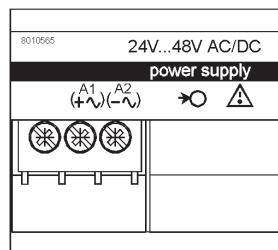

- AP1021** 18-60 VAC/DC power supply
- AP1020** 90-260 VAC/DC power supply
- AP1025** 24VAC power supply
- AP1024** 48VAC power supply
- AP1023** 115VCA power supply
- AP1022** 230VCA power supply