

## Mono CODEC for Portable Audio Applications

### DESCRIPTION

The WM8972L is a low power, high quality mono CODEC designed for portable digital audio applications.

The device integrates complete interfaces to mono microphones. External component requirements are drastically reduced as no separate microphone amplifiers are required. Advanced on-chip digital signal processing performs graphic equaliser and automatic level control for the microphone or line input.

The WM8972L can operate as a master or a slave, with various master clock frequencies including 12 or 24MHz for USB devices, or standard 256fs rates like 12.288MHz and 24.576MHz. Different audio sample rates such as 96kHz, 48kHz, 44.1kHz are generated directly from the master clock without the need for an external PLL.

The WM8972L operates at supply voltages down to 1.8V, although the digital core can operate at voltages down to 1.42V to save power, and the maximum for all supplies is 3.6 Volts. Different sections of the chip can also be powered down under software control.

The WM8972L is supplied in a very small and thin 5x5mm QFN package, ideal for use in hand-held and portable systems.

### FEATURES

- DAC SNR 98dB ('A' weighted), THD -84dB at 48kHz, 3.3V
- ADC SNR 95dB ('A' weighted), THD -82dB at 48kHz, 3.3V
- Complete Mono Microphone Interface
  - Programmable ALC / Noise Gate
- On-chip 400mW BTL Speaker Driver (mono)
- Digital Graphic Equaliser
- Low Power
  - 7mW mono playback (1.8V / 1.5V supplies)
  - 14mW record & playback (1.8V / 1.5V supplies)
- Low Supply Voltages
  - Analogue 1.8V to 3.6V
  - Digital core: 1.42V to 3.6V
  - Digital I/O: 1.8V to 3.6V
- 256fs / 384fs or USB master clock rates: 12MHz, 24MHz
- Audio sample rates: 8, 11.025, 16, 22.05, 24, 32, 44.1, 48, 88.2, 96kHz generated internally from master clock
- 5x5x0.9mm QFN package

### APPLICATIONS

- Digital Still Cameras
- Toys

### BLOCK DIAGRAM

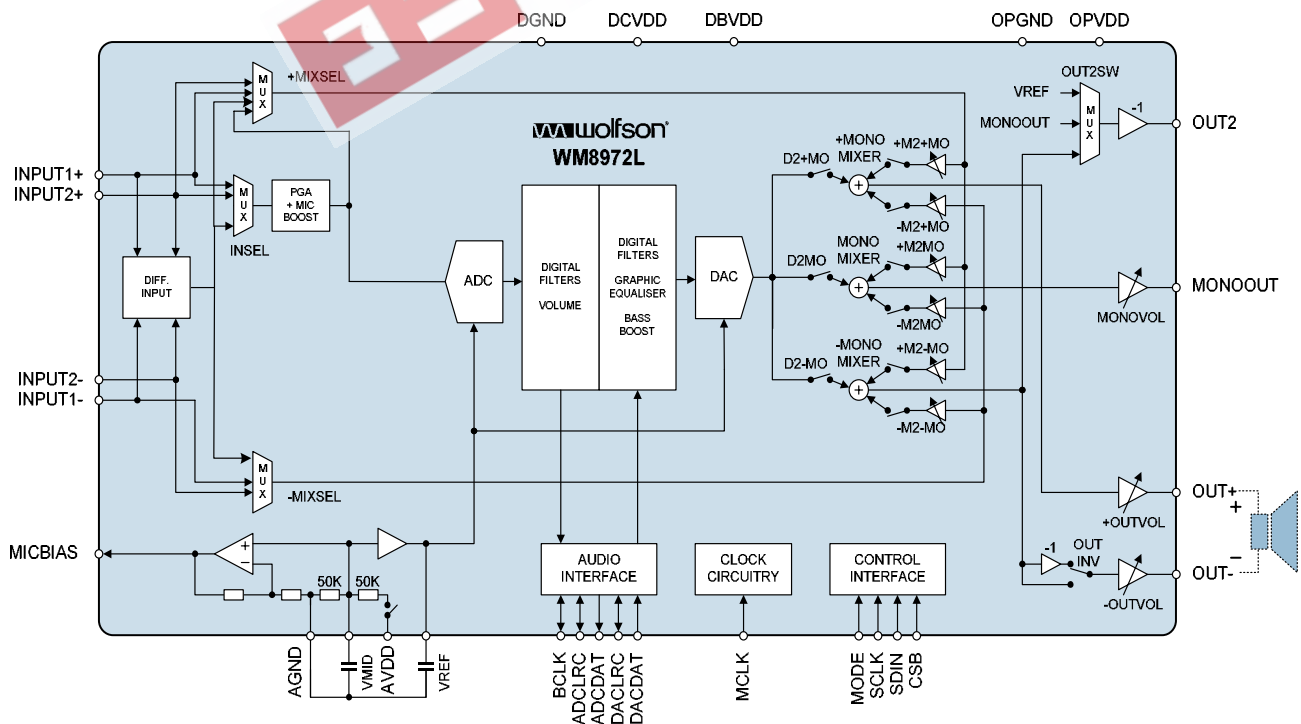

## TABLE OF CONTENTS

<b>DESCRIPTION</b> .....	<b>1</b>
<b>FEATURES</b> .....	<b>1</b>
<b>APPLICATIONS</b> .....	<b>1</b>
<b>BLOCK DIAGRAM</b> .....	<b>1</b>
<b>TABLE OF CONTENTS</b> .....	<b>2</b>
<b>PIN CONFIGURATION</b> .....	<b>3</b>
<b>ORDERING INFORMATION</b> .....	<b>3</b>
<b>PIN DESCRIPTION</b> .....	<b>4</b>
<b>ABSOLUTE MAXIMUM RATINGS</b> .....	<b>5</b>
<b>RECOMMENDED OPERATION CONDITIONS</b> .....	<b>5</b>
<b>ELECTRICAL CHARACTERISTICS</b> .....	<b>6</b>
OUTPUT PGA'S LINEARITY .....	7
<b>POWER CONSUMPTION</b> .....	<b>8</b>
<b>SIGNAL TIMING REQUIREMENTS</b> .....	<b>9</b>
SYSTEM CLOCK TIMING.....	9
AUDIO INTERFACE TIMING – MASTER MODE.....	9
AUDIO INTERFACE TIMING – SLAVE MODE .....	10
<b>DEVICE DESCRIPTION</b> .....	<b>13</b>
INTRODUCTION.....	13
INPUT SIGNAL PATH.....	13
AUTOMATIC LEVEL CONTROL (ALC) .....	18
OUTPUT SIGNAL PATH.....	21
ANALOGUE OUTPUTS .....	26
ENABLING THE OUTPUTS.....	27
THERMAL SHUTDOWN.....	27
DIGITAL AUDIO INTERFACE.....	28
AUDIO INTERFACE CONTROL .....	31
CLOCKING AND SAMPLE RATES .....	32
CONTROL INTERFACE .....	34
POWER SUPPLIES .....	35
POWER MANAGEMENT .....	36
REGISTER MAP .....	38
<b>DIGITAL FILTER CHARACTERISTICS</b> .....	<b>39</b>
TERMINOLOGY.....	39
DAC FILTER RESPONSES .....	40
ADC FILTER RESPONSES .....	41
DE-EMPHASIS FILTER RESPONSES .....	42
HIGHPASS FILTER .....	43
<b>APPLICATIONS INFORMATION</b> .....	<b>44</b>
RECOMMENDED EXTERNAL COMPONENTS.....	44
LINE INPUT CONFIGURATION.....	45
MICROPHONE INPUT CONFIGURATION .....	45
MINIMISING POP NOISE AT THE ANALOGUE OUTPUTS .....	46
POWER MANAGEMENT EXAMPLES .....	46
<b>IMPORTANT NOTICE</b> .....	<b>48</b>
ADDRESS:.....	48

### PIN CONFIGURATION

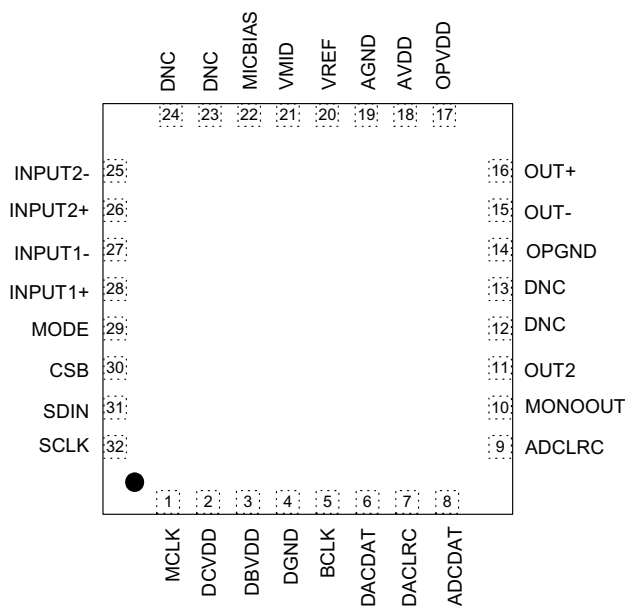

### ORDERING INFORMATION

ORDER CODE	TEMPERATURE RANGE	PACKAGE	MOISTURE SENSITIVITY LEVEL	PEAK SOLDERING TEMPERATURE
WM8972LEFL	-25°C to +85°C	32-pin QFN (5x5x0.9mm)	MSL1	260°C
WM8972LEFL/R	-25°C to +85°C	32-pin QFN (5x5x0.9mm) (tape and reel)	MSL1	260°C
WM8972LGEFL	-25°C to +85°C	32-pin QFN (5x5x0.9mm) (lead free)	MSL1	260°C
WM8972LGEFL/R	-25°C to +85°C	32-pin QFN (5x5x0.9mm) (lead free, tape and reel)	MSL1	260°C

**Note:**

Reel quantity = 3,500

**PIN DESCRIPTION**

PIN NO	NAME	TYPE	DESCRIPTION
1	MCLK	Digital Input	Master Clock
2	DCVDD	Supply	Digital Core Supply
3	DBVDD	Supply	Digital Buffer (I/O) Supply
4	DGND	Supply	Digital Ground (return path for both DCVDD and DBVDD)
5	BCLK	Digital Input / Output	Audio Interface Bit Clock
6	DACDAT	Digital Input	DAC Digital Audio Data
7	DACLRC	Digital Input / Output	Audio Interface Left / Right Clock/Clock Out
8	ADCDAT	Digital Output	ADC Digital Audio Data
9	ADCLRC	Digital Input / Output	Audio Interface Left / Right Clock
10	MONOOUT	Analogue Output	Mono Output
11	OUT2	Analogue Output	Analogue Output 2
12	DNC	Do not connect	Leave this pin floating
13	DNC	Do not connect	Leave this pin floating
14	OPGND	Supply	Supply for Analogue Output Drivers
15	OUT-	Analogue Output	- Output (Line or Speaker)
16	OUT+	Analogue Output	+ Output (Line or Speaker)
17	OPVDD	Supply	Supply for Analogue Output Drivers (OUT-/+ , MONOOUT)
18	AVDD	Supply	Analogue Supply
19	AGND	Supply	Analogue Ground (return path for both AVDD and MVDD)
20	VREF	Analogue Output	Reference Voltage Decoupling Capacitor
21	VMID	Analogue Output	Midrail Voltage Decoupling Capacitor
22	MICBIAS	Analogue Output	Microphone Bias
23	DNC	Do not connect	Leave this pin floating
24	DNC	Do not connect	Leave this pin floating
25	INPUT2-	Analogue Input	- Channel Input 2
26	INPUT2+	Analogue Input	+ Channel Input 2
27	INPUT1-	Analogue Input	- Channel Input 1
28	INPUT1+	Analogue Input	+ Channel Input 1
29	MODE	Digital Input	Control Interface Selection
30	CSB	Digital Input	Chip Select / Device Address Selection
31	SDIN	Digital Input/Output	Control Interface Data Input / 2-wire Acknowledge output
32	SCLK	Digital Input	Control Interface Clock Input

## ABSOLUTE MAXIMUM RATINGS

Absolute Maximum Ratings are stress ratings only. Permanent damage to the device may be caused by continuously operating at or beyond these limits. Device functional operating limits and guaranteed performance specifications are given under Electrical Characteristics at the test conditions specified.



ESD Sensitive Device. This device is manufactured on a CMOS process. It is therefore generically susceptible to damage from excessive static voltages. Proper ESD precautions must be taken during handling and storage of this device.

Wolfson tests its package types according to IPC/JEDEC J-STD-020B for Moisture Sensitivity to determine acceptable storage conditions prior to surface mount assembly. These levels are:

MSL1 = unlimited floor life at <30°C / 85% Relative Humidity. Not normally stored in moisture barrier bag.

MSL2 = out of bag storage for 1 year at <30°C / 60% Relative Humidity. Supplied in moisture barrier bag.

MSL3 = out of bag storage for 168 hours at <30°C / 60% Relative Humidity. Supplied in moisture barrier bag.

The Moisture Sensitivity Level for each package type is specified in Ordering Information.

CONDITION	MIN	MAX
Supply voltages	-0.3V	+3.63V
Voltage range digital inputs	DGND -0.3V	DBVDD +0.3V
Voltage range analogue inputs	AGND -0.3V	AVDD +0.3V
Operating temperature range, T <sub>A</sub>	-25°C	+85°C
Storage temperature after soldering	-65°C	+150°C

### Notes

1. Analogue and digital grounds must always be within 0.3V of each other.
2. All digital and analogue supplies are completely independent from each other.
3. DCVDD must be less than or equal to AVDD & DBVDD.

## RECOMMENDED OPERATION CONDITIONS

PARAMETER	SYMBOL	MIN	TYP	MAX	UNIT
Digital supply range (Core)	DCVDD	1.42	2.0	3.6	V
Digital supply range (Buffer)	DBVDD	1.8	2.0	3.6	V
Analogue supplies range	AVDD, OPVDD	1.8	2.0	3.6	V
Ground	DGND, AGND, OPGND		0		V

## ELECTRICAL CHARACTERISTICS

## Test Conditions

DCVDD = 1.5V, DBVDD = 3.3V, AVDD = OPVDD = 3.3V,  $T_A$  = +25°C, 1kHz signal,  $f_s$  = 48kHz, PGA gain = 0dB, 24-bit audio data unless otherwise stated.

PARAMETER	SYMBOL	TEST CONDITIONS	MIN	TYP	MAX	UNIT
<b>Analogue Inputs (LINPUT1, RINPUT1, LINPUT2, RINPUT2, LINPUT3, RINPUT3) to ADC out</b>						
Full Scale Input Signal Level (for ADC 0dB Input at 0dB Gain)	$V_{INFS}$	AVDD = 3.3V		1.0		V rms
		AVDD = 1.8V		0.545		
Input Resistance		+/-INPUT1 to ADC, PGA gain = 0dB		22		k $\Omega$
		+/-INPUT1 to ADC, PGA gain = +30dB		1.5		
		DC Measurement		16		
		+/-INPUT1 unused		17		
Input Capacitance				10		pF
Signal to Noise Ratio (A-weighted)	SNR	AVDD = 3.3V	80	95		dB
		AVDD = 1.8V		90		
Dynamic Range		-60dBFS	90	95		dB
Total Harmonic Distortion	THD	-1dBFS input, AVDD = 3.3V		-82 0.008	-77 0.014	dB %
		-1dBFS input, AVDD = 1.8V		-74 0.02		
<b>Analogue Outputs (OUT+/-, MONOOUT)</b>						
0dB Full scale output voltage				AVDD/3.3		Vrms
Mute attenuation		1kHz, full scale signal		90		dB
		MONOOUT pin		81		
<b>DAC to Line-Out (OUT+/- with 10k<math>\Omega</math> / 50pF load)</b>						
Signal to Noise Ratio (A-weighted)	SNR	AVDD=3.3V	90	98		dB
		AVDD=1.8V		93		
Total Harmonic Distortion	THD	AVDD=3.3V		-84		dB
		AVDD=1.8V		-80		
<b>Speaker Output (OUT +/- with 8<math>\Omega</math> bridge tied load, OUTINV=1)</b>						
Output Power	$P_O$	Output power is very closely correlated with THD; see below.				
Total Harmonic Distortion	THD	$P_o=180mW$ , $R_L=8\Omega$ , OPVDD=3.3V		-60 0.1		dB %
		$P_o=400mW$ , $R_L=8\Omega$ , OPVDD=3.3V		-36 1.6		
Signal to Noise Ratio (A-weighted)	SNR	OPVDD=3.3V, $R_L=8\Omega$		95		dB
<b>Analogue Reference Levels</b>						
Midrail Reference Voltage	VMID		-3%	AVDD/2	+3%	V
Buffered Reference Voltage	VREF		-3%	AVDD/2	+3%	V
<b>Microphone Bias</b>						
Bias Voltage	$V_{MICBIAS}$	3mA load current	-5%	0.9xAVDD	+ 5%	V
Bias Current Source	$I_{MICBIAS}$				3	mA
Output Noise Voltage	$V_n$	1K to 20kHz		15		nV/ $\sqrt{Hz}$
<b>Digital Input / Output</b>						
Input HIGH Level	$V_{IH}$		0.7xDBVDD			V
Input LOW Level	$V_{IL}$				0.3xDBVDD	V
Output HIGH Level	$V_{OH}$	$I_{OL}=1mA$	0.9xDBVDD			V
Output LOW Level	$V_{OL}$	$I_{OH}=1mA$			0.1xDBVDD	V

### OUTPUT PGA'S LINEARITY

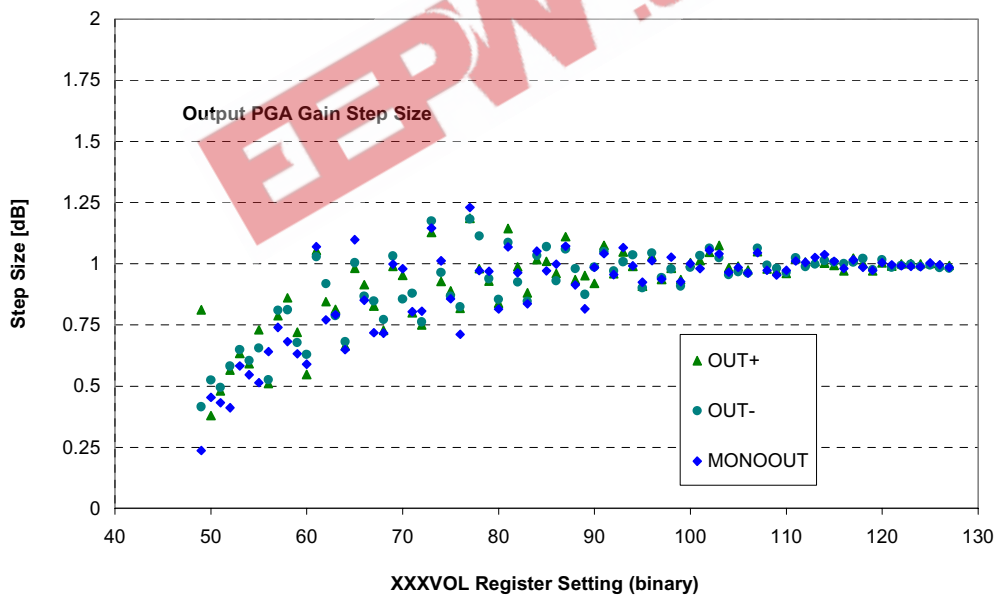
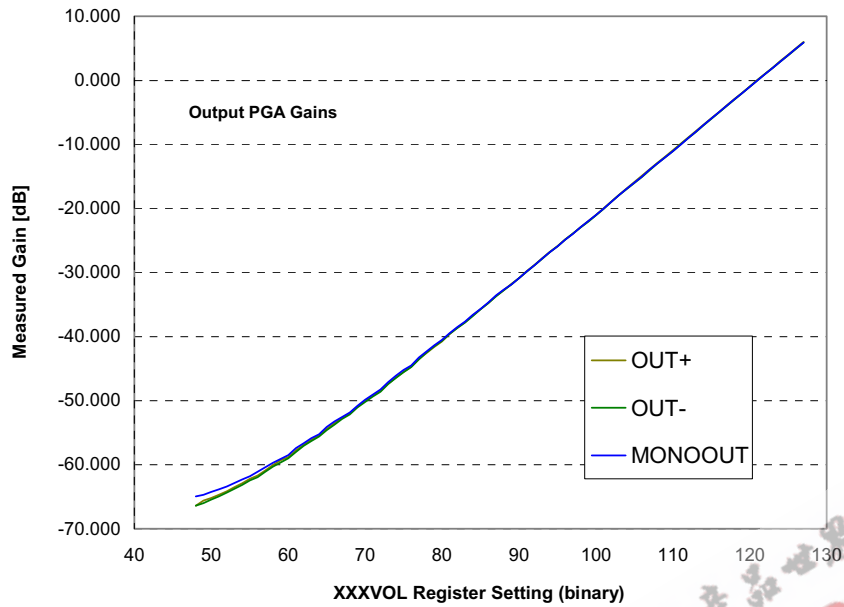

**POWER CONSUMPTION**

The power consumption of the WM8972L depends on the following factors.

- Supply voltages: Reducing the supply voltages also reduces supply currents, and therefore results in significant power savings, especially in the digital sections of the WM8972L.
- Operating mode: Significant power savings can be achieved by always disabling parts of the WM8972L that are not used (e.g. mic pre-amps, unused outputs, DAC, ADC, etc.)

Control Register	R25 (19h)				R26 (1Ah)				R24		R23	Other settings	AVDD		DCVDD		DBVDD		HPVDD		Tot. Power mW		
	VMIDSEL	VREF	AIN	ADC	MICB	DAC	OUT+	OUT-	MONO	OUT2	ADCSR		DACOSR	VSEL	V	I (mA)	V	I (mA)	V	I (mA)		V	I (mA)
OFF	00	0	0	0	0	0	0	0	0	0	0	0	11	Clocks stopped	3.3	0.0016	3.3	0.0190	3.3	0.0080	3.3	0.0002	0.0950
													00		2.5	0.0008	2.5	0.0170	2.5	0.0050	2.5	0.0000	0.0570
													01		1.8	0.0005	1.5	0.0120	1.5	0.0029	1.8	0.0000	0.0233
Standby (500 KOhm VMID string)	10	1	0	0	0	0	0	0	0	0	0	0	11	Interface Stopped	3.3	0.3900	3.3	0.0390	3.3	0.0080	3.3	0.0000	1.4421
													01		2.5	0.2880	2.5	0.0170	2.5	0.0050	2.5	0.0000	0.7750
													00		1.8	0.1970	1.5	0.0120	1.5	0.0030	1.8	0.0000	0.3771
Playback to 8 Ohm BTL Speaker	01	1	0	0	0	1	1	1	0	0	0	0	11	R24, OUTINV=1	3.3	TBD	3.3	TBD	3.3	TBD	3.3	TBD	TBD
													01		2.5	TBD	2.5	TBD	2.5	TBD	2.5	TBD	TBD
													00		1.8	TBD	1.5	TBD	1.5	TBD	1.8	TBD	TBD
Speaker Amp (line-in to 8 Ohm speaker)	01	1	0	0	0	0	1	1	0	0	0	0	11	Clocks Stopped R24, OUTINV=1	3.3	1.9780	3.3	0.0200	3.3	0.0080	3.3	0.3310	7.7121
													01		2.5	1.4300	2.5	0.0190	2.5	0.0050	2.5	0.2430	4.2425
													00		1.8	0.9860	1.5	0.0130	1.5	0.0030	1.8	0.1760	2.1156
Phone Call (mono line-in to headphone, mic to MONOOUT)	01	1	0	0	1	0	1	1	1	0	0	0	11	Clocks Stopped	3.3	2.5230	3.3	0.0370	3.3	0.0080	3.3	0.4420	9.9330
													01		2.5	1.8520	2.5	0.0190	2.5	0.0050	2.5	0.3200	5.4900
													00		1.8	1.2900	1.5	0.0130	1.5	0.0030	1.8	0.2240	2.7492
Record from Line-in	01	1	1	1	0	0	0	0	0	0	0	0	11		3.3	TBD	3.3	TBD	3.3	TBD	3.3	TBD	TBD
													01		2.5	TBD	2.5	TBD	2.5	TBD	2.5	TBD	TBD
													00		1.8	TBD	1.5	TBD	1.5	TBD	1.8	TBD	TBD
Record from Line-in (64x oversampling mode)	01	1	1	1	0	0	0	0	0	0	1	0	11		3.3	TBD	3.3	TBD	3.3	TBD	3.3	TBD	TBD
													01		2.5	TBD	2.5	TBD	2.5	TBD	2.5	TBD	TBD
													00		1.8	TBD	1.5	TBD	1.5	TBD	1.8	TBD	TBD
Record from mono microphone	01	1	1	1	1	0	0	0	0	0	0	0	11	R32, MICBOOST=11; R23, DATSEL=01	3.3	4.9330	3.3	6.5400	3.3	0.3390	3.3	0.0000	38.9796
													01		2.5	4.2970	2.5	4.2500	2.5	0.2400	2.5	0.0000	21.9675
													00		1.8	3.7210	1.5	2.2200	1.5	0.1370	1.8	0.0000	10.2333
Record from mono microphone (differential)	01	1	1	1	1	0	0	0	0	0	0	0	11	R32, MICBOOST=11; R23, DATSEL=01; R32, INSEL=11	3.3	5.2900	3.3	6.5000	3.3	0.3220	3.3	0.0000	39.9696
													01		2.5	4.5600	2.5	4.2700	2.5	0.2400	2.5	0.0000	22.6750
													00		1.8	3.9000	1.5	2.2200	1.5	0.1380	1.8	0.0000	10.5570
Record & Playback	01	1	1	1	1	1	1	1	0	0	0	0	11		3.3	TBD	3.3	TBD	3.3	TBD	3.3	TBD	TBD
													01		2.5	TBD	2.5	TBD	2.5	TBD	2.5	TBD	TBD
													00		1.8	TBD	1.5	TBD	1.5	TBD	1.8	TBD	TBD
Record & Playback (64x oversampling mode)	01	1	1	1	1	1	1	1	0	0	1	1	11		3.3	TBD	3.3	TBD	3.3	TBD	3.3	TBD	TBD
													01		2.5	TBD	2.5	TBD	2.5	TBD	2.5	TBD	TBD
													00		1.8	TBD	1.5	TBD	1.5	TBD	1.8	TBD	TBD

**Table 1 Supply Current Consumption**

**Notes:**

1. All figures are at T<sub>A</sub> = +25°C, Slave Mode, fs = 48kHz, MCLK = 12.288 MHz (256fs), with zero signal (quiescent)
2. The power dissipated in the headphone or speaker is not included in the above table.



## SIGNAL TIMING REQUIREMENTS

### SYSTEM CLOCK TIMING

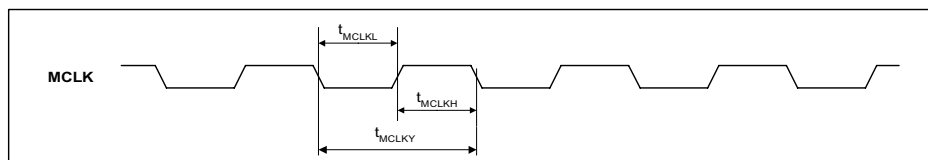

Figure 1 System Clock Timing Requirements

**Test Conditions**

CLKDIV2=0, DCVDD = 1.42V, DBVDD = 3.3V, DGND = 0V, T<sub>A</sub> = +25°C, Slave Mode fs = 48kHz, MCLK = 384fs, 24-bit data, unless otherwise stated.

PARAMETER	SYMBOL	MIN	TYP	MAX	UNIT
<b>System Clock Timing Information</b>					
MCLK System clock pulse width high	T <sub>MCLKL</sub>	21			ns
MCLK System clock pulse width low	T <sub>MCLKH</sub>	21			ns
MCLK System clock cycle time	T <sub>MCLKY</sub>	54			ns
MCLK duty cycle	T <sub>MCLKDS</sub>	60:40		40:60	

**Test Conditions**

CLKDIV2=1, DCVDD = 1.42V, DBVDD = 3.3V, DGND = 0V, T<sub>A</sub> = +25°C, Slave Mode fs = 48kHz, MCLK = 384fs, 24-bit data, unless otherwise stated.

PARAMETER	SYMBOL	MIN	TYP	MAX	UNIT
<b>System Clock Timing Information</b>					
MCLK System clock pulse width high	T <sub>MCLKL</sub>	10			ns
MCLK System clock pulse width low	T <sub>MCLKH</sub>	10			ns
MCLK System clock cycle time	T <sub>MCLKY</sub>	27			ns

### AUDIO INTERFACE TIMING – MASTER MODE

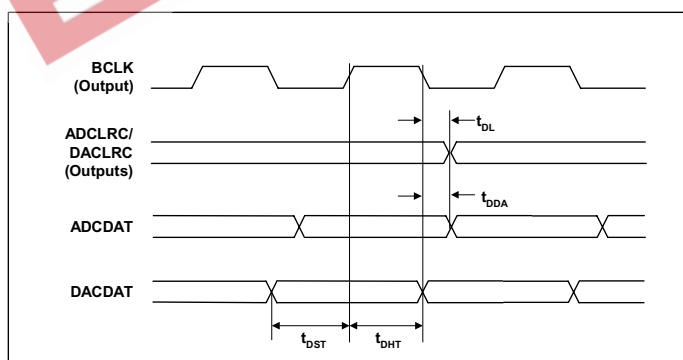

Figure 2 Digital Audio Data Timing – Master Mode (see Control Interface)

**Test Conditions**

DCVDD = 1.42V, DBVDD = 3.3V, DGND = 0V, T<sub>A</sub> = +25°C, Slave Mode, fs = 48kHz, MCLK = 256fs, 24-bit data, unless otherwise stated.

PARAMETER	SYMBOL	MIN	TYP	MAX	UNIT
<b>Bit Clock Timing Information</b>					
BCLK rise time (10pF load)	t <sub>BCLKR</sub>			3	ns
BCLK fall time (10pF load)	t <sub>BCLKF</sub>			3	ns
BCLK duty cycle (normal mode, BCLK = MCLK/n)	t <sub>BCLKDS</sub>		50:50		
BCLK duty cycle (USB mode, BCLK = MCLK)	t <sub>BCLKDS</sub>		T <sub>MCLKDS</sub>		
<b>Audio Data Input Timing Information</b>					
ADCLRC/DACLRC propagation delay from BCLK falling edge	t <sub>DL</sub>			10	ns
ADCDAT propagation delay from BCLK falling edge	t <sub>DDA</sub>			10	ns
DACDAT setup time to BCLK rising edge	t <sub>DST</sub>	10			ns
DACDAT hold time from BCLK rising edge	t <sub>DHT</sub>	10			ns

**AUDIO INTERFACE TIMING – SLAVE MODE**

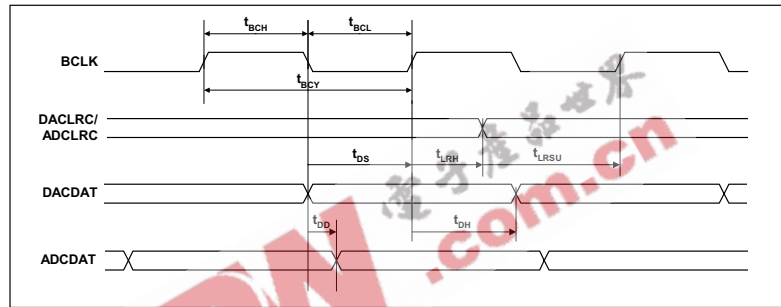

Figure 3 Digital Audio Data Timing – Slave Mode

**Test Conditions**

DCVDD = 1.42V, DBVDD = 3.3V, DGND = 0V, T<sub>A</sub> = +25°C, Slave Mode, fs = 48kHz, MCLK = 256fs, 24-bit data, unless otherwise stated.

PARAMETER	SYMBOL	MIN	TYP	MAX	UNIT
<b>Audio Data Input Timing Information</b>					
BCLK cycle time	t <sub>BCY</sub>	50			ns
BCLK pulse width high	t <sub>BCH</sub>	20			ns
BCLK pulse width low	t <sub>BCL</sub>	20			ns
ADCLRC/DACLRC set-up time to BCLK rising edge	t <sub>LRSU</sub>	10			ns
ADCLRC/DACLRC hold time from BCLK rising edge	t <sub>LRH</sub>	10			ns
DACDAT hold time from BCLK rising edge	t <sub>DH</sub>	10			ns
ADCDAT propagation delay from BCLK falling edge	t <sub>DD</sub>			10	ns

**Note:**

BCLK period should always be greater than or equal to MCLK period.

**CONTROL INTERFACE TIMING – 3-WIRE MODE**

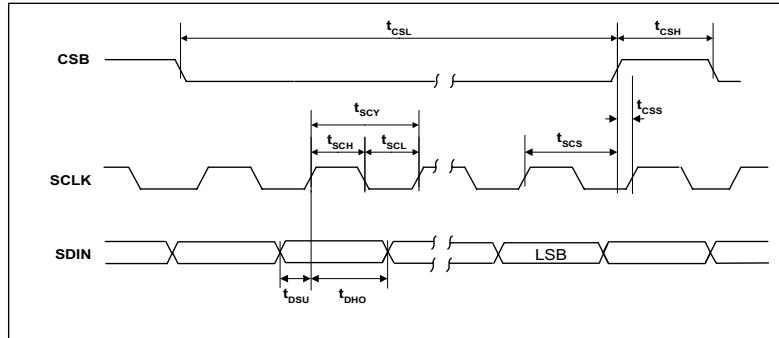

**Figure 4 Control Interface Timing – 3-Wire Serial Control Mode**

**Test Conditions**

DCVDD = 1.42V, DBVDD = 3.3V, DGND = 0V,  $T_A = +25^{\circ}C$ , Slave Mode, fs = 48kHz, MCLK = 256fs, 24-bit data, unless otherwise stated.

PARAMETER	SYMBOL	MIN	TYP	MAX	UNIT
<b>Program Register Input Information</b>					
SCLK rising edge to CSB rising edge	$t_{SCS}$	80			ns
SCLK pulse cycle time	$t_{SCY}$	200			ns
SCLK pulse width low	$t_{SCL}$	80			ns
SCLK pulse width high	$t_{SCH}$	80			ns
SDIN to SCLK set-up time	$t_{DSU}$	40			ns
SCLK to SDIN hold time	$t_{DHO}$	40			ns
CSB pulse width low	$t_{CSL}$	40			ns
CSB pulse width high	$t_{CSH}$	40			ns
CSB rising to SCLK rising	$t_{CSS}$	40			ns
Pulse width of spikes that will be suppressed	$t_{ps}$	5			ns

**CONTROL INTERFACE TIMING – 2-WIRE MODE**

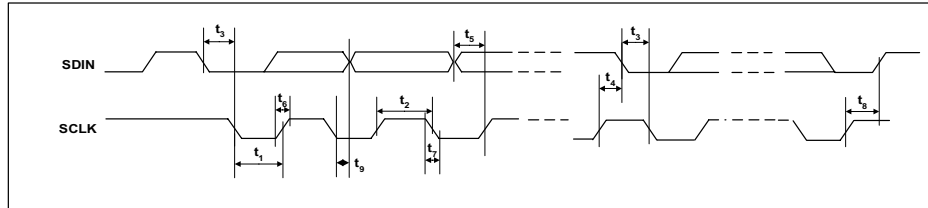

**Figure 5 Control Interface Timing – 2-Wire Serial Control Mode**

**Test Conditions**

DCVDD = 1.42V, DBVDD = 3.3V, DGND = 0V,  $T_A$  = +25°C, Slave Mode,  $f_s$  = 48kHz, MCLK = 256fs, 24-bit data, unless otherwise stated.

PARAMETER	SYMBOL	MIN	TYP	MAX	UNIT
<b>Program Register Input Information</b>					
SCLK Frequency		0		400	kHz
SCLK Low Pulse-Width	$t_1$	600			ns
SCLK High Pulse-Width	$t_2$	1.3			us
Hold Time (Start Condition)	$t_3$	600			ns
Setup Time (Start Condition)	$t_4$	600			ns
Data Setup Time	$t_5$	100			ns
SDIN, SCLK Rise Time	$t_6$			300	ns
SDIN, SCLK Fall Time	$t_7$			300	ns
Setup Time (Stop Condition)	$t_8$	600			ns
Data Hold Time	$t_9$			900	ns
Pulse width of spikes that will be suppressed	$t_{ps}$	0		5	ns

## DEVICE DESCRIPTION

### INTRODUCTION

The WM8972L is a low power audio CODEC offering a combination of high quality audio, advanced features, low power and small size. These characteristics make it ideal for portable digital audio applications such as digital still cameras and toys.

The device includes two differential analogue inputs that can be switched internally. Each can be used as either a line level input or microphone input and INPUT1+/INPUT1- and INPUT2+/INPUT2- can be configured as mono differential inputs. A programmable gain amplifier with automatic level control (ALC) keeps the recording volume constant. The on-chip ADC and DAC are of a high quality using a multi-bit, low-order oversampling architecture to deliver optimum performance with low power consumption.

The DAC output signal first enters an analogue mixer where an analogue input and/or the post-ALC signal can be added to it.

The WM8972L has a configurable digital audio interface where ADC data can be read and digital audio playback data fed to the DAC. It supports a number of audio data formats including I<sup>2</sup>S, DSP Mode (a burst mode in which frame sync plus 2 data packed words are transmitted), MSB-First, left justified and MSB-First and right justified. It can operate in master or slave modes.

The WM8972L uses a unique clocking scheme that can generate many commonly used audio sample rates from either a 12.00MHz USB clock or an industry standard 256/384 f<sub>s</sub> clock. This feature eliminates the common requirement for an external phase-locked loop (PLL) in applications where the master clock is not an integer multiple of the sample rate. Sample rates of 8kHz, 11.025kHz, 12kHz, 16kHz, 22.05kHz, 24kHz, 32kHz, 44.1kHz, 48kHz, 88.2kHz and 96kHz can be generated. The digital filters used for recording and playback are optimised for each sampling rate used.

To allow full software control over all its features, the WM8972L offers a choice of 2 or 3 wire MPU control interface. It is fully compatible with and an ideal partner for a wide range of industry standard microprocessors, controllers and DSPs.

The design of the WM8972L has given much attention to power consumption without compromising performance. It operates at very low voltages, and includes the ability to power off parts of the circuitry under software control, including standby and power off modes.

### INPUT SIGNAL PATH

The input signal path for each channel consists of a switch to select between two analogue inputs, followed by a PGA (programmable gain amplifier) and an optional microphone gain boost. A differential input of either (INPUT1+ – INPUT1-) or (INPUT2+ – INPUT2-) may also be selected. The gain of the PGA can be controlled either by the user or by the on-chip ALC function (see Automatic Level Control). The signal then enters an ADC where it is digitised.

#### SIGNAL INPUTS

The WM8972L has two sets of high impedance, low capacitance AC coupled analogue inputs, INPUT1+/INPUT1- and INPUT2+/INPUT2-. Inputs can be configured as microphone or line level by enabling or disabling the microphone gain boost.

The INSEL control bits (see Table 2) are used to select independently between external inputs and internally generated differential products. The choice of differential signal, INPUT1+ – INPUT1- or INPUT2+ – INPUT2- is made using DS (refer to Table 3).

As an example, the WM8972L can be set up to convert one differential input and route a single ended signal through the bypass path to the output mixing stage. This is done by applying the differential signal to INPUT1+ and INPUT1- and the single ended signal to INPUT2-. By setting DS to INPUT1+ and INPUT1- (see Table 3) and +/-MIXSEL to INPUT2+/-, each mono signal can be routed separately.

The inputs can also be configured as BEEP inputs by selecting the bypass path directly to the output mixing stage. Two BEEP inputs are available if the bypass mode is not used for audio signals, otherwise one BEEP input is available.

The signal inputs are biased internally to the reference voltage VREF. Whenever the line inputs are muted or the device placed into standby mode, the inputs are kept biased to VREF using special anti-thump circuitry. This reduces any audible clicks that may otherwise be heard when changing inputs.

REGISTER ADDRESS	BIT	LABEL	DEFAULT	DESCRIPTION
R32 (20h) ADC Signal Path Control	7:6	INSEL	00	Input Select 00 = INPUT1 01 = INPUT2 11 = L-R Differential (either INPUT1+ – INPUT1- or INPUT2+ – INPUT2-, selected by DS)
	5:4	MICBOOST	00	Microphone Gain Boost 00 = Boost off (bypassed) 01 = 13dB boost 10 = 20dB boost 11 = 29dB boost

Table 2 Input Software Control

REGISTER ADDRESS	BIT	LABEL	DEFAULT	DESCRIPTION
R31 (1Fh) ADC Input Mode	8	DS	0	Differential input select 0: INPUT1+ – INPUT1- 1: INPUT2+ – INPUT2-

Table 3 Differential Input Select

The MICBIAS output provides a low noise reference voltage suitable for biasing electret type microphones and the associated external resistor biasing network. Refer to the Applications Information section for recommended external components. The output can be enabled or disabled using the MICB control bit (see also the "Power Management" section).

REGISTER ADDRESS	BIT	LABEL	DEFAULT	DESCRIPTION
R25 (19h) Power Management (1)	1	MICB	0	Microphone Bias Enable 0 = OFF (high impedance output) 1 = ON

Table 4 Microphone Bias Control

The internal MICBIAS circuitry is shown below. Note that there is a maximum source current capability for MICBIAS of 3mA. The external biasing resistors therefore must be large enough to limit the MICBIAS current to 3mA.

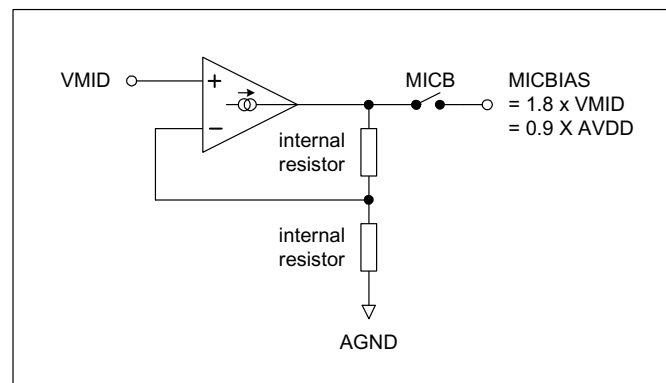

Figure 6 Microphone Bias Schematic

### PGA CONTROL

The PGA matches the input signal level to the ADC input range. The PGA gain is logarithmically adjustable from +30dB to -17.25dB in 0.75dB steps. The PGA can be controlled either by the user or by the ALC function (see Automatic Level Control). When ALC is enabled then writing to the PGA control register has no effect.

Setting the ZCEN bit enables a zero-cross detector which ensures that PGA gain changes only occur when the signal is at zero, eliminating any zipper noise. If zero cross is enabled a timeout is also available to update the gain if a zero cross does not occur. This function may be enabled by setting TOEN in register R23 (17h).

The inputs can also be muted in the analogue domain under software control. The software control registers are shown in Table 5. If zero crossing is enabled, it is necessary to enable zero cross timeout to un-mute the input PGAs. This is because their outputs will not cross zero when muted. Alternatively, zero cross can be disabled before sending the un-mute command.

REGISTER ADDRESS	BIT	LABEL	DEFAULT	DESCRIPTION
R0 (00h) PGA	8	IVU	0	Volume Update 0 = Store INVOL in intermediate latch (no gain change) 1 = Update gains
	7	INMUTE	1	Analogue Mute 1 = Enable Mute 0 = Disable Mute Note: IVU must be set to un-mute.
	6	ZCEN	0	Zero Cross Detector 1 = Change gain on zero cross only 0 = Change gain immediately
	5:0	INVOL [5:0]	010111 (0dB)	Input Volume Control 111111 = +30dB 111110 = +29.25dB .. 0.75dB steps down to 000000 = -17.25dB
R23 (17h) Additional Control (1)	0	TOEN	0	Timeout Enable 0 : Timeout Disabled 1 : Timeout Enabled

Table 5 Input PGA Software Control

**ANALOGUE TO DIGITAL CONVERTER (ADC)**

The WM8972L uses a multi-bit, oversampled sigma-delta ADC. The use of multi-bit feedback and high oversampling rates reduces the effects of jitter and high frequency noise. The ADC Full Scale input level is proportional to AVDD. With a 3.3V supply voltage, the full scale level is 1.0 Volt r.m.s. Any voltage greater than full scale may overload the ADC and cause distortion.

**ADC DIGITAL FILTER**

The ADC filters perform true 24 bit signal processing to convert the raw multi-bit oversampled data from the ADC to the correct sampling frequency to be output on the digital audio interface. The digital filter path is illustrated in Figure 7.

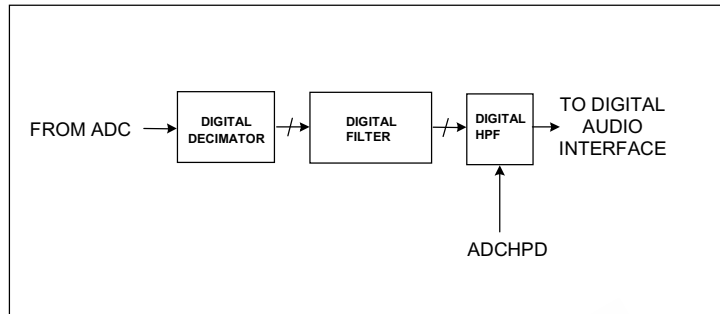

**Figure 7 ADC Digital Filter**

The ADC digital filters contain a digital high pass filter, selectable via software control. The high-pass filter response is detailed in the Digital Filter Characteristics section. When the high-pass filter is enabled the dc offset is continuously calculated and subtracted from the input signal. By setting HPOR, the last calculated dc offset value is stored when the high-pass filter is disabled and will continue to be subtracted from the input signal. If the DC offset is changed, the stored and subtracted value will not change unless the high-pass filter is enabled. This feature can be used for calibration purposes.

The output data format can be programmed by the user. The polarity of the output signal can also be changed under software control. The software control is shown in Table 6.

REGISTER ADDRESS	BIT	LABEL	DEFAULT	DESCRIPTION
R5 (05h) ADC and DAC Control	5	ADCPOL	0	0 = Polarity not inverted 1 = Polarity invert
	4	HPOR	0	Store dc offset when High Pass Filter disabled 1 = store offset 0 = clear offset
	0	ADCHPD	0	ADC High Pass Filter Enable (Digital) 1 = Disable High Pass Filter 0 = Enable High Pass Filter

**Table 6 ADC Signal Path Control**



**DIGITAL ADC VOLUME CONTROL**

The output of the ADC can be digitally amplified or attenuated over a range from -97dB to +30dB in 0.5dB steps. The gain for a given eight-bit code X is given by:

$$0.5 \times (X-195) \text{ dB for } 1 \leq X \leq 255; \quad \text{MUTE for } X = 0$$

The AVU control bit controls the loading of digital volume control data. When AVU is set to 0, the ADCVOL control data will be loaded into the control register, but will not actually change the digital gain setting. Gain settings are updated when AVU is set to 1.

REGISTER ADDRESS	BIT	LABEL	DEFAULT	DESCRIPTION
R21 (15h) ADC Digital Volume	7:0	ADCVOL [7:0]	11000011 ( 0dB )	ADC Digital Volume Control 0000 0000 = Digital Mute 0000 0001 = -97dB 0000 0010 = -96.5dB ... 0.5dB steps up to 1111 1111 = +30dB
	8	AVU	0	ADC Volume Update 0 = Store ADCVOL in intermediate latch (no gain change) 1 = Update gains ( = ADCVOL)

Table 7 ADC Digital Volume Control

EEPW.com.cn 电子產品世界

## AUTOMATIC LEVEL CONTROL (ALC)

The WM8750L has an automatic level control that aims to keep a constant recording volume irrespective of the input signal level. This is achieved by continuously adjusting the PGA gain so that the signal level at the ADC input remains constant. A digital peak detector monitors the ADC output and changes the PGA gain if necessary. Note that when the ALC function is enabled, the settings of registers 0 and 1 (LINVOL, LIVU, LIZC, LINMUTE, RINVOL, RIVU, RIZC and RINMUTE) are ignored.

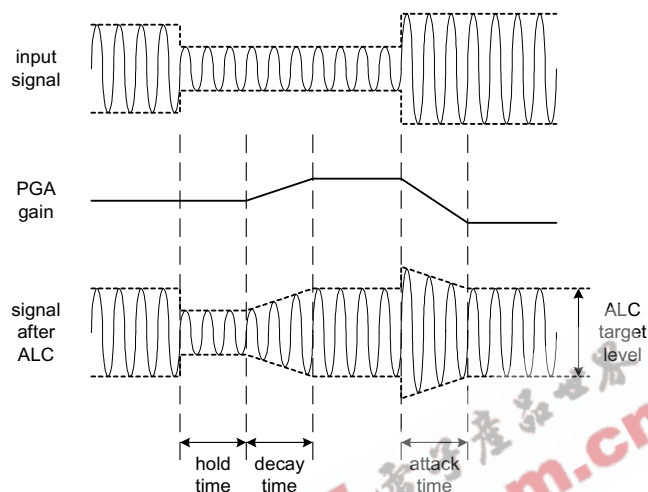

**Figure 8 ALC Operation**

The ALC function is enabled using the ALCSEL control bits. When enabled, the recording volume can be programmed between  $-6\text{dB}$  and  $-28.5\text{dB}$  (relative to ADC full scale) using the ALCL register bits. An upper limit for the PGA gain can be imposed by setting the MAXGAIN control bits.

HLD, DCY and ATK control the hold, decay and attack times, respectively:

**Hold** time is the time delay between the peak level detected being below target and the PGA gain beginning to ramp up. It can be programmed in power-of-two ( $2^n$ ) steps, e.g. 2.67ms, 5.33ms, 10.67ms etc. up to 43.7s. Alternatively, the hold time can also be set to zero. The hold time only applies to gain ramp-up, there is no delay before ramping the gain down when the signal level is above target.

**Decay (Gain Ramp-Up)** Time is the time that it takes for the PGA gain to ramp up across 90% of its range (e.g. from  $-15\text{B}$  up to  $27.75\text{dB}$ ). The time it takes for the recording level to return to its target value therefore depends on both the decay time and on the gain adjustment required. If the gain adjustment is small, it will be shorter than the decay time. The decay time can be programmed in power-of-two ( $2^n$ ) steps, from 24ms, 48ms, 96ms, etc. to 24.58s.

**Attack (Gain Ramp-Down)** Time is the time that it takes for the PGA gain to ramp down across 90% of its range (e.g. from  $27.75\text{dB}$  down to  $-15\text{B}$  gain). The time it takes for the recording level to return to its target value therefore depends on both the attack time and on the gain adjustment required. If the gain adjustment is small, it will be shorter than the attack time. The attack time can be programmed in power-of-two ( $2^n$ ) steps, from 6ms, 12ms, 24ms, etc. to 6.14s.

REGISTER ADDRESS	BIT	LABEL	DEFAULT	DESCRIPTION
R17 (11h) ALC Control 1	8	ALCSEL	0 (OFF)	ALC function select 0 = ALC off (PGA gain set by register) 1 = ALC on
	6:4	MAXGAIN [2:0]	111 (+30dB)	Set Maximum Gain of PGA 111 : +30dB 110 : +24dB ...(-6dB steps) 001 : -6dB 000 : -12dB
	3:0	ALCL [3:0]	1011 (-12dB)	ALC target – sets signal level at ADC input 0000 = -28.5dB FS 0001 = -27.0dB FS ... (1.5dB steps) 1110 = -7.5dB FS 1111 = -6dB FS
R18 (12h) ALC Control 2	7	ALCZC	0 (zero cross off)	ALC uses zero cross detection circuit.
	3:0	HLD [3:0]	0000 (0ms)	ALC hold time before gain is increased. 0000 = 0ms 0001 = 2.67ms 0010 = 5.33ms ... (time doubles with every step) 1111 = 43.691s
R19 (13h) ALC Control 3	7:4	DCY [3:0]	0011 (192ms)	ALC decay (gain ramp-up) time 0000 = 24ms 0001 = 48ms 0010 = 96ms ... (time doubles with every step) 1010 or higher = 24.58s
	3:0	ATK [3:0]	0010 (24ms)	ALC attack (gain ramp-down) time 0000 = 6ms 0001 = 12ms 0010 = 24ms ... (time doubles with every step) 1010 or higher = 6.14s

Table 8 ALC Control

**PEAK LIMITER**

To prevent clipping when a large signal occurs just after a period of quiet, the ALC circuit includes a limiter function. If the ADC input signal exceeds 87.5% of full scale (-1.16dB), the PGA gain is ramped down at the maximum attack rate (as when ATK = 0000), until the signal level falls below 87.5% of full scale. This function is automatically enabled whenever the ALC is enabled.

**Note:**

If ATK = 0000, then the limiter makes no difference to the operation of the ALC. It is designed to prevent clipping when long attack times are used.

### NOISE GATE

When the signal is very quiet and consists mainly of noise, the ALC function may cause “noise pumping”, i.e. loud hissing noise during silence periods. The WM8972L has a noise gate function that prevents noise pumping by comparing the signal level at the INPUT1+ and/or INPUT2+ pins against a noise gate threshold, NGTH. The noise gate cuts in when:

- Signal level at ADC [dB] < NGTH [dB] + PGA gain [dB] + Mic Boost gain [dB]

This is equivalent to:

- Signal level at input pin [dB] < NGTH [dB]

The ADC output can then either be muted or the PGA gain can be held constant (preventing it from ramping up as it normally would when the signal is quiet).

The table below summarises the noise gate control register. The NGTH control bits set the noise gate threshold with respect to the ADC full-scale range. The threshold is adjusted in 1.5dB steps. Levels at the extremes of the range may cause inappropriate operation, so care should be taken with set-up of the function. Note that the noise gate only works in conjunction with the ALC function.

REGISTER ADDRESS	BIT	LABEL	DEFAULT	DESCRIPTION
R20 (14h) Noise Gate Control	7:3	NGTH [4:0]	00000	Noise gate threshold 00000 -76.5dBfs 00001 -75dBfs ... 1.5 dB steps 11110 -31.5dBfs 11111 -30dBfs
	2:1	NGG [1:0]	00	Noise gate type X0 = PGA gain held constant 01 = mute ADC output 11 = reserved (do not use this setting)
	0	NGAT	0	Noise gate function enable 1 = enable 0 = disable

**Table 9 Noise Gate Control**

**Note:**

The performance of the ADC may degrade at high input signal levels if the monitor bypass mux is selected with MIC boost and ALC enabled.

## OUTPUT SIGNAL PATH

The WM8972L output signal paths consist of digital filters, a DAC, analogue mixers and output drivers. The digital filters and DAC are enabled when the WM8972L is in 'playback only' or 'record and playback' mode. The mixers and output drivers can be separately enabled by individual control bits (see Analogue Outputs). Thus it is possible to utilise the analogue mixing and amplification provided by the WM8972L, irrespective of whether the DAC is running or not.

The WM8972L receives digital input data on the DACDAT pin. The digital filter block processes the data to provide the following functions:

- Digital volume control
- Graphic equaliser and Dynamic Bass Boost
- Sigma-Delta Modulation

A high performance sigma-delta audio DAC converts the digital data into two analogue signals (left and right). These can then be mixed with analogue signals from the INPUT1+/2+ and INPUT1-/2- pins, and the mix is fed to the output drivers, OUT+/OUT-, OUT2 and MONOOUT.

- OUT2: can drive a 16Ω or 32Ω headphone or line output.
- OUT+/OUT-: can drive a 16Ω or 32Ω headphone or line output, or an 8Ω mono speaker.
- MONOOUT: can drive a mono line output or other load down to 10kΩ

## DIGITAL DAC VOLUME CONTROL

The signal volume from the DAC can be controlled digitally, in the same way as the ADC volume (see Digital ADC Volume Control). The gain and attenuation range is -127dB to 0dB in 0.5dB steps. The level of attenuation for an eight-bit code X is given by:

$$0.5 \times (X-255) \text{ dB for } 1 \leq X \leq 255; \quad \text{MUTE for } X = 0$$

The DVU control bit controls the loading of digital volume control data. When DVU is set to 0, the DACVOL control data is loaded into an intermediate register, but the actual gain does not change. The gain settings are updated simultaneously when DVU is set to 1.

REGISTER ADDRESS	BIT	LABEL	DEFAULT	DESCRIPTION
R10 (0Ah) Digital Volume	8	DVU	0	DAC Volume Update 0 = Store DACVOL in intermediate latch (no gain change) 1 = Update gains
	7:0	DACVOL [7:0]	11111111 ( 0dB )	DAC Digital Volume Control 0000 0000 = Digital Mute 0000 0001 = -127dB 0000 0010 = -126.5dB ... 0.5dB steps up to 1111 1111 = 0dB

Table 10 Digital Volume Control

## GRAPHIC EQUALISER

The WM8972L has a digital graphic equaliser and adaptive bass boost function. This function operates on digital audio data before it is passed to the audio DAC. Bass enhancement can take two different forms:

- Linear bass control: bass signals are amplified or attenuated by a user programmable gain. This is independent of signal volume, and very high bass gains on loud signals may lead to signal clipping.
- Adaptive bass boost: The bass volume is amplified by a variable gain. When the bass volume is low, it is boosted more than when the bass volume is high. This method is recommended because it prevents clipping, and usually sounds more pleasant to the human ear.

Treble control applies a user programmable gain, without any adaptive boost function. Bass and treble control are completely independent with separately programmable gains and filter characteristics.

REGISTER ADDRESS	BIT	LABEL	DEFAULT	DESCRIPTION		
R12 (0Ch) Bass Control	7	BB	0	Bass Boost 0 = Linear bass control 1 = Adaptive bass boost		
	6	BC	0	Bass Filter Characteristic 0 = Low Cutoff (130Hz at 48kHz sampling) 1 = High Cutoff (200Hz at 48kHz sampling)		
	3:0	BASS [3:0]	1111 (Disabled)	Bass Intensity		
				Code	BB=0	BB=1
				0000	+9dB	15 (max)
				0001	+9dB	14
				0010	+7.5dB	13
				0011	+6dB	12
				0100	+4.5dB	11
				0101	+3dB	10
				0110	+1.5dB	9
				0111	0dB	8
				1000	-1.5dB	7
				1001	-3dB	6
1010	-4.5dB	5				
1011	-6dB	4				
1100	-6dB	3				
1101	-6dB	2				
1110	-6dB	1				
1111	Bypass (OFF)					
R13 (0Dh) Treble Control	6	TC	0	Treble Filter Characteristic 0 = High Cutoff (8kHz at 48kHz sampling) 1 = Low Cutoff (4kHz at 48kHz sampling)		
	3:0	TRBL [3:0]	1111 (Disabled)	Treble Intensity 0000 or 0001 = +9dB 0010 = +7.5dB ... (1.5dB steps) 1011 to 1110 = -6dB 1111 = Disable		

Table 11 Graphic Equaliser

**DIGITAL TO ANALOGUE CONVERTER (DAC)**

After passing through the graphic equaliser filters, digital 'de-emphasis' can be applied to the audio data if necessary (e.g. when the data comes from a CD with pre-emphasis used in the recording). De-emphasis filtering is available for sample rates of 48kHz, 44.1kHz and 32kHz.

The WM8972L also has a Soft Mute function, which gradually attenuates the volume of the digital signal to zero. When removed, the gain will ramp back up to the digital gain setting. This function is enabled by default. To play back an audio signal, it must first be disabled by setting the DACMU bit to zero.

REGISTER ADDRESS	BIT	LABEL	DEFAULT	DESCRIPTION
R5 (05h) ADC and DAC Control	2:1	DEEMP [1:0]	00	De-emphasis Control 11 = 48kHz sample rate 10 = 44.1kHz sample rate 01 = 32kHz sample rate 00 = No De-emphasis
	3	DACMU	1	Digital Soft Mute 1 = mute 0 = no mute (signal active)

**Table 12 DAC Control**

The digital audio data is converted to oversampled bit streams in the on-chip, true 24-bit digital interpolation filters. The bitstream data enters two multi-bit, sigma-delta DACs, which convert them to high quality analogue audio signals. The multi-bit DAC architecture reduces high frequency noise and sensitivity to clock jitter. It also uses a Dynamic Element Matching technique for high linearity and low distortion.

The DAC output defaults to non-inverted. Setting DACINV will invert the DAC output phase on both left and right channels.

REGISTER ADDRESS	BIT	LABEL	DEFAULT	DESCRIPTION
R23 (17h) Additional Control (1)	1	DACINV	0	DAC phase invert 0 : non-inverted 1 : inverted

**Table 13 Phase Invert Select**

**OUTPUT MIXERS**

The WM8972L provides the option to mix the DAC output signal with analogue line-in signals from the INPUT1+/- or INPUT2+/- pins or a mono differential input (INPUT1+ – INPUT1-) or (INPUT2+ – INPUT2-), selected by DS (see Table 3). The level of the mixed-in signals can be controlled with PGA (Programmable Gain Amplifier).

REGISTER ADDRESS	BIT	LABEL	DEFAULT	DESCRIPTION
R34 (22h) Plus Mixer (1)	2:0	+MIXSEL	000	Plus Input Selection for Output Mix 000 = INPUT1+ 001 = INPUT2+ 011 = ADC Input (after PGA / MICBOOST) 100 = Differential input
R36 (24h) Minus Mixer (1)	2:0	-MIXSEL	000	Minus Input Selection for Output Mix 000 = INPUT1- 001 = INPUT2- 011 = RESERVED (Do not use) 100 = Differential input

**Table 14 Output Mixer Signal Selection**

REGISTER ADDRESS	BIT	LABEL	DEFAULT	DESCRIPTION
R34 (22h) Plus Mixer Control (1)	8	D2+MO	0	DAC to Plus Mixer 0 = Disable (Mute) 1 = Enable Path
	7	+M2+MO	0	+MIXSEL Signal to Plus Mixer 0 = Disable (Mute) 1 = Enable Path
	6:4	+M2+MOVOL [2:0]	101 (-9dB)	+MIXSEL Signal to Plus Mixer Volume 000 = +6dB ... (3dB steps) 111 = -15dB
R35 (23h) Plus Mixer Control (2)	7	-M2+MO	0	-MIXSEL Signal to Plus Mixer 0 = Disable (Mute) 1 = Enable Path
	6:4	-M2+MOVOL [2:0]	101 (-9dB)	-MIXSEL Signal to Plus Mixer Volume 000 = +6dB ... (3dB steps) 111 = -15dB

**Table 15 Plus Output Mixer Control**



REGISTER ADDRESS	BIT	LABEL	DEFAULT	DESCRIPTION
R36 (24h) Minus Mixer Control (1)	8	D2-MO	0	DAC to Minus Mixer 0 = Disable (Mute) 1 = Enable Path
	7	+M2-MO	0	+MIXSEL Signal to Minus Mixer 0 = Disable (Mute) 1 = Enable Path
	6:4	+M2-MOVOL [2:0]	101 (-9dB)	+MIXSEL Signal to Minus Mixer Volume 000 = +6dB ... (3dB steps) 111 = -15dB
R37 (25h) Minus Mixer Control (2)	7	-M2-MO	0	-MIXSEL Signal to Minus Mixer 0 = Disable (Mute) 1 = Enable Path
	6:4	-M2-MOVOL [2:0]	101 (-9dB)	-MIXSEL Signal to Minus Mixer Volume 000 = +6dB ... (3dB steps) 111 = -15dB

Table 16 Minus Output Mixer Control

REGISTER ADDRESS	BIT	LABEL	DEFAULT	DESCRIPTION
R38 (26h) Mono Mixer Control (1)	8	D2MO	0	DAC to Mono Mixer 0 = Disable (Mute) 1 = Enable Path
	7	+M2MO	0	+MIXSEL Signal to Mono Mixer 0 = Disable (Mute) 1 = Enable Path
	6:4	+M2MOVOL [2:0]	101 (-9dB)	+MIXSEL Signal to Mono Mixer Volume 000 = +6dB ... (3dB steps) 111 = -15dB
R39 (27h) Mono Mixer Control (2)	7	-M2MO	0	-MIXSEL Signal to Mono Mixer 0 = Disable (Mute) 1 = Enable Path
	6:4	-M2MOVOL [2:0]	101 (-9dB)	-MIXSEL Signal to Mono Mixer Volume 000 = +6dB ... (3dB steps) 111 = -15dB

Table 17 Mono Output Mixer Control

## ANALOGUE OUTPUTS

### OUT+/OUT- OUTPUTS

The OUT+ and OUT- output pins are independently controlled and can drive an 8Ω mono speaker (see Speaker Output section). For speaker drive, the OUT- signal must be inverted (OUTINV = 1), so that the two signals are mixed to mono in the speaker [OUT+ – (-OUT-) = OUT+ + OUT-].

REGISTER ADDRESS	BIT	LABEL	DEFAULT	DESCRIPTION
R40 (28h) OUT+ Volume	6:0	+OUTVOL [6:0]	1111001 (0dB)	OUT+ Volume 1111111 = +6dB ... (80 steps) 0110000 = -67dB 0101111 to 0000000 = Analogue MUTE
	7	+OZC	0	OUT+ zero cross enable 1 = Change gain on zero cross only 0 = Change gain immediately
	8	+OVU	0	OUT+ Volume Update 0 = Store +OUTVOL in intermediate latch (no gain change) 1 = Update gains
R41 (29h) OUT- Volume	6:0	-OUTVOL [6:0]	1111001 (0dB)	OUT- Volume 1111111 = +6dB ... (80 steps) 0110000 = -67dB 0101111 to 0000000 = Analogue MUTE
	7	-OZC	0	OUT- zero cross enable 1 = Change gain on zero cross only 0 = Change gain immediately
	8	-OVU	0	OUT- Volume Update 0 = Store -OUTVOL in intermediate latch (no gain change) 1 = Update gains
R24 (18h) Additional Control (2)	4	OUTINV	0	OUT- Invert 0 = No Inversion (0° phase shift) 1 = Signal inverted (180° phase shift)

Table 18 OUT+/OUT- Volume Control

### MONO OUTPUT

The MONOOUT pin can drive a mono line output. The signal volume on MONOOUT can be adjusted under software control by writing to MONOOUTVOL.

REGISTER ADDRESS	BIT	LABEL	DEFAULT	DESCRIPTION
R42 (2Ah) MONOOUT Volume	6:0	MONOOUT VOL [6:0]	1111001 (0dB)	MONOOUT Volume 1111111 = +6dB ... (80 steps) 0110000 = -67dB 0101111 to 0000000 = Analogue MUTE
	7	MOZC	0	MONOOUT zero cross enable 1 = Change gain on zero cross only 0 = Change gain immediately

Table 19 MONOOUT Volume Control

### OUT2 OUTPUT

The OUT2 pin can drive a 16Ω or 32Ω headphone or a line output or be used as a DC reference for a headphone output (see Headphone Output section). It can be selected to either drive out an inverted OUT- or inverted MONOOUT for e.g. a differential output between OUT2 and MONOOUT.

OUT2SW selects the mode of operation required.

REGISTER ADDRESS	BIT	LABEL	DEFAULT	DESCRIPTION
R24 (18h) Additional Control (2)	8:7	OUT2SW [1:0]	00	OUT2 select 00 : VREF 01 : RESERVED (Do not use) 10 : MONOOUT 11 : minus mixer output (no volume control through -OUTVOL)

Table 20 OUT2 Select

### ENABLING THE OUTPUTS

Each analogue output of the WM8972L can be separately enabled or disabled. The analogue mixer associated with each output is powered on or off along with the output pin. All outputs are disabled by default. To save power, unused outputs should remain disabled.

Outputs can be enabled at any time, except when VREF is disabled (VR=0), as this may cause pop noise (see "Power Management" and "Applications Information" sections)

REGISTER ADDRESS	BIT	LABEL	DEFAULT	DESCRIPTION
R26 (1Ah) Power Management (2)	4	OUT+	0	OUT+ Enable
	3	OUT-	0	OUT- Enable
	2	MONO	0	MONOOUT Enable
	1	OUT2	0	OUT2 Enable

Table 21 Analogue Output Control

Whenever an analogue output is disabled, it remains connected to VREF (pin 20) through a resistor. This helps to prevent pop noise when the output is re-enabled. The resistance between VREF and each output can be controlled using the VROI bit in register 27. The default is low (1.5kΩ), so that any capacitors on the outputs can charge up quickly at start-up. If a high impedance is desired for disabled outputs, VROI can then be set to 1, increasing the resistance to about 40kΩ.

REGISTER ADDRESS	BIT	LABEL	DEFAULT	DESCRIPTION
R27 (1Bh) Additional (1)	6	VROI	0	VREF to analogue output resistance 0: 1.5 kΩ 1: 40 kΩ

Table 22 Disabled Outputs to VREF Resistance

### THERMAL SHUTDOWN

The speaker output can drive very large currents. To protect the WM8972L from overheating a thermal shutdown circuit is included. If the device temperature reaches approximately 150°C and the thermal shutdown circuit is enabled (TSDEN = 1) then the speaker outputs will be disabled.

REGISTER ADDRESS	BIT	LABEL	DEFAULT	DESCRIPTION
R23 (17h) Additional Control (1)	8	TSDEN	0	Thermal Shutdown Enable 0 : thermal shutdown disabled 1 : thermal shutdown enabled

Table 23 Thermal Shutdown

### SPEAKER OUTPUT

OUT+ and OUT- can differentially drive a mono 8Ω speaker as shown below.

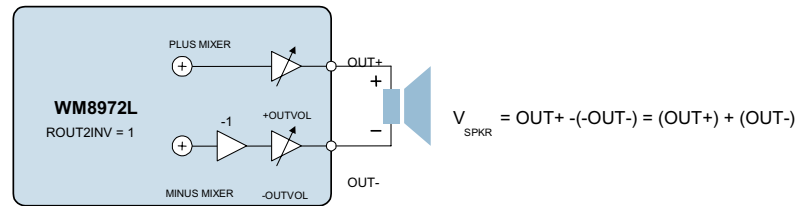
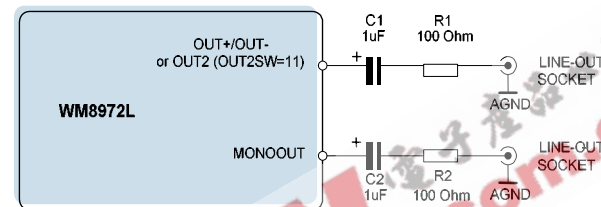

**Figure 9 Speaker Output Connection**

The OUT- channel is inverted by setting the OUTINV bit, so that the signal across the loudspeaker is the sum of OUT+ and OUT- signals.

### LINE OUTPUT

The analogue outputs OUT+/OUT- can be used as line outputs. Recommended external components are shown below.



**Figure 10 Recommended Circuit for Line Output**

The DC blocking capacitors and the load resistance together determine the lower cut-off frequency,  $f_c$ . Assuming a 10 kΩ load and  $C_1, C_2 = 1\mu\text{F}$ :

$$f_c = 1 / 2\pi (R_L + R_1) \quad C_1 = 1 / (2\pi \times 10.1\text{k}\Omega \times 1\mu\text{F}) = 16 \text{ Hz}$$

Increasing the capacitance lowers  $f_c$ , improving the bass response. Smaller values of  $C_1$  and  $C_2$  will diminish the bass response. The function of  $R_1$  and  $R_2$  is to protect the line outputs from damage when used improperly.

## DIGITAL AUDIO INTERFACE

The digital audio interface is used for inputting DAC data into the WM8972L and outputting ADC data from it. It uses five pins:

- ADCDAT: ADC data output
- ADCLRC: ADC data alignment clock
- DACDAT: DAC data input
- ADCLRC: DAC data alignment clock
- BCLK: Bit clock, for synchronisation

The clock signals BCLK, ADCLRC and DACLRC can be outputs when the WM8972L operates as a master, or inputs when it is a slave (see Master and Slave Mode Operation, below).

Four different audio data formats are supported:

- Left justified
- Right justified
- I<sup>2</sup>S
- DSP mode

All four of these modes are MSB first. They are described in Audio Data Formats, below. Refer to the Electrical Characteristic section for timing information.

**MASTER AND SLAVE MODE OPERATION**

The WM8972L can be configured as either a master or slave mode device. As a master device the WM8972L generates BCLK, ADCLRC and DACLRC and thus controls sequencing of the data transfer on ADCDAT and DACDAT. In slave mode, the WM8972L responds with data to clocks it receives over the digital audio interface. The mode can be selected by writing to the MS bit (see Table 23). Master and slave modes are illustrated below.

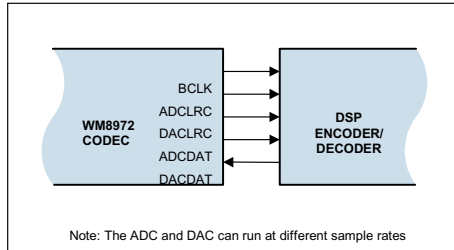

Figure 11 Master Mode

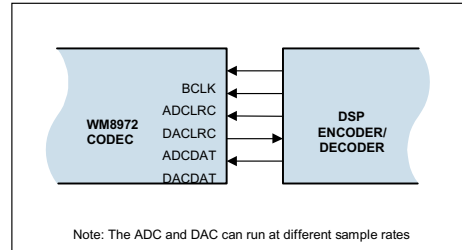

Figure 12 Slave Mode

**AUDIO DATA FORMATS**

The mono data is available during the left channel period of DACLRC/ADCLRC.

In Left Justified mode, the MSB is available on the first rising edge of BCLK following a LRCLK transition. The other bits up to the LSB are then transmitted in order. Depending on word length, BCLK frequency and sample rate, there may be unused BCLK cycles before each LRCLK transition.

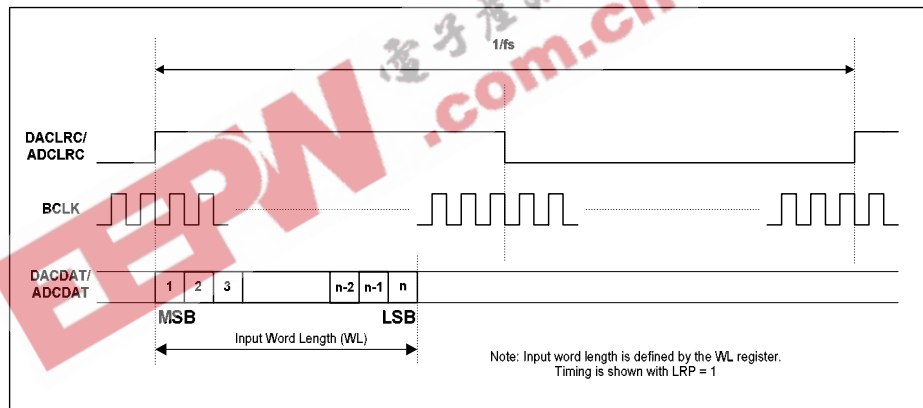

Figure 13 Left Justified Audio Interface (assuming n-bit word length)

In Right Justified mode, the LSB is available on the last rising edge of BCLK before a LRCLK transition. All other bits are transmitted before (MSB first). Depending on word length, BCLK frequency and sample rate, there may be unused BCLK cycles after each LRCLK transition.

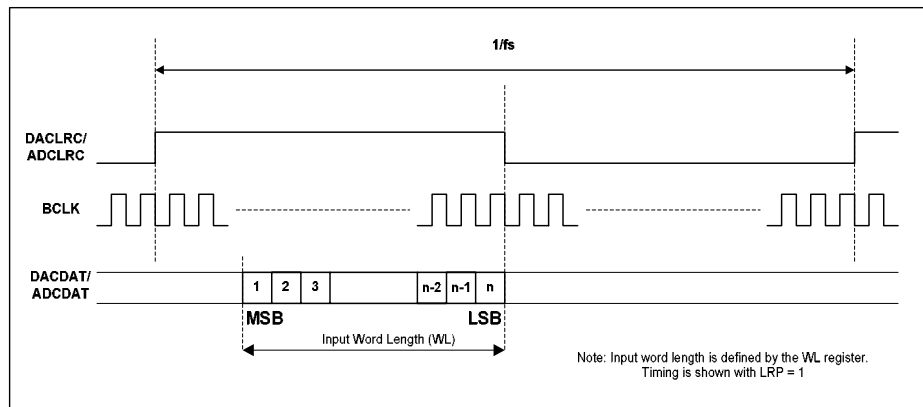

Figure 14 Right Justified Audio Interface (assuming n-bit word length)

In I<sup>2</sup>S mode, the MSB is available on the second rising edge of BCLK following a LRCLK transition. The other bits up to the LSB are then transmitted in order. Depending on word length, BCLK frequency and sample rate, there may be unused BCLK cycles between the LSB of one sample and the MSB of the next.

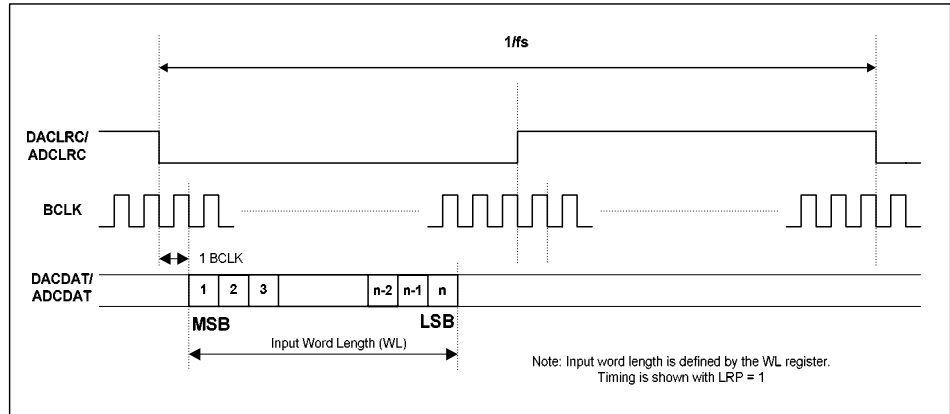

Figure 15 I<sup>2</sup>S Justified Audio Interface (assuming n-bit word length)

In DSP mode, the mono MSB is available on either the 1<sup>st</sup> (mode B) or 2<sup>nd</sup> (mode A) rising edge of BCLK (selectable by LRP) following a rising edge of LRCLK. Depending on word length, BCLK frequency and sample rate, there may be unused BCLK cycles between the LSB and the next sample.

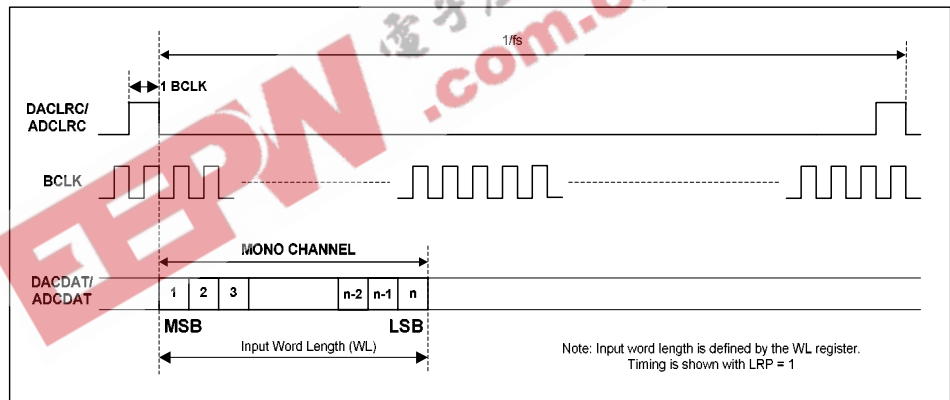

Figure 16 DSP Mode Audio Interface (mode A, LRP=0)

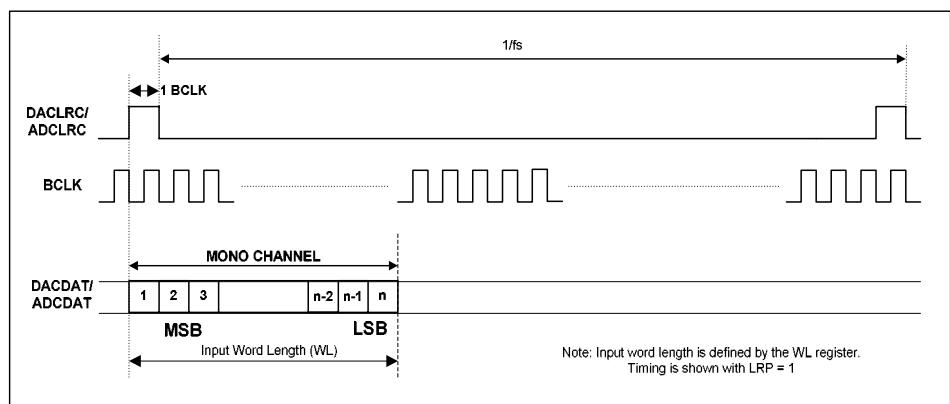

Figure 17 DSP Mode Audio Interface (mode B, LRP=1)

## AUDIO INTERFACE CONTROL

The register bits controlling audio format, word length and master / slave mode are summarised in Table 24. MS selects audio interface operation in master or slave mode. In Master mode BCLK, ADCLRC and DACLRC are outputs. The frequency of ADCLRC and DACLRC is set by the sample rate control bits SR[4:0] and USB. In Slave mode BCLK, ADCLRC and DACLRC are inputs.

REGISTER ADDRESS	BIT	LABEL	DEFAULT	DESCRIPTION
R7 (07h) Digital Audio Interface Format	7	BCLKINV	0	BCLK invert bit (for master & slave modes) 0 = BCLK not inverted 1 = BCLK inverted
	6	MS	0	Master / Slave Mode Control 1 = Enable Master Mode 0 = Enable Slave Mode
	4	LRP	0	right, left & i2s modes – LRCLK polarity 1 = invert LRCLK polarity 0 = normal LRCLK polarity
				DSP Mode – mode A/B select 1 = MSB is available on 1st BCLK rising edge after LRC rising edge (mode B) 0 = MSB is available on 2nd BCLK rising edge after LRC rising edge (mode A)
	3:2	WL[1:0]	10	Audio Data Word Length 11 = 32 bits (see Note) 10 = 24 bits 01 = 20 bits 00 = 16 bits
1:0	FORMAT[1:0]	10	Audio Data Format Select 11 = DSP Mode 10 = I <sup>2</sup> S Format 01 = Left justified 00 = Right justified	

Table 24 Audio Data Format Control

Note: Right Justified mode does not support 32-bit data.

## AUDIO INTERFACE OUTPUT TRISTATE

Register bit TRI, register 24(18h) bit[3] can be used to tristate the ADCDAT pin and switch ADCLRC, DACLRC and BCLK to inputs. In Slave mode (MASTER=0) ADCLRC, DACLRC and BCLK are by default configured as inputs and only ADCDAT will be tri-stated, (see Table 25).

REGISTER ADDRESS	BIT	LABEL	DEFAULT	DESCRIPTION
R24(18h) Additional Control (2)	3	TRI	0	Tristates ADCDAT and switches ADCLRC, DACLRC and BCLK to inputs. 0 = ADCDAT is an output, ADCLRC, DACLRC and BCLK are inputs (slave mode) or outputs (master mode) 1 = ADCDATE is tristated, ADCLRC, DACLRC and BCLK are inputs

Table 25 Tri-stating the Audio Interface

**MASTER MODE ADCLRC AND DACLRC ENABLE**

In Master mode, by default ADCLRC is disabled when the ADC is disabled and DACLRC is disabled when the DAC is disabled. Register bit LRCM, register 24(18h) bit[2] changes the control so that the ADCLRC and DACLRC are disabled only when ADC and DAC are disabled. This enables the user to use e.g. ADCLRC for both ADC and DAC LRCLK and disable the ADC when DAC only operation is required, (see Table 26).

REGISTER ADDRESS	BIT	LABEL	DEFAULT	DESCRIPTION
R24(18h) Additional Control (2)	2	LRCM	0	Selects disable mode for ADCLRC and DACLRC 0 = ADCLRC disabled when ADC disabled DACLRC disabled when DAC disabled 1 = ADCLRC and DACLRC disabled only when ADC and DAC are disabled.

Table 26 ADCLRC/DACLRC Enable

**CLOCK OUTPUT**

By default ADCLRC (pin 9) is the ADC word clock input/output. Under the control of ADCLRM[1:0], register 27(1Bh) bits [8:7] the ADCLRC pin may be configured as a clock output. If ADCLRM is 01, 10 or 11 then ADCLRC pin is always an output even in slave mode or when TRI = '1', (see Table 27).

REGISTER ADDRESS	BIT	LABEL	DEFAULT	DESCRIPTION
R27(1Bh) Additional Control (3)	[8:7]	ADCLRM [1:0]	00	Configures ADCLRC pin 00 = ADCLRC is ADC word clock input (slave mode) or ADCLRC output (master mode) 01 = ADCLRC pin is MCLK output 10 = ADCLRC pin is MCLK / 5.5 output 11 = ADCLRC pin is MCLK / 6 output

Table 27 ADCLRC Clock Output

**CLOCKING AND SAMPLE RATES**

The WM8972L supports a wide range of master clock frequencies on the MCLK pin, and can generate many commonly used audio sample rates directly from the master clock. The ADC and DAC do not need to run at the same sample rate; several different combinations are possible.

There are two clocking modes:

- 'Normal' mode supports master clocks of 128f<sub>s</sub>, 192f<sub>s</sub>, 256f<sub>s</sub>, 384f<sub>s</sub>, and their multiples (Note: f<sub>s</sub> refers to the ADC or DAC sample rate, whichever is faster)
- USB mode supports 12MHz or 24MHz master clocks. This mode is intended for use in systems with a USB interface, and eliminates the need for an external PLL to generate another clock frequency for the audio CODEC.

REGISTER ADDRESS	BIT	LABEL	DEFAULT	DESCRIPTION
R8 (08h) Clocking and Sample Rate Control	6	CLKDIV2	0	Master Clock Divide by 2 1 = MCLK is divided by 2 0 = MCLK is not divided
	5:1	SR [4:0]	00000	Sample Rate Control
	0	USB	0	Clocking Mode Select 1 = USB Mode 0 = 'Normal' Mode

Table 28 Clocking and Sample Rate Control



The clocking of the WM8972L is controlled using the CLKDIV2, USB, and SR control bits. Setting the CLKDIV2 bit divides MCLK by two internally. The USB bit selects between 'Normal' and USB mode. Each value of SR[4:0] selects one combination of MCLK division ratios and hence one combination of sample rates (see next page). Since all sample rates are generated by dividing MCLK, their accuracy depends on the accuracy of MCLK. If MCLK changes, the sample rates change proportionately.

Note that some sample rates (e.g. 44.1kHz in USB mode) are approximated, i.e. they differ from their target value by a very small amount. This is not audible, as the maximum deviation is only 0.27% (8.0214kHz instead of 8kHz in USB mode). By comparison, a half-tone step corresponds to a 5.9% change in pitch.

MCLK CLKDIV2=0	MCLK CLKDIV2=1	ADC SAMPLE RATE (ADCLRC)	DAC SAMPLE RATE (DACLRC)	USB	SR [4:0]	FILTER TYPE	BCLK (MS=1)
<b>'Normal' Clock Mode</b> (** indicates backward compatibility with WM8731)							
12.288 MHz	24.576 MHz	8 kHz (MCLK/1536)	8 kHz (MCLK/1536)	0	00110 *	1	MCLK/4
		8 kHz (MCLK/1536)	48 kHz (MCLK/256)	0	00100 *	1	MCLK/4
		12 kHz (MCLK/1024)	12 kHz (MCLK/1024)	0	01000	1	MCLK/4
		16 kHz (MCLK/768)	16 kHz (MCLK/768)	0	01010	1	MCLK/4
		24 kHz (MCLK/512)	24 kHz (MCLK/512)	0	11100	1	MCLK/4
		32 kHz (MCLK/384)	32 kHz (MCLK/384)	0	01100 *	1	MCLK/4
		48 kHz (MCLK/256)	8 kHz (MCLK/1536)	0	00010 *	1	MCLK/4
		48 kHz (MCLK/256)	48 kHz (MCLK/256)	0	00000 *	1	MCLK/4
11.2896MHz	22.5792MHz	8.0182 kHz (MCLK/1408)	8.0182 kHz (MCLK/1408)	0	10110 *	1	MCLK/4
		8.0182 kHz (MCLK/1408)	44.1 kHz (MCLK/256)	0	10100 *	1	MCLK/4
		11.025 kHz (MCLK/1024)	11.025 kHz (MCLK/1024)	0	11000	1	MCLK/4
		22.05 kHz (MCLK/512)	22.05 kHz (MCLK/512)	0	11010	1	MCLK/4
		44.1 kHz (MCLK/256)	8.0182 kHz (MCLK/1408)	0	10010 *	1	MCLK/4
		44.1 kHz (MCLK/256)	44.1 kHz (MCLK/256)	0	10000 *	1	MCLK/4
		88.2 kHz (MCLK/128)	88.2 kHz (MCLK/128)	0	11110 *	3	MCLK/2
		96 kHz (MCLK/128)	96 kHz (MCLK/128)	0	01110 *	3	MCLK/2
18.432MHz	36.864MHz	8 kHz (MCLK/2304)	8 kHz (MCLK/2304)	0	00111 *	1	MCLK/6
		8 kHz (MCLK/2304)	48 kHz (MCLK/384)	0	00101 *	1	MCLK/6
		12 kHz (MCLK/1536)	12 kHz (MCLK/1536)	0	01001	1	MCLK/6
		16kHz (MCLK/1152)	16 kHz (MCLK/1152)	0	01011	1	MCLK/6
		24kHz (MCLK/768)	24 kHz (MCLK/768)	0	11101	1	MCLK/6
		32 kHz (MCLK/576)	32 kHz (MCLK/576)	0	01101 *	1	MCLK/6
		48 kHz (MCLK/384)	48 kHz (MCLK/384)	0	00001 *	1	MCLK/6
		48 kHz (MCLK/384)	8 kHz (MCLK/2304)	0	00011 *	1	MCLK/6
16.9344MHz	33.8688MHz	96 kHz (MCLK/192)	96 kHz (MCLK/192)	0	01111 *	3	MCLK/3
		8.0182 kHz (MCLK/2112)	8.0182 kHz (MCLK/2112)	0	10111 *	1	MCLK/6
		8.0182 kHz (MCLK/2112)	44.1 kHz (MCLK/384)	0	10101 *	1	MCLK/6
		11.025 kHz (MCLK/1536)	11.025 kHz (MCLK/1536)	0	11001	1	MCLK/6
		22.05 kHz (MCLK/768)	22.05 kHz (MCLK/768)	0	11011	1	MCLK/6
		44.1 kHz (MCLK/384)	8.0182 kHz (MCLK/2112)	0	10011 *	1	MCLK/6
		44.1 kHz (MCLK/384)	44.1 kHz (MCLK/384)	0	10001 *	1	MCLK/6
		88.2 kHz (MCLK/192)	88.2 kHz (MCLK/192)	0	11111 *	3	MCLK/3
<b>USB Mode</b> (** indicates backward compatibility with WM8731)							
12.000MHz	24.000MHz	8 kHz (MCLK/1500)	8 kHz (MCLK/1500)	1	00110 *	0	MCLK
		8 kHz (MCLK/1500)	48 kHz (MCLK/250)	1	00100 *	0	MCLK
		8.0214 kHz (MCLK/1496)	8.0214kHz (MCLK/1496)	1	10111 *	1	MCLK
		8.0214 kHz (MCLK/1496)	44.118 kHz (MCLK/272)	1	10101 *	1	MCLK
		11.0259 kHz (MCLK/1088)	11.0259kHz (MCLK/1088)	1	11001	1	MCLK
		12 kHz (MCLK/1000)	12 kHz (MCLK/1000)	1	01000	0	MCLK
		16kHz (MCLK/750)	16kHz (MCLK/750)	1	01010	0	MCLK
		22.0588kHz (MCLK/544)	22.0588kHz (MCLK/544)	1	11011	1	MCLK
		24kHz (MCLK/500)	24kHz (MCLK/500)	1	11100	0	MCLK
		32 kHz (MCLK/375)	32 kHz (MCLK/375)	1	01100 *	0	MCLK
		44.118 kHz (MCLK/272)	8.0214kHz (MCLK/1496)	1	10011 *	1	MCLK
		44.118 kHz (MCLK/272)	44.118 kHz (MCLK/272)	1	10001 *	1	MCLK
		48 kHz (MCLK/250)	8 kHz (MCLK/1500)	1	00010 *	0	MCLK
		48 kHz (MCLK/250)	48 kHz (MCLK/250)	1	00000 *	0	MCLK
		88.235kHz (MCLK/136)	88.235kHz (MCLK/136)	1	11111 *	3	MCLK
		96 kHz (MCLK/125)	96 kHz (MCLK/125)	1	01110 *	2	MCLK

Table 29 Master Clock and Sample Rates

## CONTROL INTERFACE

### SELECTION OF CONTROL MODE

The WM8972L is controlled by writing to registers through a serial control interface. A control word consists of 16 bits. The first 7 bits (B15 to B9) are address bits that select which control register is accessed. The remaining 9 bits (B8 to B0) are data bits, corresponding to the 9 bits in each control register. The control interface can operate as either a 3-wire or 2-wire MPU interface. The MODE pin selects the interface format.

MODE	INTERFACE FORMAT
Low	2 wire
High	3 wire

Table 30 Control Interface Mode Selection

### 3-WIRE SERIAL CONTROL MODE

In 3-wire mode, every rising edge of SCLK clocks in one data bit from the SDIN pin. A rising edge on CSB latches in a complete control word consisting of the last 16 bits.

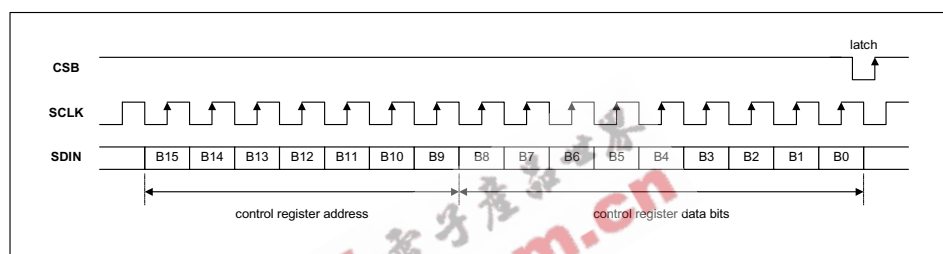

Figure 18 3-Wire Serial Control Interface

### 2-WIRE SERIAL CONTROL MODE

The WM8972L supports software control via a 2-wire serial bus. Many devices can be controlled by the same bus, and each device has a unique 7-bit address (this is not the same as the 7-bit address of each register in the WM8972L).

The WM8972L operates as a slave device only. The controller indicates the start of data transfer with a high to low transition on SDIN while SCLK remains high. This indicates that a device address and data will follow. All devices on the 2-wire bus respond to the start condition and shift in the next eight bits on SDIN (7-bit address + Read/Write bit, MSB first). If the device address received matches the address of the WM8972L and the R/W bit is '0', indicating a write, then the WM8972L responds by pulling SDIN low on the next clock pulse (ACK). If the address is not recognised or the R/W bit is '1', the WM8972L returns to the idle condition and wait for a new start condition and valid address.

Once the WM8972L has acknowledged a correct address, the controller sends the first byte of control data (B15 to B8, i.e. the WM8972L register address plus the first bit of register data). The WM8972L then acknowledges the first data byte by pulling SDIN low for one clock pulse. The controller then sends the second byte of control data (B7 to B0, i.e. the remaining 8 bits of register data), and the WM8972L acknowledges again by pulling SDIN low.

The transfer of data is complete when there is a low to high transition on SDIN while SCLK is high. After receiving a complete address and data sequence the WM8972L returns to the idle state and waits for another start condition. If a start or stop condition is detected out of sequence at any point during data transfer (i.e. SDIN changes while SCLK is high), the device jumps to the idle condition.

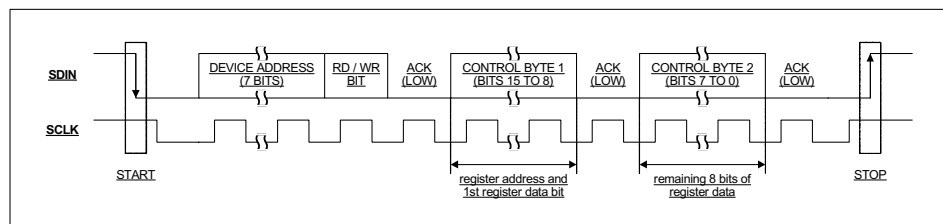

Figure 19 2-Wire Serial Control Interface

The WM8972L has two possible device addresses, which can be selected using the CSB pin.

CSB STATE	DEVICE ADDRESS
Low	0011010 (0 x 34h)
High	0011011 (0 x 36h)

**Table 31 2-Wire MPU Interface Address Selection**

## POWER SUPPLIES

The WM8972L can use up to four separate power supplies:

- AVDD / AGND: Analogue supply, powers all analogue functions except the headphone drivers. AVDD can range from 1.8V to 3.6V and has the most significant impact on overall power consumption (except for power consumed in the headphone). A large AVDD slightly improves audio quality.
- OPVDD / OPGND: Output supply, powers the output drivers. OPVDD can range from 1.8V to 3.6V. OPVDD is normally tied to AVDD, but it requires separate layout and decoupling capacitors to curb harmonic distortion. With a larger OPVDD, louder speaker outputs can be achieved with lower distortion. If OPVDD is lower than AVDD, the output signal may be clipped.
- DCVDD: Digital core supply, powers all digital functions except the audio and control interfaces. DCVDD can range from 1.42V to 3.6V, and has no effect on audio quality. The return path for DCVDD is DGND, which is shared with DBVDD.
- DBVDD: Digital buffer supply, powers the audio and control interface buffers. This makes it possible to run the digital core at very low voltages, saving power, while interfacing to other digital devices using a higher voltage. DBVDD draws much less power than DCVDD, and has no effect on audio quality. DBVDD can range from 1.8V to 3.6V. The return path for DBVDD is DGND, which is shared with DCVDD.

It is possible to use the same supply voltage on all four. However, digital and analogue supplies should be routed and decoupled separately to keep digital switching noise out of the analogue signal paths.

## POWER MANAGEMENT

The WM8972L has two control registers that allow users to select which functions are active. For minimum power consumption, unused functions should be disabled. To avoid any pop or click noise, it is important to enable or disable functions in the correct order (see Applications Information). VMIDSEL is the enable for the Vmid reference, which defaults to disabled and can be enabled as a 50kOhm potential divider or, for low power maintenance of Vref when all other blocks are disabled, as a 500kOhm potential divider.

REGISTER ADDRESS	BIT	LABEL	DEFAULT	DESCRIPTION
R25 (19h) Power Management (1)	8:7	VMIDSEL	00	Vmid divider enable and select 00 – Vmid disabled (for OFF mode) 01 – 50kOhm divider enabled (for playback/record) 10 – 500kOhm divider enabled (for low-power standby) 11 – 5kOhm divider enabled (for fast start-up)
	6	VREF	0	VREF (necessary for all other functions)
	5	AIN	0	Analogue in PGA
	3	ADC	0	ADC
	1	MICB	0	MICBIAS
R26 (1Ah) Power Management (2)	8	DAC	0	DAC
	4	OUT+	0	OUT+ Output Buffer*
	3	OUT-	0	OUT- Output Buffer*
	2	MONO	0	MONOOUT Output Buffer and Mono Mixer
	1	OUT2	0	OUT2 Output Buffer
<p><b>Note:</b> All control bits are 0=OFF, 1=ON * The plus mixer is enabled when OUT+=1. The minus mixer is enabled when OUT-=1.</p>				

**Table 32 Power Management**

### STOPPING THE MASTER CLOCK

In order to minimise power consumed in the digital core of the WM8972L, the master clock should be stopped in Standby and OFF modes. If this is cannot be done externally at the clock source, the DIGENB bit (R25, bit 0) can be set to stop the MCLK signal from propagating into the device core. In Standby mode with all supplies at 3.3V, setting DIGENB saves approximately 0.27mA on DCVDD and 0.2mA on DBVDD. However, since setting DIGENB has no effect on the power consumption of other system components external to the WM8972L, it is preferable to disable the master clock at its source wherever possible.

REGISTER ADDRESS	BIT	LABEL	DEFAULT	DESCRIPTION
R25 (19h) Additional Control (1)	1	DIGENB	0	Master clock disable 0: master clock enabled 1: master clock disabled

**Table 33 ADC and DAC Oversampling Rate Selection**

**NOTE:** Before DIGENB can be set, the control bits ADC, DAC must be set to zero and a waiting time of 1ms must be observed. Any failure to follow this procedure may prevent the DAC and ADC from re-starting correctly.

### SAVING POWER BY REDUCING OVERSAMPLING RATE

The default mode of operation of the ADC and DAC digital filters is in 128x oversampling mode. Under the control of ADCOSR and DACOSR the oversampling rate may be halved. This will result in a slight decrease in noise performance but will also reduce the power consumption of the device. In USB mode ADCOSR must be set to 0, i.e. 128x oversampling.

REGISTER ADDRESS	BIT	LABEL	DEFAULT	DESCRIPTION
R24 (18h) Additional Control (2)	1	ADCOSR	0	ADC oversample rate select 1 = 64x (lowest power) 0 = 128x (best SNR)
	0	DACOSR	0	DAC oversample rate select 1 = 64x (lowest power) 0 = 128x (best SNR)

**Table 34 ADC and DAC Oversampling Rate Selection**

ADCOSR set to '1', 64x oversample mode, is not supported in USB mode (USB = 1).

### SAVING POWER AT LOW SUPPLY VOLTAGES

The analogue supplies to the WM8972L can run from 1.8V to 3.6V. By default, all analogue circuitry on the device is optimized to run at 3.3V. This set-up is also good for all other supply voltages down to 1.8V. However, at lower voltages, it is possible to save power by reducing the internal bias currents used in the analogue circuitry. This is controlled as shown below.

REGISTER ADDRESS	BIT	LABEL	DEFAULT	DESCRIPTION
R23 (17h) Additional Control(1)	7:6	VSEL [1:0]	11	Analogue Bias optimization 00: Lowest bias current, optimized for AVDD=1.8V 01: Low bias current, optimized for AVDD=2.5V 1X: Default bias current, optimized for AVDD=3.3V

**Note:**

In USB mode ADCOSR must be set to 0, i.e. 128x oversampling.

**REGISTER MAP**

REGISTER	ADDRESS (Bit 15 – 9)	remarks	Bit[8]	Bit[7]	Bit[6]	Bit[5]	Bit[4]	Bit[3]	Bit[2]	Bit[1]	Bit[0]	default	page ref	
R0 (00h)	0000000	Input volume	IVU	INMUTE	IZC	INVOL					010010111	15		
R4 (04h)	0000100	Reserved	0	0	0	0	0	0	0	0	0	000000000	-	
R5 (05h)	0000101	ADC & DAC Control	ADCDIV2	DACDIV2	0	ADCPOL	HPOR	DACMU	DEEMPH[1:0]		ADCHPD	000001000	15,20,23	
R6 (06h)	0000110	Reserved	0	0	0	0	0	0	0	0	0	000000000	-	
R7 (07h)	0000111	Audio Interface	0	BCLKINV	MS	0	LRP	WL[1:0]		FORMAT[1:0]		000001010	31	
R8 (08h)	0001000	Sample rate	0	0	CLKDIV2	SR[4:0]				USB		000000000	32	
R9 (09h)	0001001	Reserved	0	0	0	0	0	0	0	0	0	000000000	-	
R10 (0Ah)	0001010	DAC volume	DVU	DACVOL[7:0]							011111111		21	
R12 (0Ch)	0001100	Bass control	0	BB	BC	0	0	BASS[3:0]			000001111		22	
R13 (0Dh)	0001101	Treble control	0	0	TC	0	0	TRBL[3:0]			000001111		22	
R15 (0Fh)	0001111	Reset	writing to this register resets all registers to their default state									not reset	-	
R17 (11h)	0010001	ALC1	ALCSEL	0	MAXGAIN[2:0]			ALCL[3:0]			001111011		19	
R18 (12h)	0010010	ALC2	0	ALCZC	0	0	0	HLD[3:0]			000000000		19	
R19 (13h)	0010011	ALC3	0	DCY[3:0]			ATK[3:0]			000110010		19		
R20 (14h)	0010100	Noise Gate	0	NGTH[4:0]				NGG[1:0]		NGAT		000000000		20
R21 (15h)	0010101	ADC volume	AVU	ADCVOL[7:0]							011000011		17	
R23 (17h)	0010111	Additional control(1)	TSDEN	VSEL[1:0]		DMONOMIX[1:0]		DATSEL[1:0]		DACINV	TOEN	011000000	14,15,23,27	
R24 (18h)	0011000	Additional control(2)	OUT2SW[1:0]		0	0	OUTINV	TRI	LRCM	ADDCOSR	DACOSR	000000000	27, 27,37	
R25 (19h)	0011001	Pwr Mgmt (1)	VMIDSEL[1:0]		VREF	AIN	0	ADC	0	MICB	DIGENB	000000000	36	
R26 (1Ah)	0011010	Pwr Mgmt (2)	DAC	0	0	0	OUT+	OUT-	MONO	OUT2	0	000000000	36	
R27 (1Bh)	0011011	Additional Control (3)	ADCLRM[1:0]		VROI	0	0	0	0	0	0	000000000	35	
R31 (1Fh)	0011111	ADC input mode	DS	MONOMIX[1:0]		0	DCM	0	0	0	0	000000000	14	
R32 (20h)	0100000	ADC signal path	0	INSEL[1:0]		MICBOOST[1:0]		0	0	0	0	000000000	14	
R34 (22h)	0100010	Plus out Mix (1)	D2+MO	+M2+MO	+M2+MOVOL[2:0]		0	+MIXSEL[2:0]			001010000		24	
R35 (23h)	0100011	Plus out Mix (2)	0	-M2-MO	-M2-MOVOL[2:0]		0	0	0	0	0	001010000	24	
R36 (24h)	0100100	Minus out Mix (1)	D2-MO	+M2-MO	+M2-MOVOL[2:0]		0	-MIXSEL[2:0]			001010000		25	
R37 (25h)	0100101	Minus out Mix (2)	0	-M2-MO	-M2-MOVOL[2:0]		0	0	0	0	0	001010000	25	
R38 (26h)	0100110	Mono out Mix (1)	D2MO	+M2MO	+M2MOVOL[2:0]		0	0	0	0	0	001010000	25	
R39 (27h)	0100111	Mono out Mix (2)	0	-M2MO	-M2MOVOL[2:0]		0	0	0	0	0	001010000	25	
R40 (28h)	0101000	OUT+ volume	+OVU	+OZC	+OUTVOL[6:0]						001111001		26	
R41 (29h)	0101001	OUT- volume	-OVU	-OZC	-OUTVOL[6:0]						001111001		26	
R42 (2Ah)	0101010	MONOOUT volume	0	MOZC	MOUTVOL[6:0]						001111001		26	

**Note:**

All unused register bits must be set to 0.

## DIGITAL FILTER CHARACTERISTICS

The ADC and DAC employ different digital filters. There are 4 types of digital filter, called Type 0, 1, 2 and 3. The performance of Types 0 and 1 is listed in the table below, the responses of all filters is shown in the proceeding pages.

PARAMETER	TEST CONDITIONS	MIN	TYP	MAX	UNIT
<b>ADC Filter Type 0 (USB Mode, 250fs operation)</b>					
Passband	+/- 0.05dB	0		0.416fs	
	-6dB		0.5fs		
Passband Ripple				+/- 0.05	dB
Stopband		0.584fs			
Stopband Attenuation	f > 0.584fs	-60			dB
<b>ADC Filter Type 1 (USB mode, 272fs or Normal mode operation)</b>					
Passband	+/- 0.05dB	0		0.4535fs	
	-6dB		0.5fs		
Passband Ripple				+/- 0.05	dB
Stopband		0.5465fs			
Stopband Attenuation	f > 0.5465fs	-60			dB
High Pass Filter Corner Frequency	-3dB		3.7		Hz
	-0.5dB		10.4		
	-0.1dB		21.6		
<b>DAC Filter Type 0 (USB mode, 250fs operation)</b>					
Passband	+/- 0.03dB	0		0.416fs	
	-6dB		0.5fs		
Passband Ripple				+/-0.03	dB
Stopband		0.584fs			
Stopband Attenuation	f > 0.584fs	-50			dB
<b>DAC Filter Type 1 (USB mode, 272fs or Normal mode operation)</b>					
Passband	+/- 0.03dB	0		0.4535fs	
	-6dB		0.5fs		
Passband Ripple				+/- 0.03	dB
Stopband		0.5465fs			
Stopband Attenuation	f > 0.5465fs	-50			dB

Table 35 Digital Filter Characteristics

## TERMINOLOGY

1. Stop Band Attenuation (dB) – the degree to which the frequency spectrum is attenuated (outside audio band)
2. Pass-band Ripple – any variation of the frequency response in the pass-band region

DAC FILTER RESPONSES

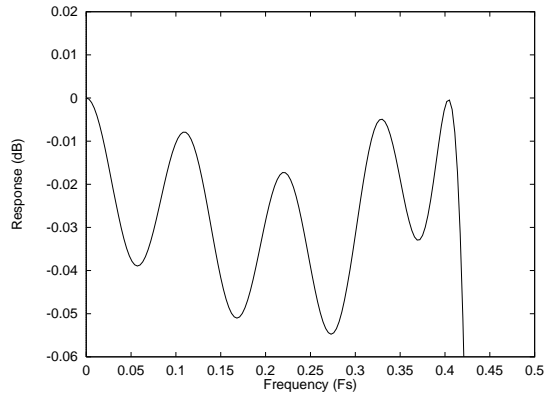
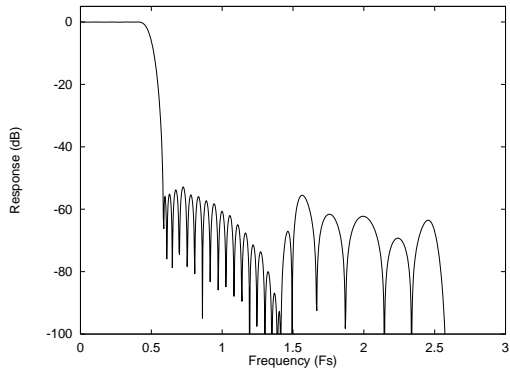

Figure 20 DAC Digital Filter Frequency Response – Type 0 Figure 21 DAC Digital Filter Ripple – Type 0

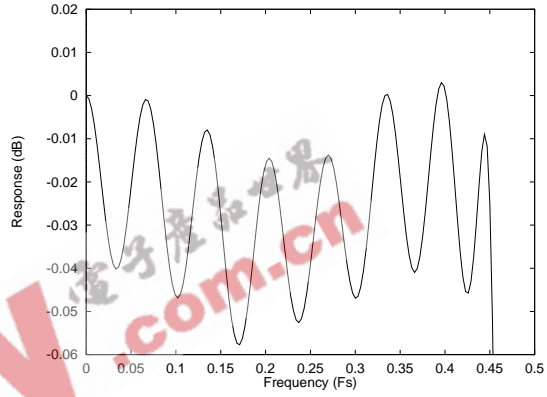
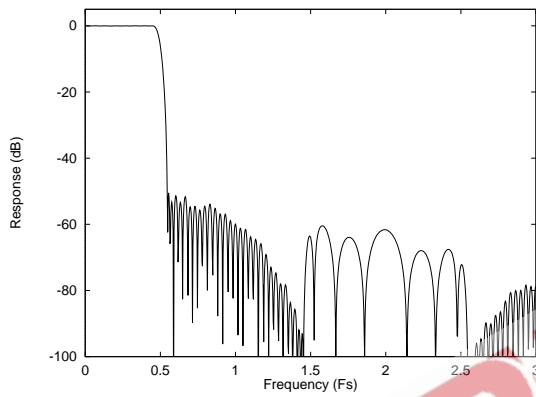

Figure 22 DAC Digital Filter Frequency Response – Type 1 Figure 23 DAC Digital Filter Ripple – Type 1

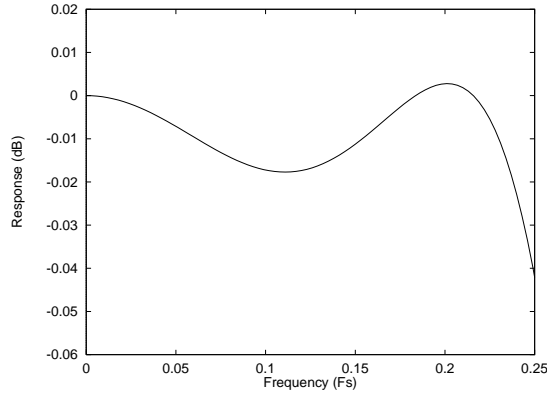
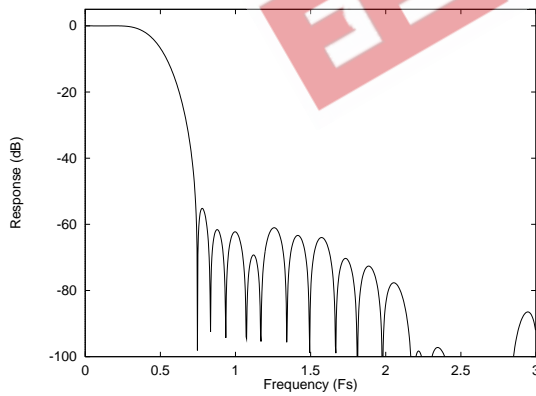

Figure 24 DAC Digital Filter Frequency Response – Type 2 Figure 25 DAC Digital Filter Ripple – Type 2



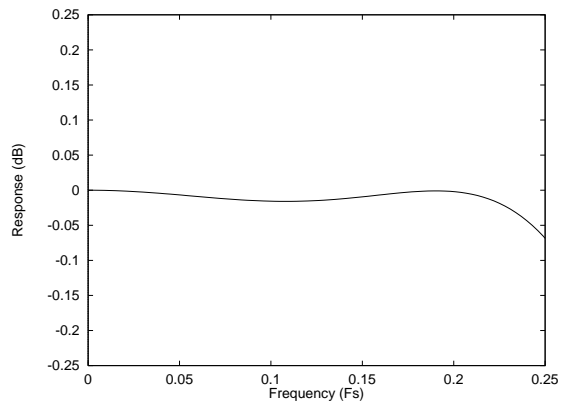
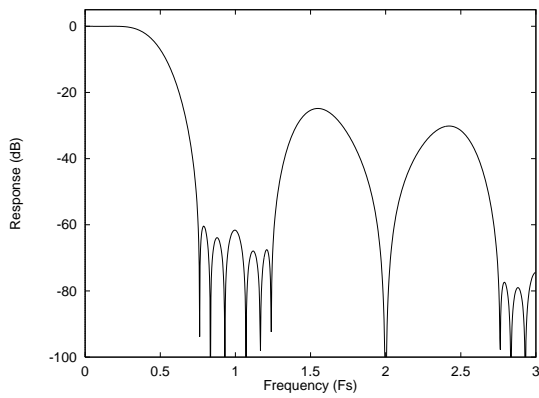

Figure 26 DAC Digital Filter Frequency Response – Type 3 Figure 27 DAC Digital Filter Ripple – Type 3

**ADC FILTER RESPONSES**

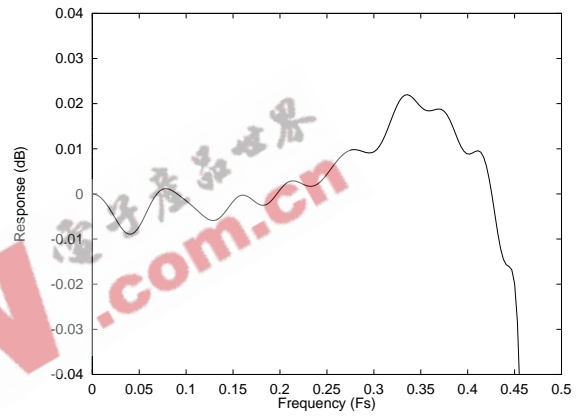
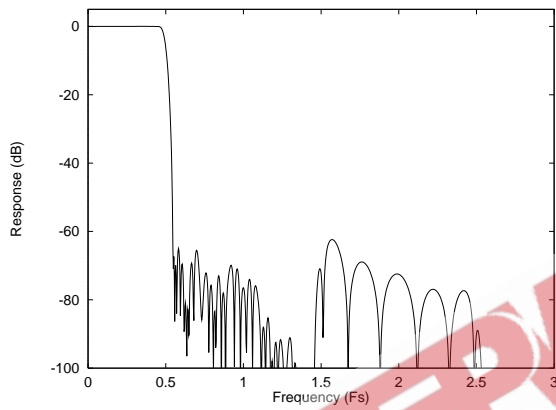

Figure 28 ADC Digital Filter Frequency Response – Type 0

Figure 29 ADC Digital Filter Ripple – Type 0

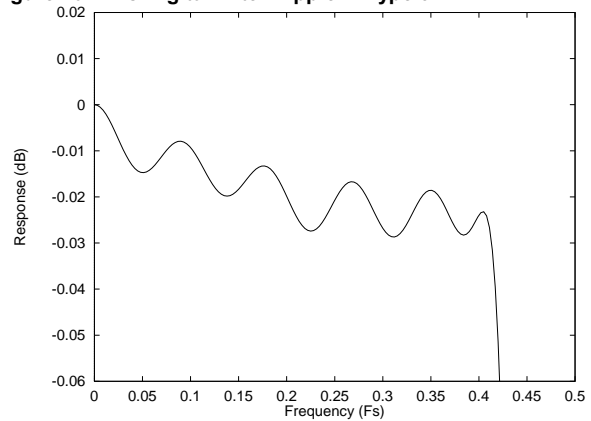
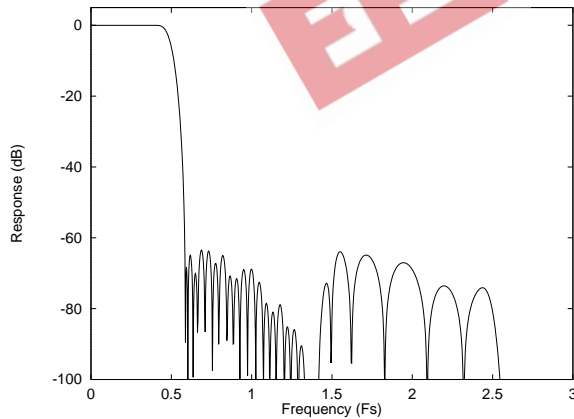

Figure 30 ADC Digital Filter Frequency Response – Type 1

Figure 31 ADC Digital Filter Ripple – Type 1

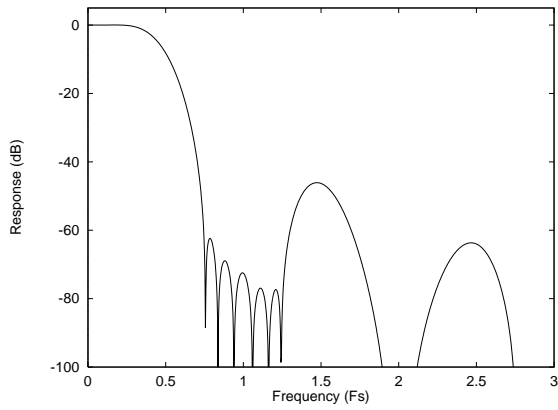

Figure 32 ADC Digital Filter Frequency Response – Type 2

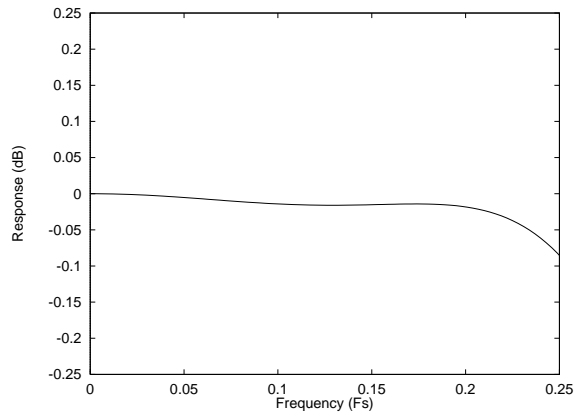

Figure 33 ADC Digital Filter Ripple – Type 2

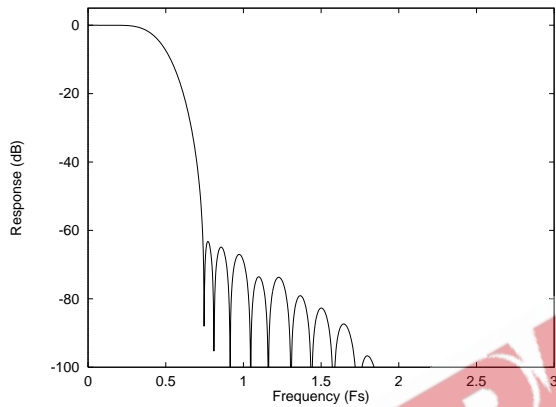

Figure 34 ADC Digital Filter Frequency Response – Type 2

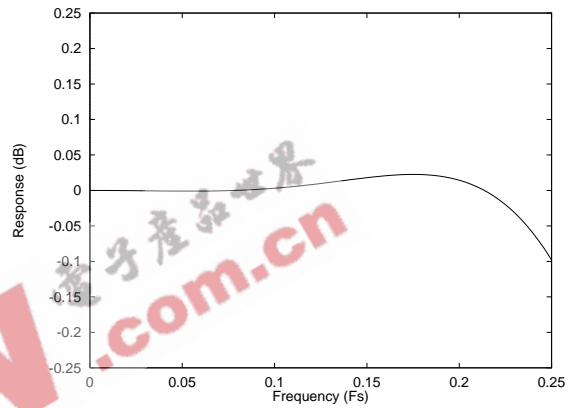

Figure 35 ADC Digital Filter Ripple – Type 3

**DE-EMPHASIS FILTER RESPONSES**

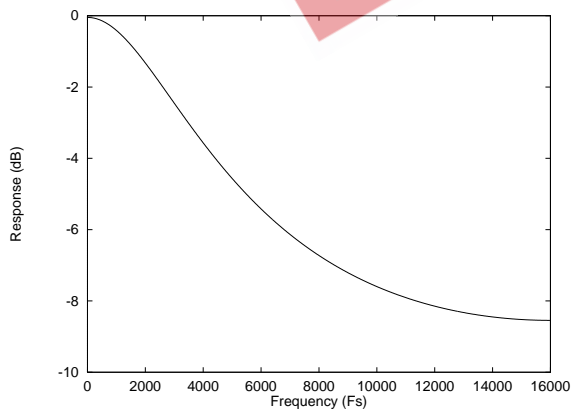

Figure 36 De-emphasis Frequency Response (32kHz)

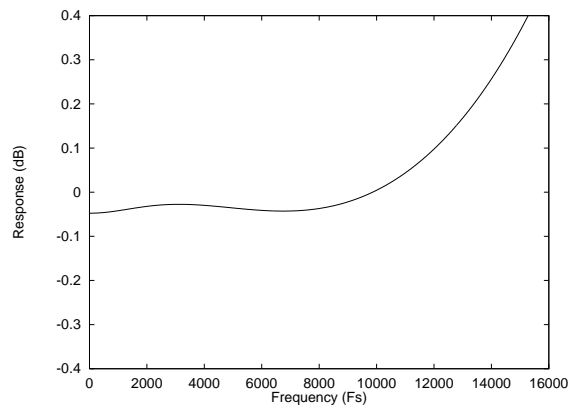

Figure 37 De-emphasis Error (32kHz)

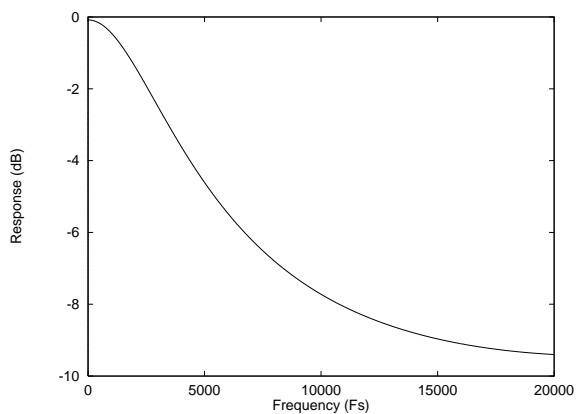

Figure 38 De-emphasis Frequency Response (44.1kHz)

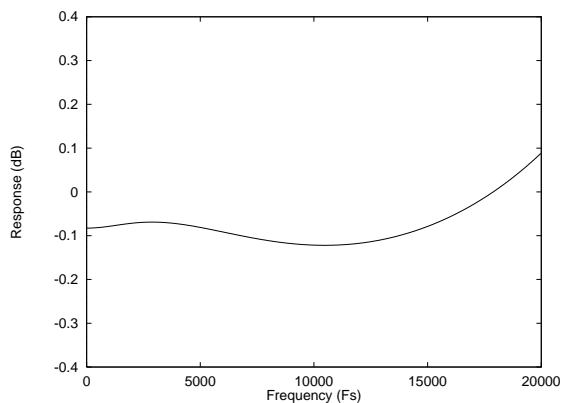

Figure 39 De-emphasis Error (44.1kHz)

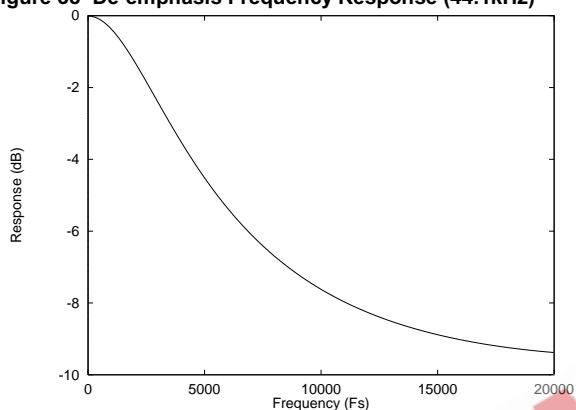

Figure 40 De-emphasis Frequency Response (48kHz)

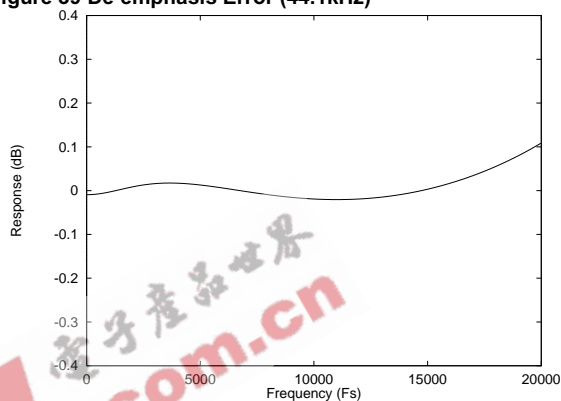

Figure 41 De-emphasis Error (48kHz)

### HIGHPASS FILTER

The WM8972L has a selectable digital highpass filter in the ADC filter path to remove DC offsets. The filter response is characterised by the following polynomial:

$$H(z) = \frac{1 - z^{-1}}{1 - 0.9995z^{-1}}$$

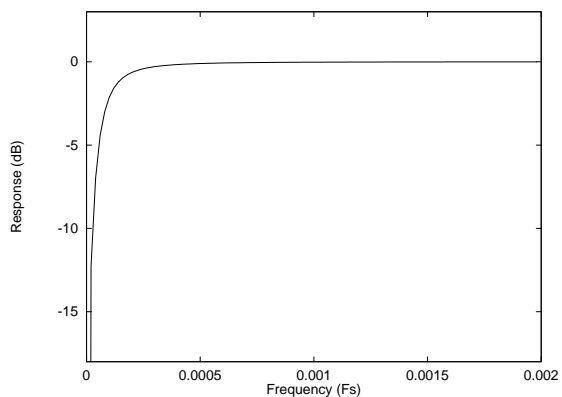

Figure 42 ADC Highpass Filter Response

APPLICATIONS INFORMATION

RECOMMENDED EXTERNAL COMPONENTS

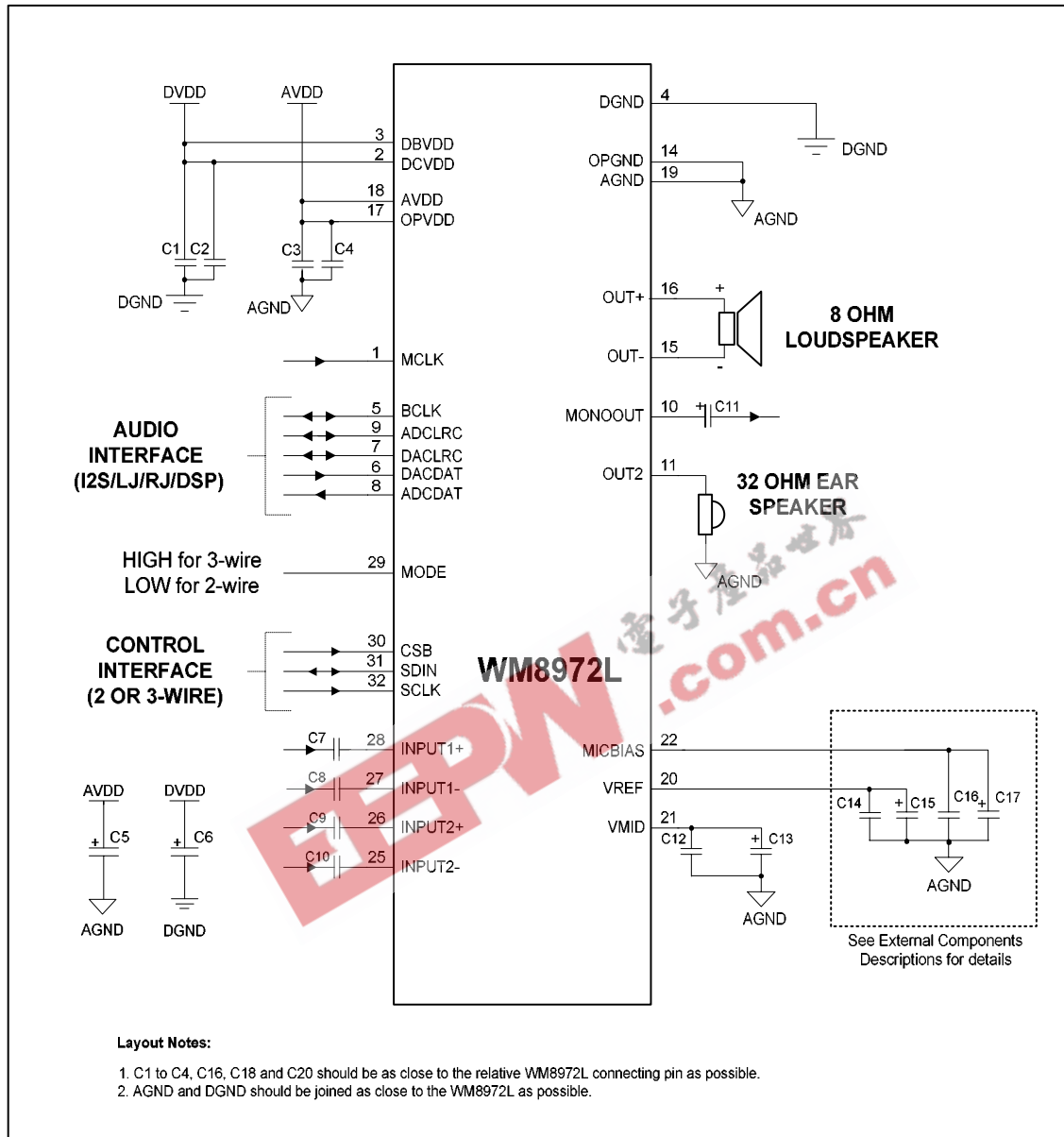

Figure 43 Recommended External Components Diagram

COMPONENT REFERENCE	SUGGESTED VALUE	DESCRIPTION
C1 – C4	100nF	De-coupling for DBVDD, DCVDD, AVDD, OPVDD
C5 – C6	10uF	Reservoir capacitor for DVDD, AVDD. Should the supplies use separate sources then additional capacitors will be required of each additional source.
C7 – C10	1uF	AC input coupling capacitors
C11	2.2uF	Output AC coupling capacitors to remove DC level from MONOOUT
C12	100nF	De-coupling for VMID.
C13	10uF	Reservoir capacitor for VMID
C14	100nF	De-coupling for VREF
C15	10uF	Reservoir capacitor for VREF
C16	100nF	De-coupling for MICBIAS – Not required if MICBIAS output is not used
C17	10uF	Reservoir capacitor for MICBIAS – Not required if MICBIAS output is not used

Table 36 External Components Descriptions

**Note:**

- For Capacitors C5, C6, C13, C15 and C17 it is recommended that very low ESR components are used.

**LINE INPUT CONFIGURATION**

When INPUT1+/INPUT1- or INPUT2+/INPUT2- are used as line inputs, the microphone boost and ALC functions should normally be disabled.

In order to avoid clipping, the user must ensure that the input signal does not exceed AVDD. This may require a potential divider circuit in some applications. It is also recommended to remove RF interference picked up on any cables using a simple first-order RC filter, as high-frequency components in the input signal may otherwise cause aliasing distortion in the audio band. AC signals with no DC bias should be fed to the WM8972L through a DC blocking capacitor, e.g. 1 $\mu$ F.

**MICROPHONE INPUT CONFIGURATION**

Figure 44 Recommended Circuit for Line Input

For interfacing to a microphone, the ALC function should be enabled and the microphone boost switched on. Microphones held close to a speaker's mouth would normally use the 13dB gain setting, while tabletop or room microphones would need a 29dB boost.

The recommended application circuit is shown above. R1 and R2 form part of the biasing network (refer to Microphone Bias section). R1 connected to MICBIAS is necessary only for electret type microphones that require a voltage bias. R2 should always be present to prevent the microphone input from charging to a high voltage which may damage the microphone on connection. R1 and R2 should be large so as not to attenuate the signal from the microphone, which can have source impedance greater than 2kOhm. C1 together with the source impedance of the microphone and the WM8972L input impedance forms an RF filter. C2 is a DC blocking capacitor to allow the microphone to be biased at a different DC voltage to the MICIN signal.

## MINIMISING POP NOISE AT THE ANALOGUE OUTPUTS

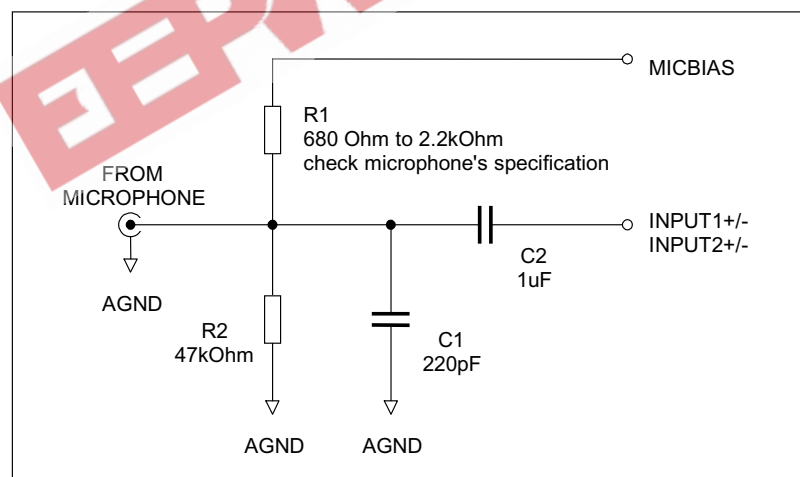
To minimise any pop or click noise when the system is powered up or down, the following procedures are recommended.

### POWER UP

- Switch on power supplies. By default the WM8972L is in Standby Mode, the DAC is digitally muted and the Audio Interface, Line outputs and Headphone outputs are all OFF (DACMU = 1 Power Management registers 1 and 2 are all zeros).
- Enable Vmid and VREF, then wait for time TBD
- Enable DAC as required
- Enable line and / or headphone output buffers as required.
- Set DACMU = 0 to soft-un-mute the audio DAC.

### POWER DOWN

- Set DACMU = 1 to soft-mute the audio DAC.
- Disable all output buffers, then wait for time TBD.
- Switch off the power supplies.

## POWER MANAGEMENT EXAMPLES

OPERATION MODE	POWER MANAGEMENT (1)				POWER MANAGEMENT (2)			
	VREF	AIN	ADC		DAC	Output Buffers		
				MBI		O2+	O2-	MO
Line-in Record	1	1	1	0	0	0	0	0
Mono Microphone Record	1	1	1	1	0	0	0	0
Microphone to mono out	1	1	0	1	0	0	0	1
Speaker Phone Call [OUTINV = 1]	1	1	0	1	0	1	1	1
Record Phone Call [L channel = mic with boost, R channel = RX, enable mono mix]	1	1	1	1	0	0	0	1

Table 37 Register Settings for Power Management

**PACKAGE DIMENSIONS**

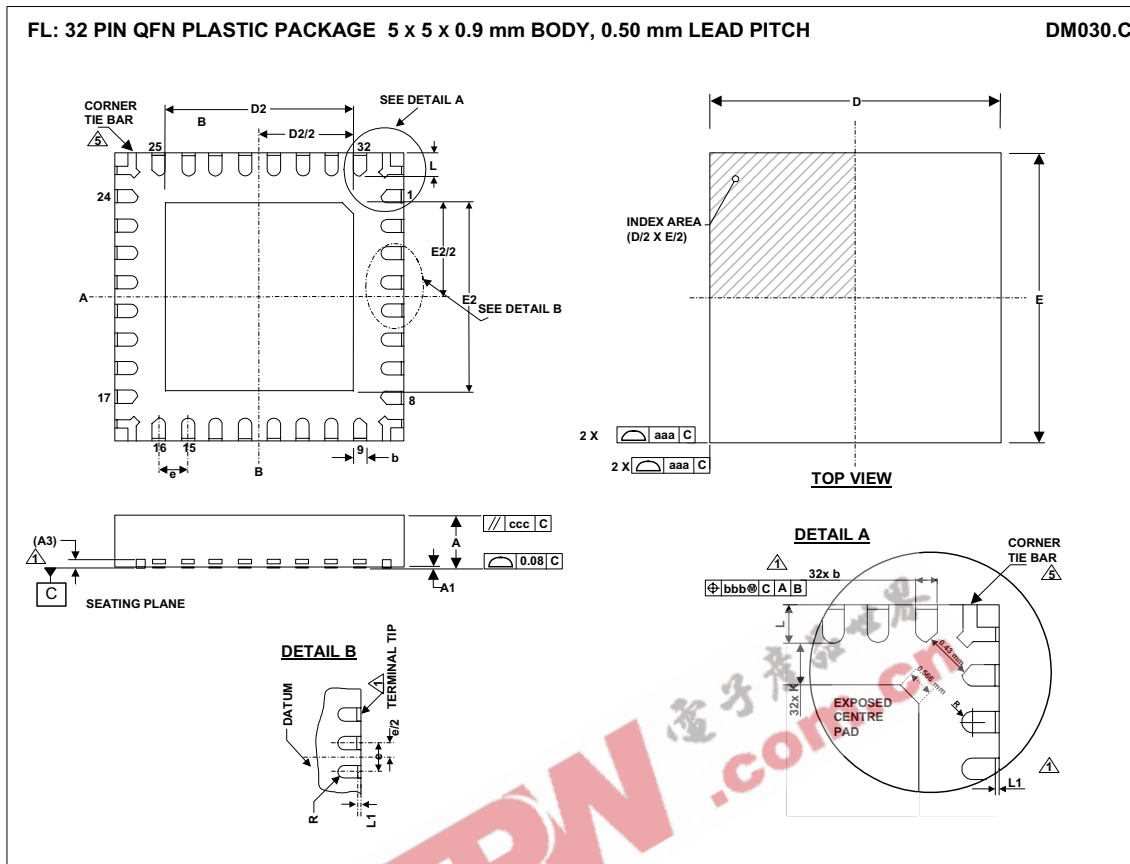

Symbols	Dimensions (mm)			NOTE
	MIN	NOM	MAX	
A	0.85	0.90	1.00	
A1	0	0.02	0.05	
A3		0.2 REF		
b	0.18	0.23	0.30	1
D	4.90	5.00	5.10	
D2	3.2	3.3	3.4	2
E	4.90	5.00	5.10	
E2	3.2	3.3	3.4	2
e		0.5 BSC		
L	0.35	0.4	0.45	
L1			0.1	1
R	b(min)/2			
K	0.20			
<b>Tolerances of Form and Position</b>				
aaa		0.15		
bbb		0.10		
ccc		0.10		
REF:	JEDEC, MO-220, VARIATION VKKD-2			

- NOTES:
- DIMENSION b APPLIED TO METALLIZED TERMINAL AND IS MEASURED BETWEEN 0.25 mm AND 0.30 mm FROM TERMINAL TIP. DIMENSION L1 REPRESENTS TERMINAL PULL BACK FROM PACKAGE SIDE WALL. MAXIMUM OF 0.1mm IS ACCEPTABLE. WHERE TERMINAL PULL BACK EXISTS, ONLY UPPER HALF OF LEAD IS VISIBLE ON PACKAGE SIDE WALL DUE TO HALF ETCHING OF LEADFRAME.
  - FALLS WITHIN JEDEC, MO-220 WITH THE EXCEPTION OF D2, E2:
  - D2, E2: LARGER PAD SIZE CHOSEN WHICH IS JUST OUTSIDE JEDEC SPECIFICATION
  - ALL DIMENSIONS ARE IN MILLIMETRES
  - THIS DRAWING IS SUBJECT TO CHANGE WITHOUT NOTICE.
  - SHAPE AND SIZE OF CORNER TIE BAR MAY VARY WITH PACKAGE TERMINAL COUNT. CORNER TIE BAR IS CONNECTED TO EXPOSED PAD INTERNALLY

## IMPORTANT NOTICE

Wolfson Microelectronics plc (WM) reserve the right to make changes to their products or to discontinue any product or service without notice, and advise customers to obtain the latest version of relevant information to verify, before placing orders, that information being relied on is current. All products are sold subject to the WM terms and conditions of sale supplied at the time of order acknowledgement, including those pertaining to warranty, patent infringement, and limitation of liability.

WM warrants performance of its products to the specifications applicable at the time of sale in accordance with WM's standard warranty. Testing and other quality control techniques are utilised to the extent WM deems necessary to support this warranty. Specific testing of all parameters of each device is not necessarily performed, except those mandated by government requirements.

In order to minimise risks associated with customer applications, adequate design and operating safeguards must be used by the customer to minimise inherent or procedural hazards. Wolfson products are not authorised for use as critical components in life support devices or systems without the express written approval of an officer of the company. Life support devices or systems are devices or systems that are intended for surgical implant into the body, or support or sustain life, and whose failure to perform when properly used in accordance with instructions for use provided, can be reasonably expected to result in a significant injury to the user. A critical component is any component of a life support device or system whose failure to perform can be reasonably expected to cause the failure of the life support device or system, or to affect its safety or effectiveness.

WM assumes no liability for applications assistance or customer product design. WM does not warrant or represent that any license, either express or implied, is granted under any patent right, copyright, mask work right, or other intellectual property right of WM covering or relating to any combination, machine, or process in which such products or services might be or are used. WM's publication of information regarding any third party's products or services does not constitute WM's approval, license, warranty or endorsement thereof.

Reproduction of information from the WM web site or datasheets is permissible only if reproduction is without alteration and is accompanied by all associated warranties, conditions, limitations and notices. Representation or reproduction of this information with alteration voids all warranties provided for an associated WM product or service, is an unfair and deceptive business practice, and WM is not responsible nor liable for any such use.

Resale of WM's products or services with statements different from or beyond the parameters stated by WM for that product or service voids all express and any implied warranties for the associated WM product or service, is an unfair and deceptive business practice, and WM is not responsible nor liable for any such use.

## ADDRESS:

Wolfson Microelectronics plc  
Westfield House  
26 Westfield Road  
Edinburgh  
EH11 2QB  
United Kingdom

Tel :: +44 (0)131 272 7000  
Fax :: +44 (0)131 272 7001  
Email :: [sales@wolfsonmicro.com](mailto:sales@wolfsonmicro.com)



**REVISION HISTORY**

DATE	RELEASE	DESCRIPTION OF CHANGES	PAGES
May 2003	Rev 1.0	Created	
16 Sept 03	Rev 2.0	Re-created with differential inputs	
22 Sept 03	Rev 2.1	WM8972LSEFL changed to WM8972LGEFL, /V added to order code and MSL data changed to MSL3	3
		Electrical Characteristics, Input Resistance, DM Measurement added	6
		Noise Gate Control note added	21
		Audio Interface Diagrams updated,	30-31
		Recommended External Components, words 16 or 32 ohm headphones removed)	45
		Power Management Examples updated	47
		Package Drawing updated	48
09 Jun 04	Rev2.2	Order Codes – Peak Soldering Temp added, /V removed and MSL changed to MSL1	3
		Absolute Maximum Ratings – body temp removed	5
		Speaker Output THD versus Power removed	8
		Package drawing changed	48
		Important notice – address details updated	49

EEPW 电子产品世界  
.com.cn