

PRELIMINARY SPEC

Part Number: WP7677C2ZGC



Technical Data



ATTENTION
OBSERVE PRECAUTIONS
FOR HANDLING
ELECTROSTATIC
DISCHARGE
SENSITIVE
DEVICES

Description

Static electricity and surge damage the LEDs. It is recommended to use a wrist band or anti-electrostatic glove when handling the LEDs.

All devices, equipment and machinery must be electrically grounded.

Features:

- * High Luminance output
- * Design for High Current Operation.
- * Uniform Color.
- * Low Power Consumption.
- * Low Thermal Resistance.
- * Low Profile.
- * Packaged in tubes for use with automatic insertion equipment.
- * RoHs Compliant.

Benefits:

- *Outstanding Material Efficiency.
- *Electricity savings.
- *Maintenance savings.
- *Reliable and Rugged.

Typical Applications:

- *Automotive Exterior Lighting.
- *Electronic Signs and Signals.
- *Specialty Lighting.



Selection Guide

Part No.	LED COLOR	Iv(cd)[1] @30mA		Viewing Angle[2]
		Min.	Typ.	2θ1/2 Typ.
WP7677C2ZGC	Green (AlInGaN)	3.8	9	30°

Notes:

1.Luminous intensity is measured with an integrating sphere after the device has stabilized; Luminous Intensity / luminous flux: +/-15%.
2.θ1/2 is the angle from optical centerline where the luminous intensity is 1/2 the optical centerline value.

Optical Characteristics at TA=25°C If=30mA Rθj-a=200°C/W

DEVICE TYPE	PEAK WAVELENGTH λPEAK (nm) TYP.	DOMINANT[1] WAVELENGTH λDOM (nm) TYP.	SPECTRAL LINE WAVELENGTH Δλ1/2(nm) TYP.
ZG	515	525	30

Note:

1.The dominant wavelength is derived from the CIE Chromaticity Diagram and represents the perceived color of the device; Wavelength: +/-1nm.

Electrical Characteristics at TA=25°C

DEVICE TYPE	FORWARD VOLTAGE [1] Vf (VOLTS) @ If=30mA		REVERSE CURRENT Ir (uA) @ VR=5V	CAPACITANCE C (pF) @ Vf=0V F=1MHZ	THERMAL RESISTANCE Rθj -pin °C/W
	TYP.	MAX.	MAX.	TYP.	TYP.
ZG	3.5	4.5	10	45	150

Note:

1. Forward Voltage: +/-0.1V.

Figures

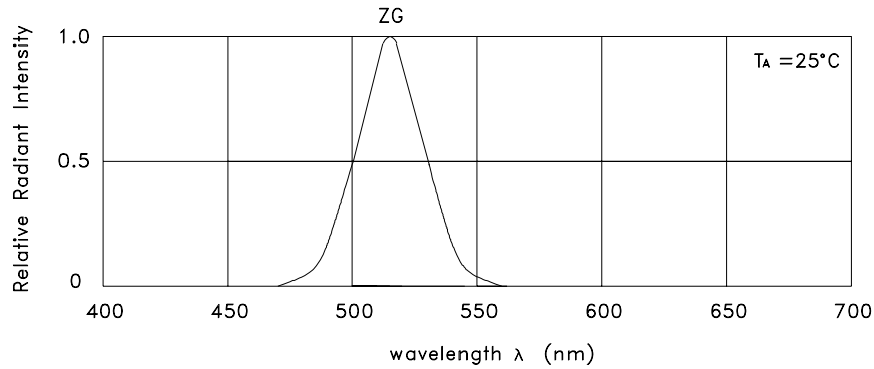

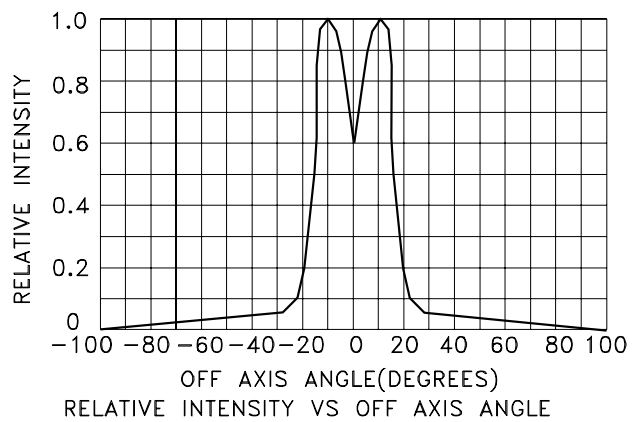
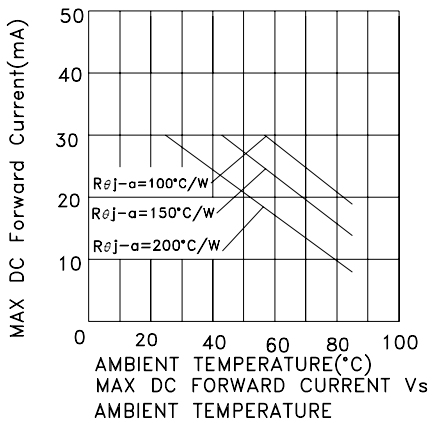
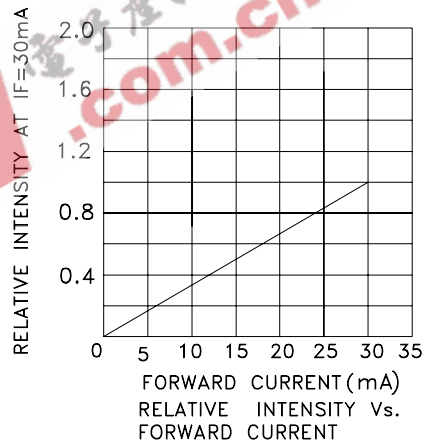
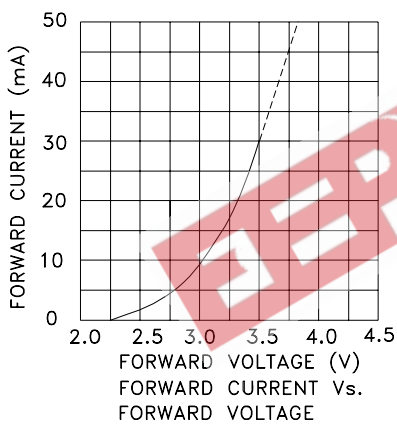

RELATIVE INTENSITY Vs. WAVELENGTH

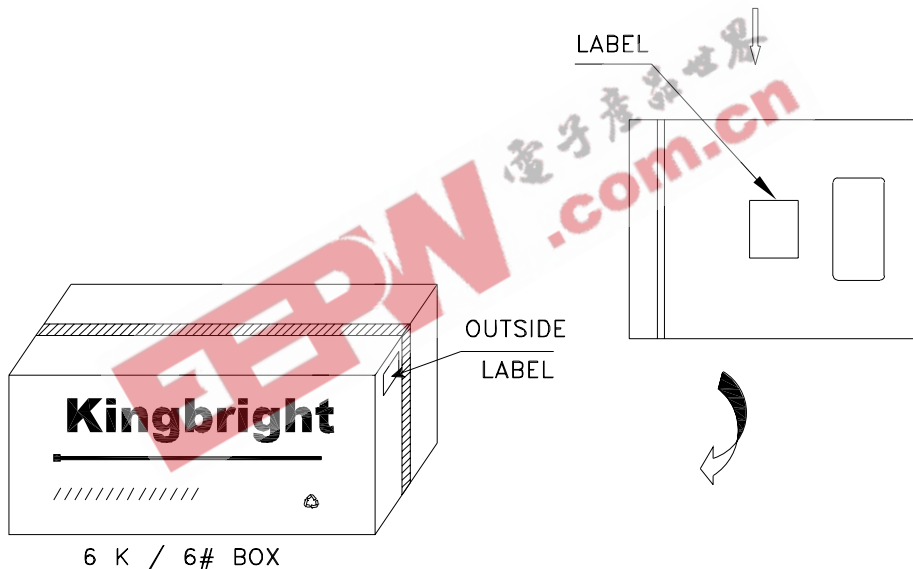
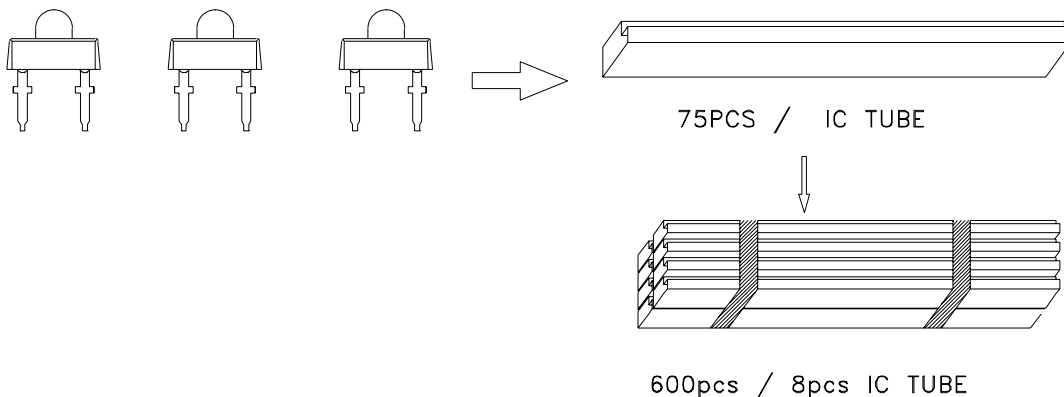

PACKING & LABEL SPECIFICATIONS

WP7677C2ZGC



Kingbright				
Q.C.	<table border="1"> <tr> <td>QC</td> </tr> <tr> <td>XX XX XX</td> </tr> <tr> <td>PASSED</td> </tr> </table>	QC	XX XX XX	PASSED
QC				
XX XX XX				
PASSED				
TYPE NO : WP7677C2xxx				
QUANTITY : 600 pcs				
S/N : XX	CODE: XX			
LOT NO :  <small>XXXXXXXXXXXX</small>				
MADE IN CHINA	RoHS Compliant			