

WPN20R

20 Watt Regulated DC/DC Converter



- Operating Temperature Range: -40°C to +100°C
- Industry Standard Pinout
- Input and Output Filtering
- Low Profile Shell
- Single and Dual Outputs
- High Efficiency
- Remote On/Off Function
- Output Trim Function
- Zero Load Operation
- EN 60950, UL1950, C-UL, VDE Agency Approvals



The WPN20R series is a family of high performance DC/DC converters available in three input voltage ranges of 9-18V, 18-36V and 33-75V. The unit is housed in a space saving aluminum shell and combines low cost with high performance across all line and load conditions. The 300KHz switching frequency and forward converter topology provide excellent performance

across all line and load conditions in a space saving package. Other features include: full regulation down to zero load, under voltage lock-out, internal temperature shutdown, soft start, remote on/off and over current protection.

An output trim feature is provided, allowing the user to compensate for long line lengths. The WPN20R Series is

assembled using a fully automated process incorporating 100% surface mounted components for increased reliability.

Applications include: Telecommunications, Battery Powered Systems, Process Control Equipment, Transportation Equipment and Distributed Power Systems.

PRODUCT SELECTION CHART

Specifications are at $T_A = +25^\circ\text{C}$ nominal input voltage, rated output current unless otherwise specified.

MODEL*	NOMINAL INPUT VOLTAGE (VDC)	RATED OUTPUT VOLTAGE (VDC)	OUTPUT CURRENT (A)		INPUT CURRENT NOM LOAD	EFFICIENCY (%)
			MIN LOAD	NOM LOAD		
WPN20R12S03	12	3.3	0.0	6.00	2.00	82
WPN20R12S05	12	5.0	0.0	4.00	2.00	84
WPN20R12S12	12	12.0	0.0	1.66	2.00	86
WPN20R12S15	12	15.0	0.0	1.33	2.00	86
WPN20R12D05	12	±5.0	0.0	±2.00	2.00	84
WPN20R12D12	12	±12.0	0.0	±0.83	2.00	86
WPN20R12D15	12	±15.0	0.0	±0.67	2.00	86
WPN20R24S03	24	3.3	0.0	6.00	1.00	83
WPN20R24S05	24	5.0	0.0	4.00	1.00	84
WPN20R24S12	24	12.0	0.0	1.66	1.00	87
WPN20R24S15	24	15.0	0.0	1.33	1.00	87
WPN20R24D05	24	±5.0	0.0	±2.00	1.00	85
WPN20R24D12	24	±12.0	0.0	±0.83	1.00	87
WPN20R24D15	24	±15.0	0.0	±0.67	1.00	87
WPN20R48S03	48	3.3	0.0	6.00	0.50	83
WPN20R48S05	48	5.0	0.0	4.00	0.50	85
WPN20R48S12	48	12.0	0.0	1.66	0.50	88
WPN20R48S15	48	15.0	0.0	1.33	0.50	86
WPN20R48D05	48	±5.0	0.0	±2.00	0.50	85
WPN20R48D12	48	±12.0	0.0	±0.83	0.50	87
WPN20R48D15	48	±15.0	0.0	±0.67	0.50	87

NOTE: Other input to output voltages may be available. Please consult factory.

SPECIFICATIONS, ALL MODELS

Specifications are at $T_A = +25^\circ\text{C}$ nominal input voltage, rated output current unless otherwise specified.

	PARAMETER	CONDITIONS	MIN	TYP	MAX	UNITS
INPUT	INPUT					
	Voltage Range		9	12	18	V_{DC}
			18	24	36	V_{DC}
OUTPUT			33	48	75	V_{DC}
	Reflected Ripple Current	All Input Ranges			50	mApk-pk
	INPUT CONTROL					
	Temperature Shutdown	Case	105		115	$^\circ\text{C}$
	Temperature Hysteresis			10		$^\circ\text{C}$
	Quiescent Standby Current	Current Into + V_{IN}		8	10	mA
	Undervoltage Control	See Attached Plots				
	OUTPUT					
	ISOLATION					
	Rated Voltage		1500			V_{DC}
	Test Voltage	60Hz, 10 Seconds	1500			V_{DC}
	Resistance			10		GW
	Capacitance			400		pF
	Leakage Current			30		mArms
	Rated Power				20	W
Voltage Setpoint Accuracy				± 1.5	%	
Temperature Coefficient				± 0.005	$\%/^\circ\text{C}$	
GENERAL	Line Regulation					
	Singles	High Line to Low Line			± 0.1	%
	Duals	High Line to Low Line			± 0.5	%
	Load Regulation					
	Singles	Mn Load to Nom. Load			± 0.5	%
	Duals	Mn Load to Nom. Load			± 2.0	%
	Ripple & Noise					
	Single Outputs	BW = 5Hz to 20MHz		60	100	mVp-p
	Dual Outputs	BW = 5Hz to 20MHz		50	100	mVp-p
	Output Adjust Range	See Attached Plots				
	Short Circuit and Overcurrent Protection	Continuous				
	Max Capacitive Load			550		mF/A
	GENERAL					
	Switching Frequency			300		KHz
	MTTF per ML-HDBK-217	Circuit Stress Method				
Ground Benign	$T_A = +25^\circ$ Unmodified Database		1,400,000		Hr	
Package Weight			32		g	
TEMPERATURE						
Specification	Case	-40		+ 85	$^\circ\text{C}$	
Operation	Case	-40		+ 85	$^\circ\text{C}$	
Storage		-55		+125	$^\circ\text{C}$	

REMOTE ON/OFF CONTROL

Logic Compatibility Open Collector TTL
 EC On Open Circuit
 EC Off < 0.7V
 Shutdown Idle Current 8mA

ORDERING INFORMATION

Device Family WPN20R XXYZZ
 20W Regulated DC/DC Unit

Model Number _____
 xx = Input Range, e.g. 48V
 y = Number of Outputs (S=single; D=dual)
 zz = Output Voltage, e.g. '05' for 5V

MECHANICAL

PIN SIDE DOWN

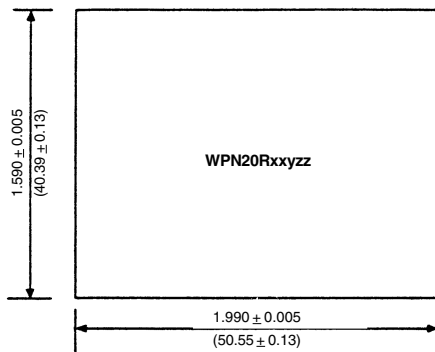

SIDE VIEW

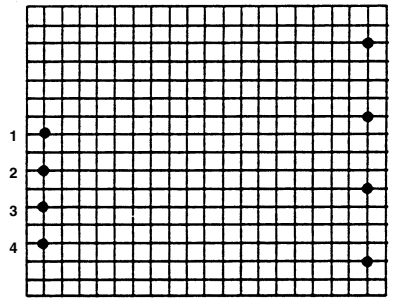
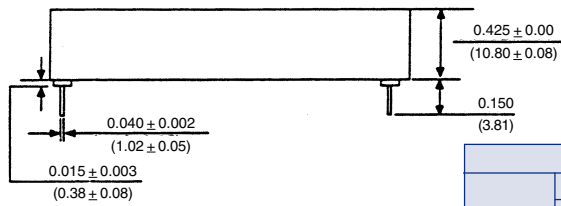

PIN SIDE UP

PIN CONNECTIONS

Number	Pin Function	
	Singles	Duals
1	+VIN	+VIN
2	-VIN	-VIN
3	NO PIN	NO PIN
4	Remote On/Off	Remote On/Off
5	NO PIN	+VOUT
6	+VOUT	COMMON
7	-VOUT	-VOUT
8	TRIM	TRIM

NOTES:

All dimensions are in inches (millimeters).
 GRID: 0.100 inches (2.54 millimeters)
 Pin Placement: Tolerance: ±0.015
 Marked with: specific model ordered, date code, job code.
MATERIAL: Units are encapsulated in a low thermal resistance molding compound which has excellent chemical resistance, wide operating temperature range, and good electrical properties under high humidity environments. The encapsulant and outer shell of the unit have UL94V-0 ratings. Lead material is brass with a solder plated surface to allow ease of solderability.

SIMPLIFIED CIRCUIT DIAGRAM

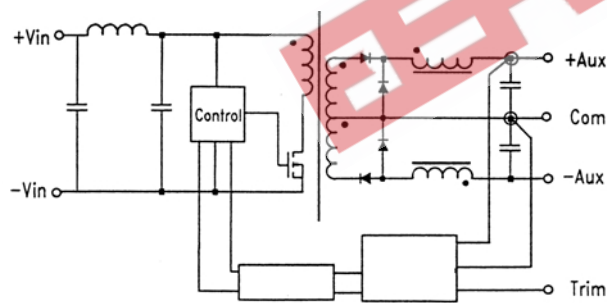

THERMAL DERATING CURVE

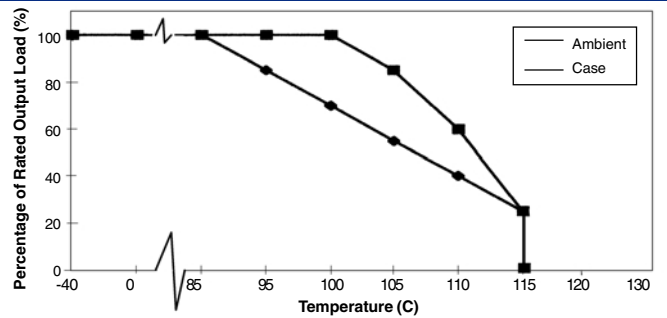

HYSTERESIS GRAPH

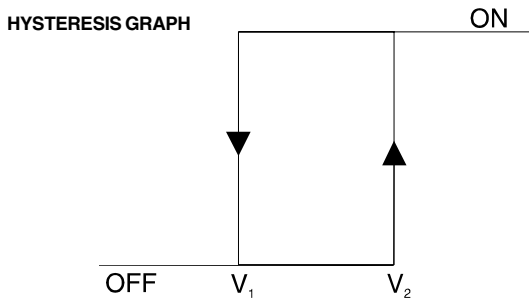

Undervoltage Lockout Threshold Voltages

Nominal Input Voltage Range	Shutdown Low Voltage (V1) OFF	Shutdown High Voltage (V2) ON
12	7	8.8
24	15.5	17
48	30	33

Specifications typical at TA=25°C, rated output current.

PERFORMANCE GRAPHS

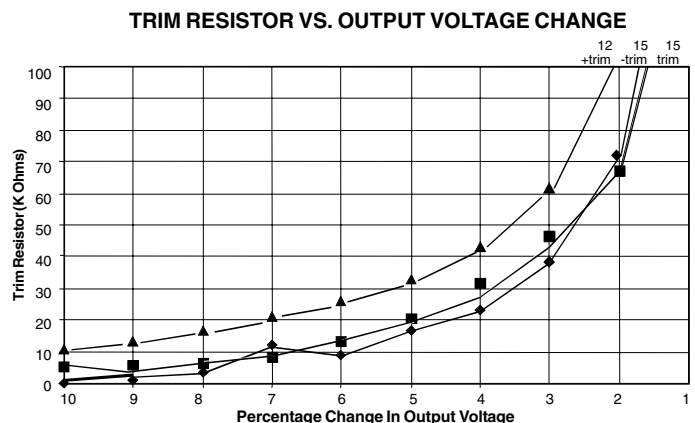
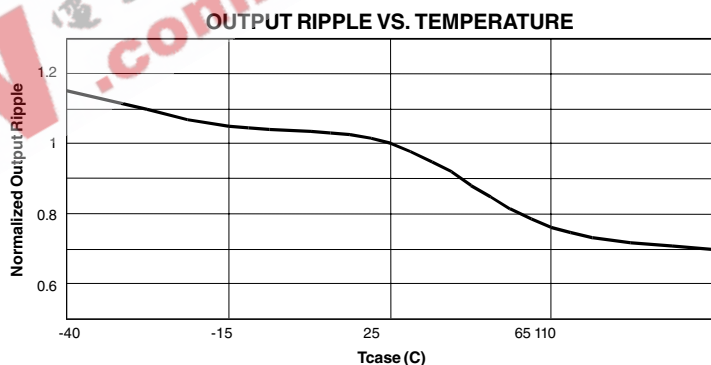
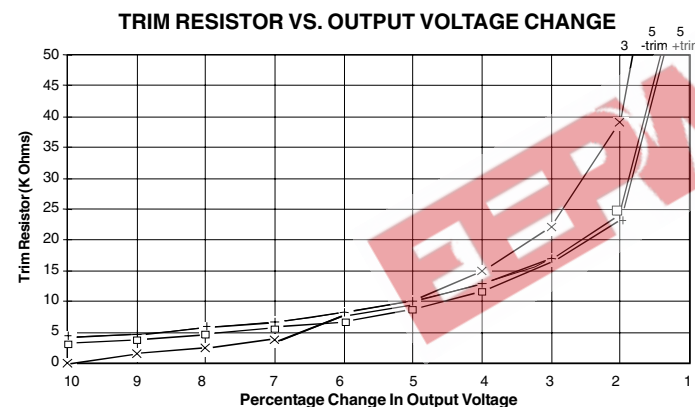
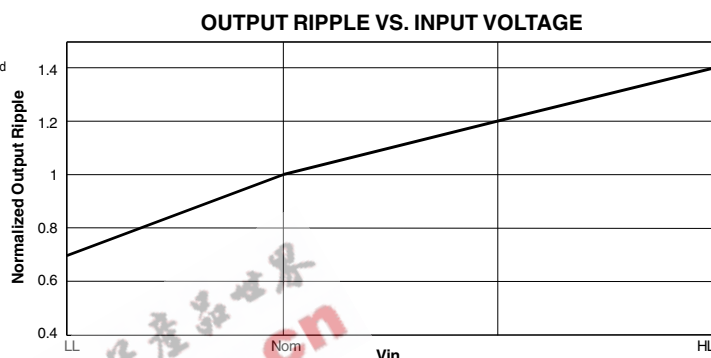
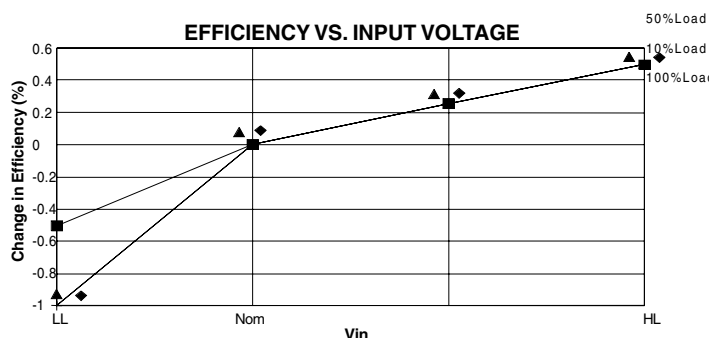
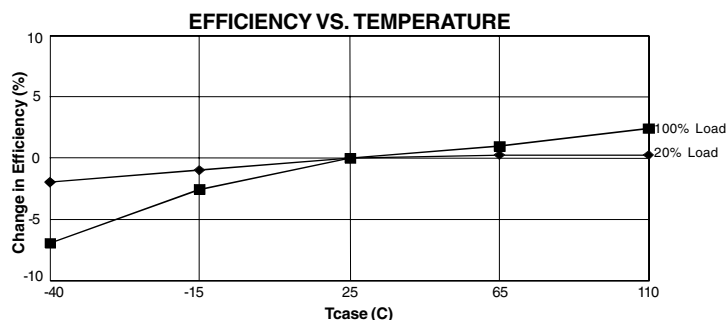
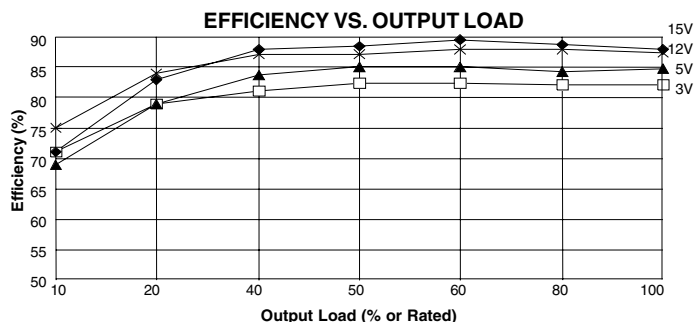

Power Electronics Division, United States
 3400 E Britannia Drive, Tucson, Arizona 85706
 Tel: 800.547.2537 Fax: 520.770.9369

C&D Technologies, (NCL)
 Milton Keynes MK14 5BU UK
 Tel: +44 (0)1908 615232 Fax: +44 (0)1908 617545

Any data, prices, descriptions or specifications presented herein are subject to revision by C&D Technologies, Inc. without notice. While such information is believed to be accurate as indicated herein, C&D Technologies, Inc. makes no warranty and hereby disclaims all warranties, express or implied, with regard to the accuracy or completeness of such information. Further, because the product(s) featured herein may be used under conditions beyond its control, C&D Technologies, Inc. hereby disclaims all warranties, either express or implied, concerning the fitness or suitability of such product(s) for any particular use or in any specific application or arising from any course of dealing or usage of trade. The user is solely responsible for determining the suitability of the product(s) featured herein for user's intended purpose and in user's specific application. C&D Technologies, Inc. does not warrant or recommend that any of its products be used in any life support or aviation or aerospace applications.