

WP7677C2SURC/G



Technical Data

Features:

- *High Luminance output.
- *Design for High Current Operation.
- *Uniform Color.
- *Low Power Consumption.
- *Low Thermal Resistance.
- *Low Profile.
- *Packaged in tubes for use with automatic insertion equipment.
- *RoHS Compliant.

Benefits:

- *Outstanding Material Efficiency.
- *Electricity savings.
- *Maintenance savings.
- *Reliable and Rugged.

Typical Applications:

- *Automotive Exterior Lighting.
- *Electronic Signs and Signals.
- *Specialty Lighting.

Outline Drawings

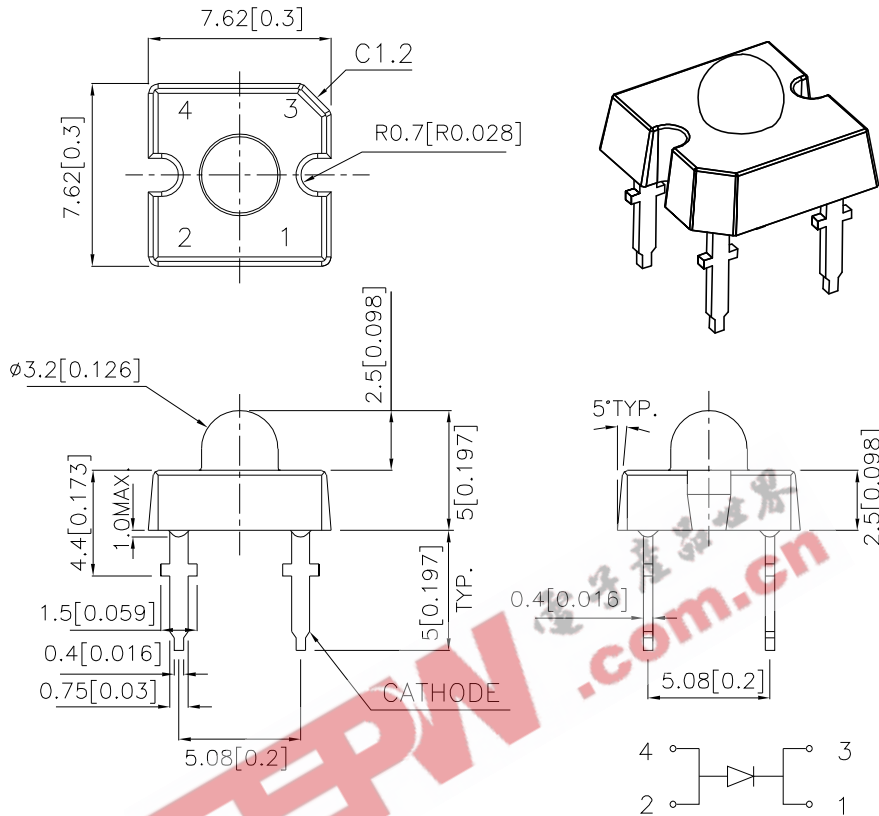

Notes:

1. All dimensions are in millimeters (inches).
2. Tolerance is $\pm 0.25(0.01)$ unless otherwise noted.
3. Lead spacing is measured where the leads emerge from the package.
4. Specifications are subject to change without notice.

Absolute Maximum Ratings at $T_A=25^\circ\text{C}$

PARAMETER	SUR/G	UNITS
DC Forward Current	70	mA
Power dissipation	182	mW
Reverse Voltage	5	V
Operating Temperature	-40 To +85	$^\circ\text{C}$
Storage Temperature	-55 To +85	$^\circ\text{C}$
Lead Solder Temperature ^[1]	260 $^\circ\text{C}$ For 5 Seconds	

1. 1.5mm[0.06inch] below seating plane.

Selection Guide

Part No.	LED COLOR	Iv(cd) ^[1] @70mA		Viewing Angle ^[2]
		Min.	Typ.	2θ1/2 Typ.
WP7677C2SURC/G	DH InGaAlP RED	4.7	8.0	30°

Notes:

- Luminous intensity is measured with an integrating sphere after the device has stabilized.
- θ1/2 is the angle from optical centerline where the luminous intensity is 1/2 the optical centerline value.

Optical Characteristics at TA=25°C

IF=70mA Rθj-a=200°C/W

DEVICE TYPE	PEAK WAVELENGTH λPEAK (nm) TYP.	DOMINANT ^[1] WAVELENGTH λDOM (nm) TYP.	SPECTRAL LINE WAVELENGTH Δλ1/2(nm) TYP.
SUR/G	640	630	22

NOTE:

- The dominant wavelength is derived from the CIE Chromaticity Diagram and represents the perceived color of the device.

Electrical Characteristics at TA=25°C

DEVICE TYPE	FORWARD VOLTAGE VF(VOLTS) @ IF=70mA			REVERSE CURRENT IR (uA) @ VR=5V	CAPACITANCE C (pF) @ VF=0V F=1MHZ	THERMAL RESISTANCE Rθj-pin °C/W
	MIN.	TYP.	MAX.	MAX.	TYP.	TYP.
	SUR/G	2.1	2.3	2.6	10	45

Figures

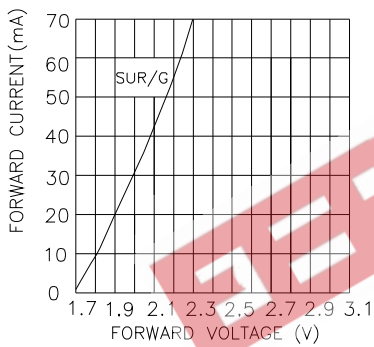
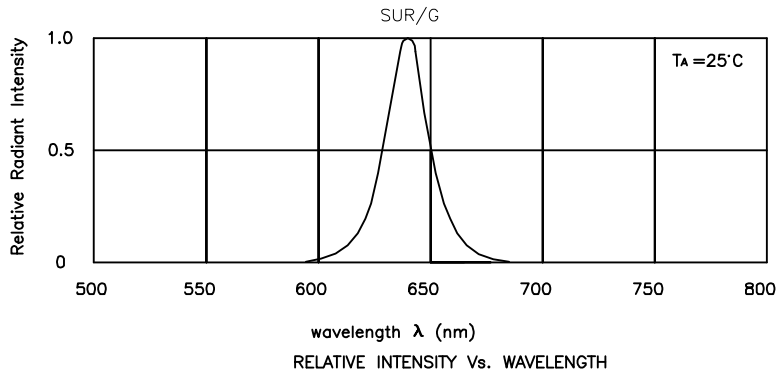

Figure2: FORWARD CURRENT Vs. FORWARD VOLTAGE

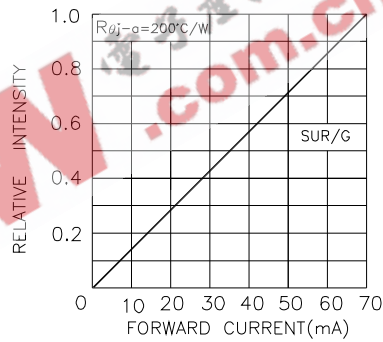

Figure3: RELATIVE INTENSITY Vs. FORWARD CURRENT

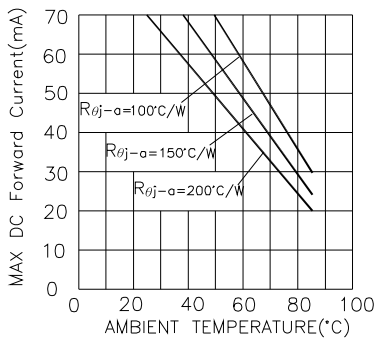

Figure4: SUR/G
MAX DC FORWARD CURRENT Vs AMBIENT TEMPERATURE

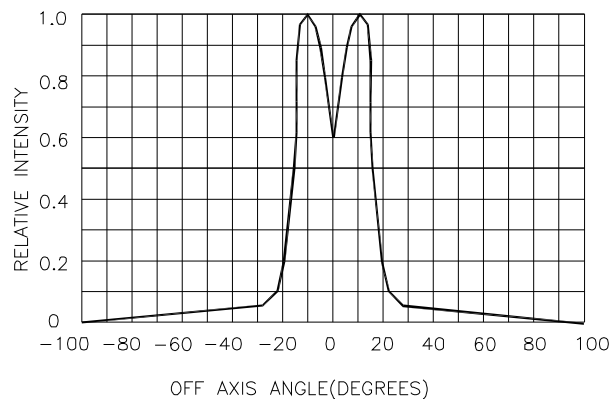
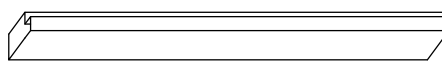
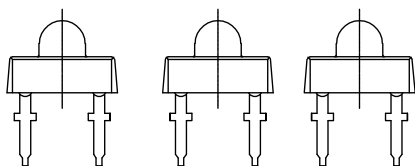

Figure5: RELATIVE INTENSITY VS OFF AXIS ANGLE

PACKING & LABEL SPECIFICATIONS

WP7677C2SURC/G



75PCS / IC TUBE



750pcs / 10pcs IC TUBE



OUTSIDE LABEL

24K / 6# BOX

Kingbright	
Q.C.	<div style="border: 1px solid black; border-radius: 50%; padding: 2px; display: inline-block;"> QC XX XX. XXXX PASSED </div>
TYPE NO : WP7677C2xxx	Date
QUANTITY : 750 pcs	
S/N : XX	CODE: XXX
LOT NO : 	
MADE IN CHINA	RoHS Compliant

Remarks:

If special sorting is required (e.g. binning based on forward voltage, luminous intensity/ luminous flux or wavelength), the typical accuracy of the sorting process is as follows:

1. Wavelength: +/-1nm
2. Luminous Intensity/ Luminous Flux: +/-15%
3. Forward Voltage: +/-0.1V

Note: Accuracy may depend on the sorting parameters.