





### Pre-terminated Cables Simplify Connection of Terminal Blocks to PLC Modules

- Reduce setup time with cables pre-terminated for the exact PLC module in use
- No need to make custom connectors
- Crimp hook-terminated cables connect XW2B terminal blocks with PLC modules and input boards from any manufacturer



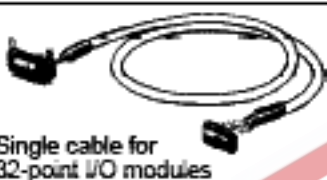
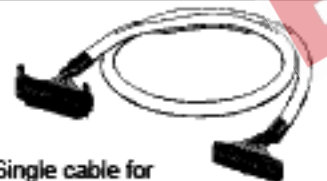

### Ordering Information

#### ■ CABLES

Appearance	Applicable terminal block	Cable length	Part number
 <p>Single cable for 32-point I/O modules</p>	XW2B-20G5 XW2B-20G4 XW2B-20G5-T XW2B-20G5-D XW2B-20G5-IN16	0.5 m (1.64 ft)	XW2Z-050A
		1 m (3.28 ft)	XW2Z-100A
		1.5 m (4.92 ft)	XW2Z-150A
		2 m (6.56 ft)	XW2Z-200A
		3 m (9.84 ft)	XW2Z-300A
		5 m (16.40 ft)	XW2Z-500A
 <p>Single cable for 32- and 64-point I/O modules</p>	XW2B-40G5 XW2B-40G4	0.5 m (1.64 ft)	XW2Z-050B
		1 m (3.28 ft)	XW2Z-100B
		1.5 m (4.92 ft)	XW2Z-150B
		2 m (6.56 ft)	XW2Z-200B
		3 m (9.84 ft)	XW2Z-300B
		5 m (16.40 ft)	XW2Z-500B
 <p>Single cable for CS1W high-density I/O modules</p>	XW2B-60G5 XW2B-60G4	1 m (3.28 ft)	XW2Z-100H-1
		2 m (6.56 ft)	XW2Z-200H-1
		3 m (9.84 ft)	XW2Z-300H-1
		5 m (16.40 ft)	XW2Z-500H-1
 <p>Bifurcated cable for 32- and 64-point I/O modules</p>	XW2C-20G5-IN16	1 m (3.28 ft) and 0.75 m (2.46 ft)	XW2Z-100D
		1.5 m (4.92 ft) and 1.25 m (4.10 ft)	XW2Z-150D
		2 m (6.56 ft) and 1.75 m (5.74 ft)	XW2Z-200D
		3 m (9.84 ft) and 2.75 m (9.02 ft)	XW2Z-300D
		5 m (16.40 ft) and 4.75 m (15.58 ft)	XW2Z-500D
 <p>Bifurcated cable for CS1W high-density I/O modules</p>	XW2B-40G5 and XW2B-20G5	1 m (3.28 ft) and 1 m (3.28 ft)	XW2Z-100H-2
		2 m (6.56 ft) and 2 m (6.56 ft)	XW2Z-200H-2
		3 m (9.84 ft) and 3 m (6.56 ft)	XW2Z-300H-2
		5 m (16.40 ft) and 5 m (16.40 ft)	XW2Z-500H-2

## Cables (continued)

Appearance	Applicable terminal block	Cable length	Part number
 Three-connector cable for 48- and 96-point I/O modules	Three XW2B-20G5	1 m (3.28 ft) and 0.75 m (2.45 ft) and 1 m (3.28 ft)	XW2Z-100H-3
		2 m (6.56 ft) and 1.75 m (5.74 ft) and 2 m (6.56 ft)	XW2Z-200H-3
		3 m (9.84 ft) and 2.75 m (9.02 ft) and 3 m (9.84 ft)	XW2Z-300H-3
		5 m (16.40 ft) and 4.75 m (15.58 ft) and 5 m (16.40 ft)	XW2Z-500H-3
 Single cable terminated with crimp hooks	XW2B-20G5 XW2B-20G4	1 m (3.28 ft)	XW2Z-100F
		1.5 m (4.92 ft)	XW2Z-150F
		2 m (6.56 ft)	XW2Z-200F
		3 m (9.84 ft)	XW2Z-300F
		5 m (16.40 ft)	XW2Z-500F

## Specifications

## ■ RATINGS/CHARACTERISTICS

Item	Rating
Rated current	1 A at 20°C (68°F)
Rated voltage	125 VAC
Contact resistance	20 mΩ max. with 100 mA at 20 mV max. (See Note 1)
Insulation resistance	100 MΩ min. at 500 VDC
Dielectric strength	500 VAC for 1 minute with a current leakage of 1 mA max. (See Note 2)
Enclosure rating	IP00
Electrical protection	Class 0
Ambient temperature	Operating: -25°C to 80°C (-13°F to 176°F)

Note: 1. The resistance indicated is the contact resistance of the connector.

2. The voltage indicated is the dielectric strength of the connector.

## ■ MATERIALS/FINISH

Item	Parts	Materials/Processing		
Connector	XG4M-2030 XG4M-4030 XG4M-6030	Housing	Black PBT resin with glass (UL94V-0)	
		Cover		
		Contact		Contact-carrying portion: Phosphor bronze and nickel plated with 0.15-μm-thick gold Press-fit portion: Phosphor bronze and nickel plated with 2.0-μm-thick tin
	XG4T-2004 XG4T-4004 XG4T-6004	Strain relief	Black PBT resin with glass (UL94V-0)	
		FCN-387J024-AU/F FCN-387J040-AU/F	Housing	Black PBT resin (UL94V-0)
			Contact	Contact-carrying portion: Gold-plated phosphor bronze Press-fit portion: Tin-plated phosphor bronze
		Screw	Nickel-plated steel	
Cable	UL2464 interface cable	Equivalent to AWG28		
Crimp terminal	Fork-type crimp terminal	Equivalent to 1.25YAS3.5		

# Dimensions

Unit: mm (inch)

## ■ XW2Z-□□□A FOR 32-POINT PLC I/O MODULES (CONNECTOR TYPE)

The G79-□C Cable with a connector for the G7TC cannot be used for the XW2C due to a difference in wiring. The G79-□C Cable can be used for some of the XW2B Screw Terminal Blocks, refer to the XW2B data sheet.

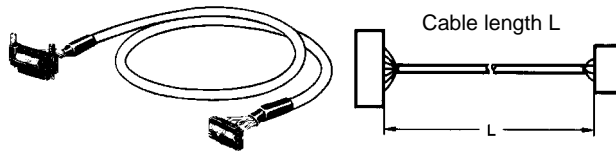

Part number	Cable length L
XW2Z-050A	0.5 m (1.64 ft)
XW2Z-100A	1 m (3.28 ft)
XW2Z-150A	1.5 m (4.92 ft)
XW2Z-200A	2 m (6.56 ft)
XW2Z-300A	3 m (9.84 ft)
XW2Z-500A	5 m (16.40 ft)

## Wiring Diagram

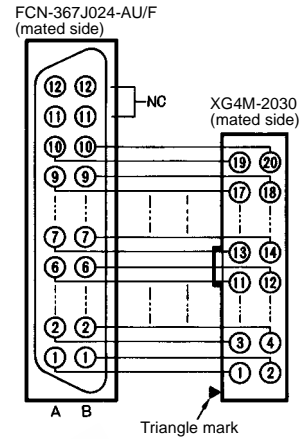

## Combinations of Omron PLC I/O Modules and Screw Terminal Blocks

PLC I/O module	I/O points	Terminal block	Dedicated cable
C200H-ID215 C200H-OD215 C200H-MD215 C200H-MD115 C200H-MD501 C200H-ID501 C200H-OD501 C500-ID218CN C500-ID501CN C500-OD415CN C500-MD211CN C500-OD501CN	32 points input 32 points output 16 points in/16 points out 16 points in/16 points out 16 points in/16 points out 32 points input 32 points output 32 points input 32 points input 32 points output 16 points in/16 points out 32 points output	XW2B-20G5 XW2B-20G4 XW2B-40G5-T XW2B-20G5-D	XW2Z-□□□A
C200H-ID215 C200H-ID501 C500-ID218CN C500-ID501CN C200H-MD215 C200H-MD115 C200H-MD501 C500-MD211CN	32 points input 32 points input 32 points input 32 points input 16 points in/16 points out 16 points in/16 points out 16 points in/16 points out 16 points in/16 points out	XW2C-20G5-IN16 (See Note 3)	

- Note: 1. The G79-□C Cable with a connector for the G7TC cannot be used for the XW2C due to a difference in wiring. The G79-□C Cable can be used for some of the XW2B Screw Terminal Blocks, refer to the XW2B data sheet.
2. The Input or Output Modules above have two connectors, so each one can use up to two Terminal Blocks and two dedicated cables.
3. The XW2C is a dedicated Input Terminal Block. If the XW2C is connected to a PLC module that handles both input and output signals (modules with "MD" in the part number), only the input portion of the PLC module can be used.

Unit: mm (inch)

■ XW2Z-□□□B FOR 32-POINT AND 64-POINT PLC I/O MODULES (CONNECTOR TYPE)

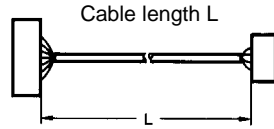
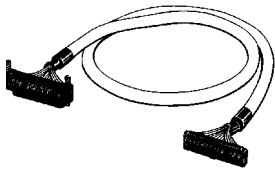

Wiring Diagram

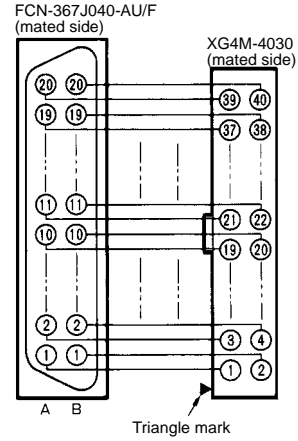

Part number	Cable length L
XW2Z-050B	0.5 m (1.64 ft)
XW2Z-100B	1 m (3.28 ft)
XW2Z-150B	1.5 m (4.92 ft)
XW2Z-200B	2 m (6.56 ft)
XW2Z-300B	3 m (9.84 ft)
XW2Z-500B	5 m (16.40 ft)

Combinations of Omron PLC I/O Modules and Screw Terminal Blocks

PLC I/O module	I/O points	Terminal block	Dedicated cable
CQM1-ID213 CQM1-OD213 C200H-ID216 C200H-OD218 C200H-OD21B	32 points	XW2B-40G5 XW2B-40G4	XW2Z-□□□B
C200H-ID111 C200H-ID217 C200H-OD219 C500-ID114 3G2A5-ID219 3G2A5-OD213	64 points		

Note: 32-point I/O modules use one Terminal Block and one dedicated cable.  
64-point I/O modules use two Terminal Blocks and two dedicated cables.

■ XW2Z-□□□D FOR 32-POINT AND 64-POINT PLC I/O MODULES (CONNECTOR TYPE)

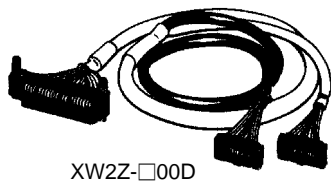

XW2Z-□□□D

Part number	Cable length A	Cable length B
XW2Z-100D	1 m (3.28 ft)	0.75 m (2.46 ft)
XW2Z-150D	1.5 m (4.92 ft)	1.25 m (4.10 ft)
XW2Z-200D	2 m (6.56 ft)	1.75 m (5.74 ft)
XW2Z-300D	3 m (9.84 ft)	2.75 m (9.02 ft)
XW2Z-500D	5 m (16.40 ft)	4.75 m (15.58 ft)

- Note: 1. CN2 (black cable side) is wired to line A of CN1 and CN3 (yellow cable side) is wired to line B of CN1.  
 2. The G79-□C Cable for the G7TC Terminal Block cannot be used for the XW2C due to a difference in wiring.

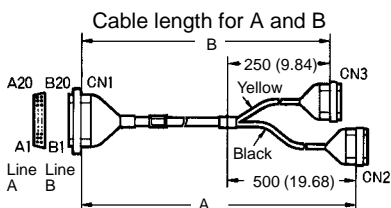

Wiring Diagram

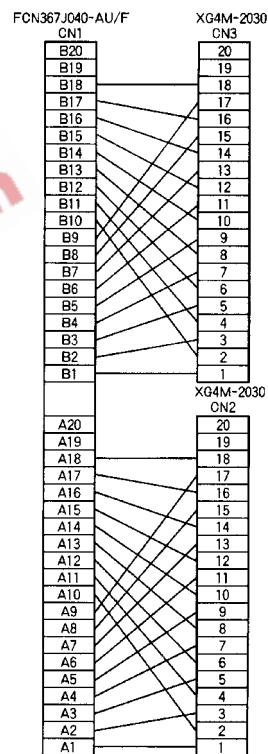
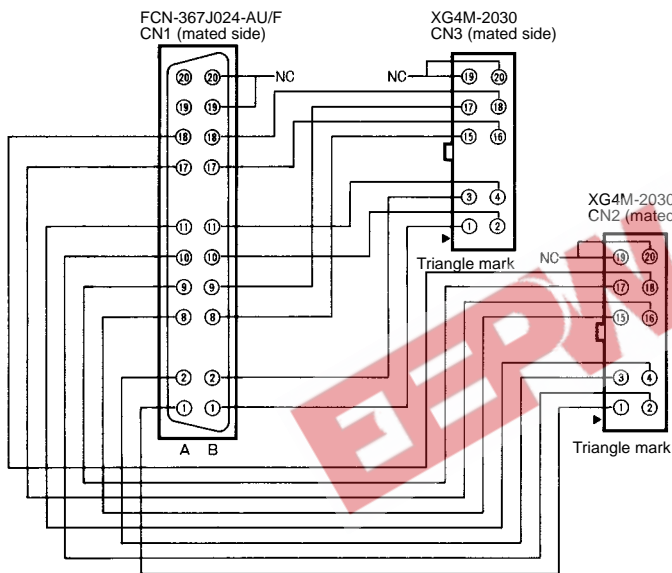

Combinations of Omron PLC I/O Modules and Screw Terminal Blocks

PLC I/O module	I/O points	Terminal block	Dedicated cable
CQM1-ID213 C200H-ID216	32 points	Two XW2C-20GS-IN16 input blocks	One XW2Z-□□□D cable
C200H-ID217 C500-ID114 3G2A5-ID219	64 points	Four XW2C-20GS-IN16 input blocks	Two XW2Z-□□□D cables

Unit: mm (inch)

■ XW2Z-□□□H-□ FOR 96-POINT CS1 PLC I/O MODULES (CONNECTOR TYPE)

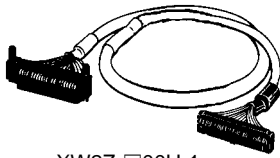

XW2Z-□□□H-1

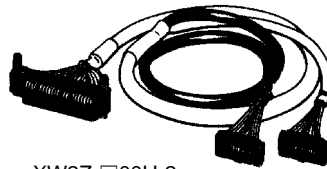

XW2Z-□□□H-2

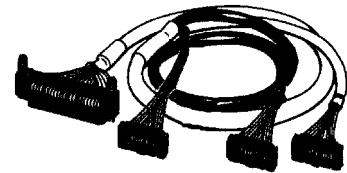

XW2Z-□□□H-3

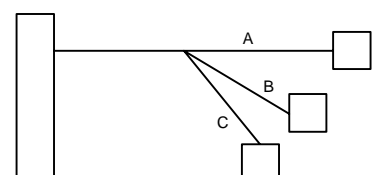
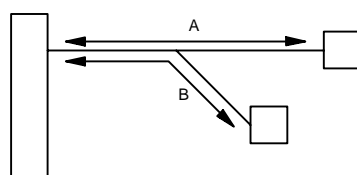
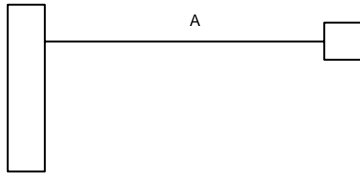

Part number	Cable length A
XW2Z-100H-1	1 m (3.28 ft)
XW2Z-200H-1	2 m (6.56 ft)
XW2Z-300H-1	3 m (9.84 ft)
XW2Z-500H-1	5 m (16.40 ft)

Part number	Cable length		
	A	B	C
XW2Z-100H-3	1 m (3.28 ft)	0.75 ft (2.45 ft)	1 m (3.28 ft)
XW2Z-200H-3	2 m (6.56 ft)	1.75 ft (5.74 ft)	2 m (6.56 ft)
XW2Z-300H-3	3 m (9.84 ft)	2.75 ft (9.02 ft)	3 m (9.84 ft)
XW2Z-500H-3	5 m (16.40 ft)	4.75 ft (15.58 ft)	5 m (16.40 ft)

Part number	Cable length A	Cable length B
XW2Z-100H-2	1 m (3.28 ft)	1 m (3.28 ft)
XW2Z-200H-2	2 m (6.56 ft)	2 m (6.56 ft)
XW2Z-300H-2	3 m (9.84 ft)	3 m (9.84 ft)
XW2Z-500H-2	5 m (16.40 ft)	5 m (16.40 ft)

Combinations of Omron PLC I/O Modules and Screw Terminal Blocks

PLC I/O module	I/O points	Terminal blocks	Dedicated cable
CS1W-ID291, CS1W-OD291, CS1W-OD292 CS1W-MD291, CS1W-MD292	96 points	Two XW2B-60G□ terminal blocks	Two XW2Z-□□□H-1 cables
CS1W-ID291, CS1W-OD291, CS1W-OD292 CS1W-MD291, CS1W-MD292	96 points	Two XW2B-40G4 + XW2B-20G4 or two XW2B-40G5 + XW2B-20G5 terminal blocks	Two XW2Z-□□□H-2 cables
CS1W-ID291, CS1W-OD291, CS1W-OD292 CS1W-MD291, CS1W-MD292	96 points	Six XW2B-20G4 or six XW2B-20G5 terminal blocks	Two XW2Z-□□□H-3 cables

Note: For detailed information about connector pin-outs, refer to CS1 Operation Manual (W339), Appendix A.

■ XW2Z-□□□F CABLE WITH CRIMP TERMINALS (20 POLES)

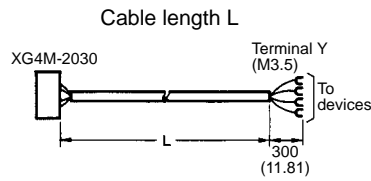
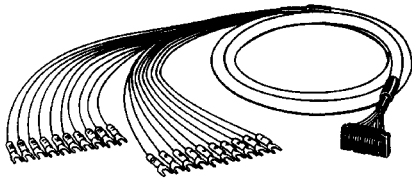

Wiring Diagram

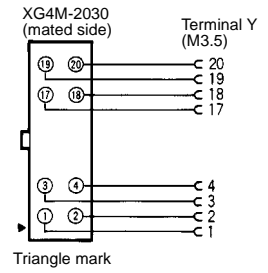



Part number	Cable length L
XW2Z-100F	1 m (3.28 ft)
XW2Z-150F	1.5 m (4.92 ft)
XW2Z-200F	2 m (6.56 ft)
XW2Z-300F	3 m (9.84 ft)
XW2Z-500F	5 m (16.40 ft)

Combinations of Omron PLC I/O Modules and Screw Terminal Blocks

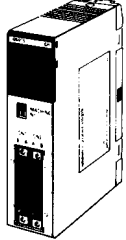
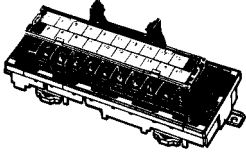
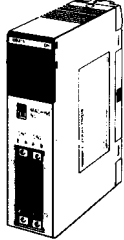
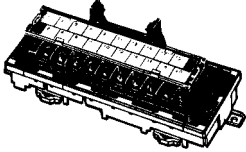
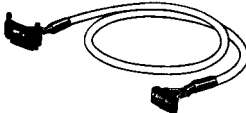
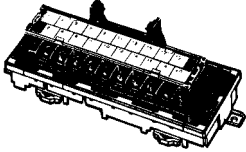
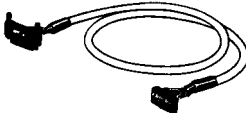
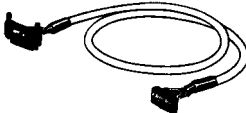

PLC I/O module	Terminal block	Dedicated cable
Use any I/O module with a terminal block from Omron or another manufacturer, or an I/O board for a computer.	XW2B-20G5 XW2B-20G4	XW2Z-□□□F

# Installation

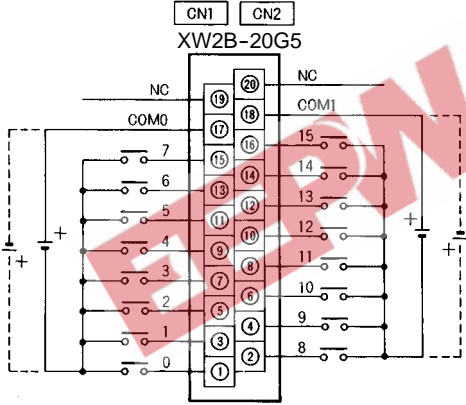
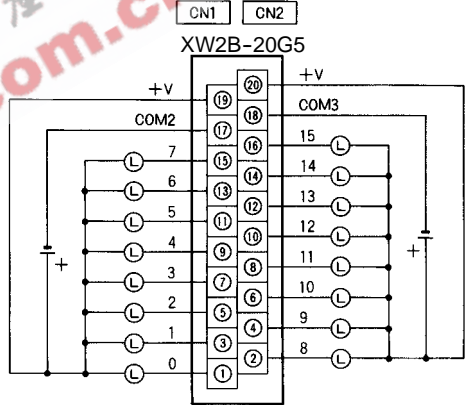
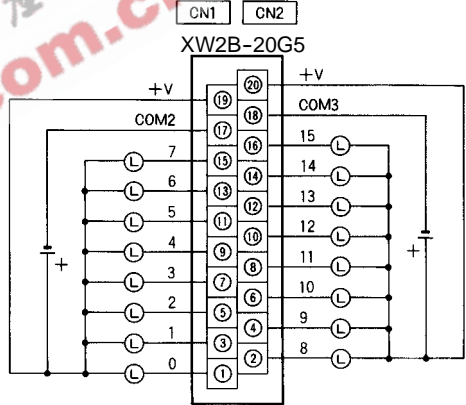
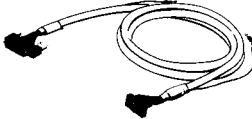
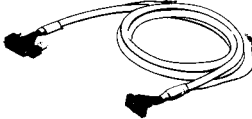
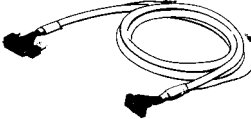
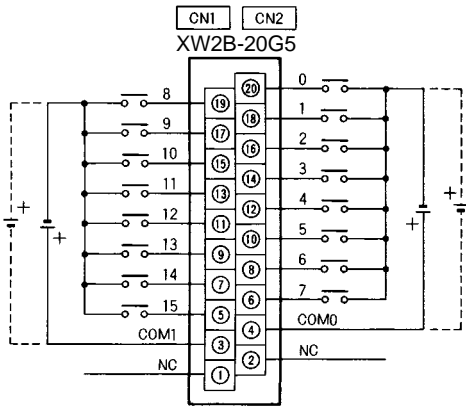
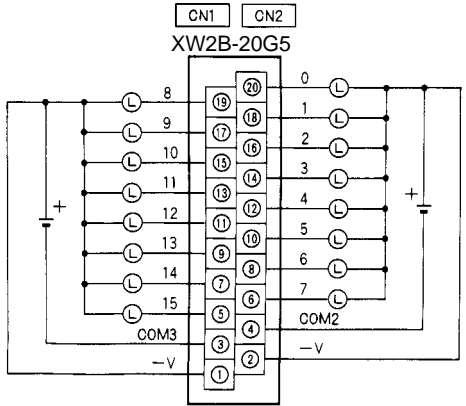
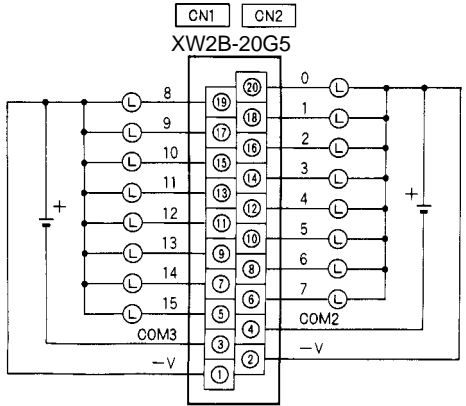
## ■ CONNECTIONS BETWEEN OMRON'S I/O MODULES AND SCREW TERMINAL BLOCKS

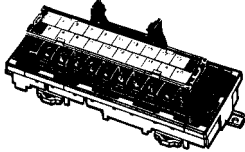
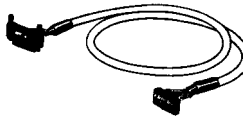

Item	Input (ID)	Output (OD)
PLC I/O modules  <p>C200H-ID215 C200H-ID501 C500-ID501CN C500-ID218CN</p> <p>32-point input modules use two blocks and two cables.</p>	 <p>XW2B-20G5 XW2B-20G4</p>	 <p>C200H-OD215 C200H-OD501 C500-OD501CN</p> <p>32-point output modules use two blocks and two cables.</p>
Terminal blocks  <p>XW2B-20G5 XW2B-20G4</p>	 <p>XW2Z-□□□A</p>	 <p>XW2B-20G5 XW2B-20G4</p>
Cable  <p>XW2Z-□□□A</p>	 <p>XW2Z-□□□A</p>	 <p>XW2Z-□□□A</p>
Connection diagram  <p>CN1 CN2 XW2B-20G5</p> <p>NC COM0 7 6 5 4 3 2 1 0 19 18 17 16 15 14 13 12 11 10 9 8 7 6 5 4 3 2 1</p>	 <p>CN1 CN2 XW2B-20G5</p> <p>+V COM2 7 6 5 4 3 2 1 0 19 18 17 16 15 14 13 12 11 10 9 8 7 6 5 4 3 2 1</p>	 <p>CN1 CN2 XW2B-20G5</p> <p>+V COM3 7 6 5 4 3 2 1 0 19 18 17 16 15 14 13 12 11 10 9 8 7 6 5 4 3 2 1</p>
Cable  <p>G79-□C</p>	 <p>G79-□C</p>	 <p>G79-□C</p>
Connection diagram  <p>CN1 CN2 XW2B-20G5</p> <p>8 9 10 11 12 13 14 15 19 18 17 16 15 14 13 12 11 10 9 8 7 6 5 4 3 2 1</p> <p>COM1 COM0 NC</p>	 <p>CN1 CN2 XW2B-20G5</p> <p>8 9 10 11 12 13 14 15 19 18 17 16 15 14 13 12 11 10 9 8 7 6 5 4 3 2 1</p> <p>COM3 COM2 -V</p>	 <p>CN1 CN2 XW2B-20G5</p> <p>8 9 10 11 12 13 14 15 19 18 17 16 15 14 13 12 11 10 9 8 7 6 5 4 3 2 1</p> <p>COM3 COM2 -V</p>



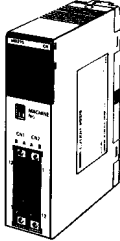
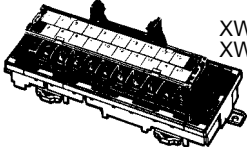
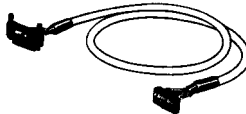
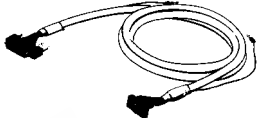
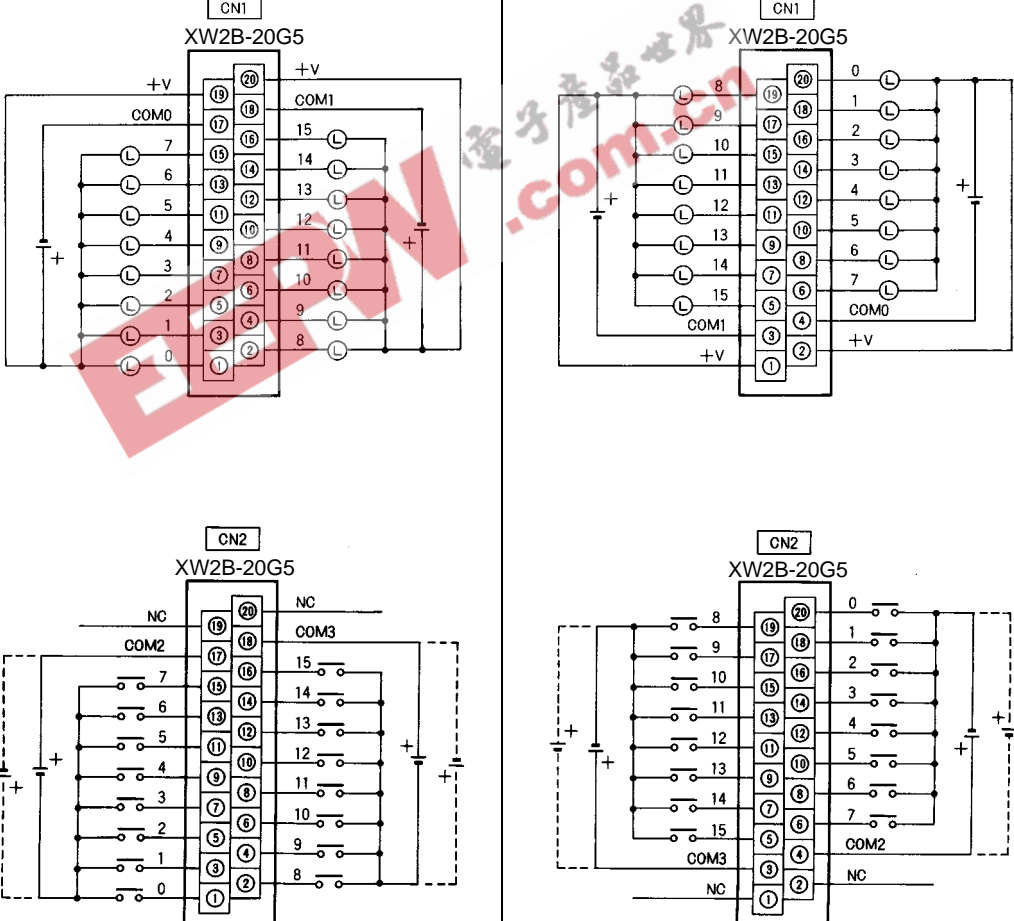

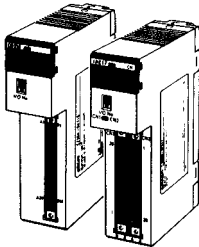
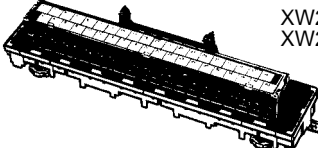
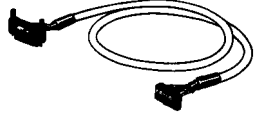
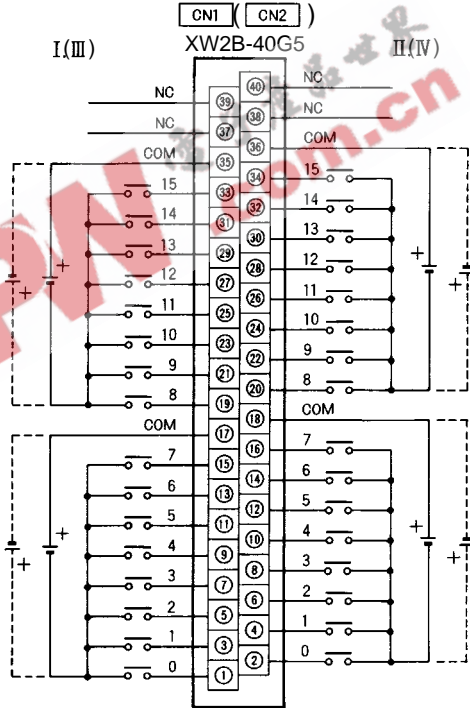
Item	Output (OD)	
PLC I/O module	<div style="display: flex; align-items: center;">  <div> <p>C500-OD415CN</p> <p>32-point output module uses two blocks and two cables.</p> </div> </div>	
Terminal block	<div style="display: flex; align-items: center;">  <div> <p>XW2B-20G5</p> <p>XW2B-20G4</p> </div> </div>	
Cable	<div style="display: flex; align-items: center;">  <p>XW2Z-□□□A</p> </div>	<div style="display: flex; align-items: center;">  <p>G79-□C</p> </div>
Connection diagram	<div style="display: flex; justify-content: space-around;"> <div style="width: 45%;"> <p style="text-align: center;">CN1</p> <p style="text-align: center;">XW2B-20G5</p> </div> <div style="width: 45%;"> <p style="text-align: center;">CN1</p> <p style="text-align: center;">XW2B-20G5</p> </div> </div> <div style="display: flex; justify-content: space-around; margin-top: 20px;"> <div style="width: 45%;"> <p style="text-align: center;">CN2</p> <p style="text-align: center;">XW2B-20G5</p> </div> <div style="width: 45%;"> <p style="text-align: center;">CN2</p> <p style="text-align: center;">XW2B-20G5</p> </div> </div>	

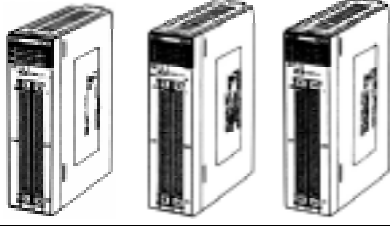
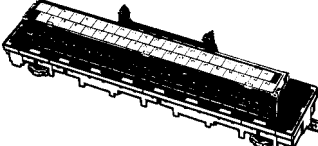
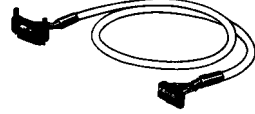

Item	Mixed I/O (MD)	
PLC I/O modules	 <p>C200H-MD115 C200H-MD215 C200H-MD501 C500-MD211CN</p> <p>16-point input/16-point output mixed I/O modules use two blocks and two cables.</p>	
Terminal blocks	 <p>XW2B-20G5 XW2B-20G4</p>	
Cable	 <p>XW2Z-□□□A</p>	 <p>G79-□C</p>
Connection diagram	 <p>The connection diagrams show the wiring for two terminal blocks (CN1 and CN2) on the XW2B-20G5 module. Each diagram includes a power source (+V) and a common terminal (COM). The diagrams illustrate the connection of 16 input/output points (L0-L15) to the terminal block pins (1-20).</p>	

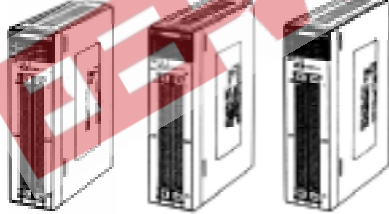
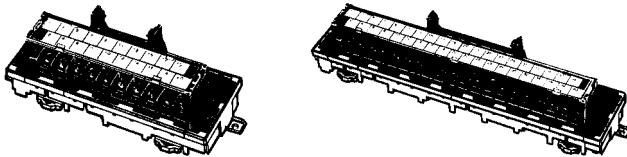
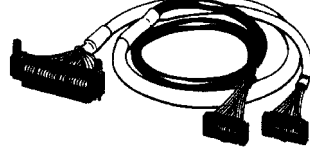
Item	Group 2 High-density Input/Output																											
PLC I/O module	 <table border="0"> <tr> <td>CQM1-ID213</td> <td>32-point</td> <td>Use one terminal block and one cable.</td> </tr> <tr> <td>C200H-ID216</td> <td>32-point</td> <td>Use one terminal block and one cable.</td> </tr> <tr> <td>C200H-ID111</td> <td>64-point</td> <td>Use two terminal blocks and two cables.</td> </tr> <tr> <td>C200H-ID217</td> <td>64-point</td> <td>Use two terminal blocks and two cables.</td> </tr> <tr> <td>C500-ID114</td> <td>64-point</td> <td>Use two terminal blocks and two cables.</td> </tr> <tr> <td>3G2A5-ID219</td> <td>64-point</td> <td>Use two terminal blocks and two cables.</td> </tr> <tr> <td>CQM1-OD213</td> <td>32-point</td> <td>Use one terminal block and one cable.</td> </tr> <tr> <td>C200H-OD218</td> <td>32-point</td> <td>Use one terminal block and one cable.</td> </tr> <tr> <td>C200H-OD219</td> <td>64-point</td> <td>Use two terminal blocks and two cables.</td> </tr> </table>	CQM1-ID213	32-point	Use one terminal block and one cable.	C200H-ID216	32-point	Use one terminal block and one cable.	C200H-ID111	64-point	Use two terminal blocks and two cables.	C200H-ID217	64-point	Use two terminal blocks and two cables.	C500-ID114	64-point	Use two terminal blocks and two cables.	3G2A5-ID219	64-point	Use two terminal blocks and two cables.	CQM1-OD213	32-point	Use one terminal block and one cable.	C200H-OD218	32-point	Use one terminal block and one cable.	C200H-OD219	64-point	Use two terminal blocks and two cables.
CQM1-ID213	32-point	Use one terminal block and one cable.																										
C200H-ID216	32-point	Use one terminal block and one cable.																										
C200H-ID111	64-point	Use two terminal blocks and two cables.																										
C200H-ID217	64-point	Use two terminal blocks and two cables.																										
C500-ID114	64-point	Use two terminal blocks and two cables.																										
3G2A5-ID219	64-point	Use two terminal blocks and two cables.																										
CQM1-OD213	32-point	Use one terminal block and one cable.																										
C200H-OD218	32-point	Use one terminal block and one cable.																										
C200H-OD219	64-point	Use two terminal blocks and two cables.																										
Terminal block	 <p>XW2B-40G5 XW2B-40G4</p>																											
Cable	 <p>XW2Z-□□□B</p>																											
Connection diagram	 <p>The diagram shows the wiring for the XW2B-40G5 terminal block. It is divided into two sections: I(III) on the left and II(IV) on the right. Each section has 16 channels. Channel 0 is COM, channels 1-15 are NC, and channels 16-31 are COM. The diagram shows the internal switch connections and the external power supply connections (+) for each channel.</p>																											

Item	High-density I/O 1:1 Connection
PLC I/O module	 <p>CS1W-ID29□ CS1W-OD29□ CS1W-MD29□</p> <p>Use two terminal blocks and two cables.</p>
Terminal block	 <p>One XW2B-60G5 or one XW2B-60G4 per cable</p>
Cable	 <p>XW2Z-□□□H-1</p>
Connection	<p>XW2B-60G□</p> 

Item	High-density I/O 1:2 Connection
PLC I/O module	 <p>CS1W-ID29□ CS1W-OD29□ CS1W-MD29□</p> <p>Use two 40-point and two 20-point terminal blocks and two cables.</p>
Terminal block	 <p>XW2B-40G5 + XW2B-20G5 blocks or XW2B-40G4 + XW2B-20G4 blocks per cable</p>
Cable	 <p>XW2Z-□□□H-2</p>
Connection	<p>XW2B-40G□</p>  <p>XW2B-20G□</p> 

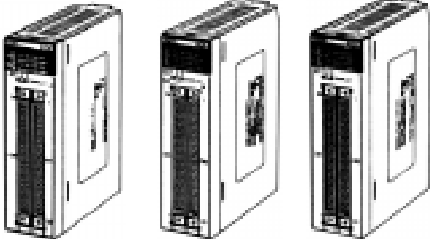
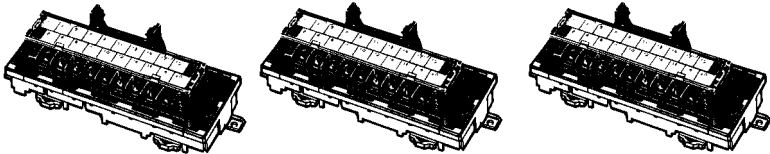
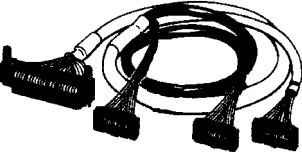
Note: For detailed information about connector pin-outs, refer to CS1 Operation Manual (W339), Appendix A.

Item	High-density I/O 1:3 Connection
PLC I/O module	 <p data-bbox="994 389 1139 454">CS1W-ID29□ CS1W-OD29□ CS1W-MD29□</p> <p data-bbox="994 474 1326 517">Use six 20-point terminal blocks of the same kind and two cables.</p>
Terminal block	 <p data-bbox="1166 595 1445 660">Three XW2B-20G5 blocks or three XW2B-20G4 blocks per cable</p>
Cable	 <p data-bbox="1015 817 1177 842">XW2Z-□□□H-3</p>
Connection	 <p data-bbox="384 936 512 960">XW2B-20G□</p> <p data-bbox="735 936 863 960">XW2B-20G□</p> <p data-bbox="1082 936 1209 960">XW2B-20G□</p>

Note: For detailed information about connector pin-outs, refer to CS1 Operation Manual (W339), Appendix A.

**NOTE: DIMENSIONS SHOWN ARE IN MILLIMETERS. To convert millimeters to inches divide by 25.4.**

**OMRON**<sup>®</sup>  
**OMRON ELECTRONICS, INC.**  
 One East Commerce Drive  
 Schaumburg, IL 60173  
**1-800-55-OMRON**

**OMRON CANADA, INC.**  
 885 Milner Avenue  
 Scarborough, Ontario M1B 5V8  
**416-286-6465**