





Pre-terminated Cables Simplify Connection of Terminal Blocks to PLC Modules

- Reduce setup time with cables pre-terminated for the exact PLC module in use
- No need to make custom connectors
- Crimp hook-terminated cables connect XW2B terminal blocks with PLC modules and input boards from any manufacturer



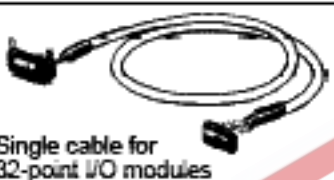
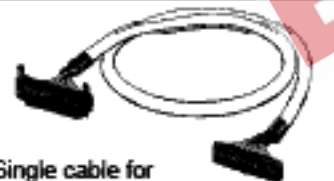

Ordering Information

■ CABLES

| Appearance | Applicable terminal block | Cable length | Part number |
|---|--|--------------------------------------|-------------|
|  <p>Single cable for 32-point I/O modules</p> | XW2B-20G5 XW2B-20G4 XW2B-20G5-T XW2B-20G5-D XW2B-20G5-IN16 | 0.5 m (1.64 ft) | XW2Z-050A |
| | | 1 m (3.28 ft) | XW2Z-100A |
| | | 1.5 m (4.92 ft) | XW2Z-150A |
| | | 2 m (6.56 ft) | XW2Z-200A |
| | | 3 m (9.84 ft) | XW2Z-300A |
| | | 5 m (16.40 ft) | XW2Z-500A |
|  <p>Single cable for 32- and 64-point I/O modules</p> | XW2B-40G5 XW2B-40G4 | 0.5 m (1.64 ft) | XW2Z-050B |
| | | 1 m (3.28 ft) | XW2Z-100B |
| | | 1.5 m (4.92 ft) | XW2Z-150B |
| | | 2 m (6.56 ft) | XW2Z-200B |
| | | 3 m (9.84 ft) | XW2Z-300B |
| | | 5 m (16.40 ft) | XW2Z-500B |
|  <p>Single cable for CS1W high-density I/O modules</p> | XW2B-60G5 XW2B-60G4 | 1 m (3.28 ft) | XW2Z-100H-1 |
| | | 2 m (6.56 ft) | XW2Z-200H-1 |
| | | 3 m (9.84 ft) | XW2Z-300H-1 |
| | | 5 m (16.40 ft) | XW2Z-500H-1 |
|  <p>Bifurcated cable for 32- and 64-point I/O modules</p> | XW2C-20G5-IN16 | 1 m (3.28 ft) and 0.75 m (2.46 ft) | XW2Z-100D |
| | | 1.5 m (4.92 ft) and 1.25 m (4.10 ft) | XW2Z-150D |
| | | 2 m (6.56 ft) and 1.75 m (5.74 ft) | XW2Z-200D |
| | | 3 m (9.84 ft) and 2.75 m (9.02 ft) | XW2Z-300D |
| | | 5 m (16.40 ft) and 4.75 m (15.58 ft) | XW2Z-500D |
|  <p>Bifurcated cable for CS1W high-density I/O modules</p> | XW2B-40G5 and XW2B-20G5 | 1 m (3.28 ft) and 1 m (3.28 ft) | XW2Z-100H-2 |
| | | 2 m (6.56 ft) and 2 m (6.56 ft) | XW2Z-200H-2 |
| | | 3 m (9.84 ft) and 3 m (6.56 ft) | XW2Z-300H-2 |
| | | 5 m (16.40 ft) and 5 m (16.40 ft) | XW2Z-500H-2 |

Cables (continued)

| Appearance | Applicable terminal block | Cable length | Part number |
|---|---------------------------|---|-------------|
|  Three-connector cable for 48- and 96-point I/O modules | Three XW2B-20G5 | 1 m (3.28 ft) and 0.75 m (2.45 ft) and 1 m (3.28 ft) | XW2Z-100H-3 |
| | | 2 m (6.56 ft) and 1.75 m (5.74 ft) and 2 m (6.56 ft) | XW2Z-200H-3 |
| | | 3 m (9.84 ft) and 2.75 m (9.02 ft) and 3 m (9.84 ft) | XW2Z-300H-3 |
| | | 5 m (16.40 ft) and 4.75 m (15.58 ft) and 5 m (16.40 ft) | XW2Z-500H-3 |
|  Single cable terminated with crimp hooks | XW2B-20G5 XW2B-20G4 | 1 m (3.28 ft) | XW2Z-100F |
| | | 1.5 m (4.92 ft) | XW2Z-150F |
| | | 2 m (6.56 ft) | XW2Z-200F |
| | | 3 m (9.84 ft) | XW2Z-300F |
| | | 5 m (16.40 ft) | XW2Z-500F |

Specifications

■ RATINGS/CHARACTERISTICS

| Item | Rating |
|-----------------------|---|
| Rated current | 1 A at 20°C (68°F) |
| Rated voltage | 125 VAC |
| Contact resistance | 20 mΩ max. with 100 mA at 20 mV max. (See Note 1) |
| Insulation resistance | 100 MΩ min. at 500 VDC |
| Dielectric strength | 500 VAC for 1 minute with a current leakage of 1 mA max. (See Note 2) |
| Enclosure rating | IP00 |
| Electrical protection | Class 0 |
| Ambient temperature | Operating: -25°C to 80°C (-13°F to 176°F) |

Note: 1. The resistance indicated is the contact resistance of the connector.

2. The voltage indicated is the dielectric strength of the connector.

■ MATERIALS/FINISH

| Item | Parts | Materials/Processing | | |
|----------------|-------------------------------------|--------------------------------------|--------------------------------------|---|
| Connector | XG4M-2030 XG4M-4030 XG4M-6030 | Housing | Black PBT resin with glass (UL94V-0) | |
| | | Cover | | |
| | | Contact | | Contact-carrying portion: Phosphor bronze and nickel plated with 0.15-μm-thick gold Press-fit portion: Phosphor bronze and nickel plated with 2.0-μm-thick tin |
| | XG4T-2004 XG4T-4004 XG4T-6004 | Strain relief | Black PBT resin with glass (UL94V-0) | |
| | | FCN-387J024-AU/F FCN-387J040-AU/F | Housing | Black PBT resin (UL94V-0) |
| | | | Contact | Contact-carrying portion: Gold-plated phosphor bronze Press-fit portion: Tin-plated phosphor bronze |
| | | Screw | Nickel-plated steel | |
| Cable | UL2464 interface cable | Equivalent to AWG28 | | |
| Crimp terminal | Fork-type crimp terminal | Equivalent to 1.25YAS3.5 | | |

Dimensions

Unit: mm (inch)

■ XW2Z-□□□A FOR 32-POINT PLC I/O MODULES (CONNECTOR TYPE)

The G79-□C Cable with a connector for the G7TC cannot be used for the XW2C due to a difference in wiring. The G79-□C Cable can be used for some of the XW2B Screw Terminal Blocks, refer to the XW2B data sheet.

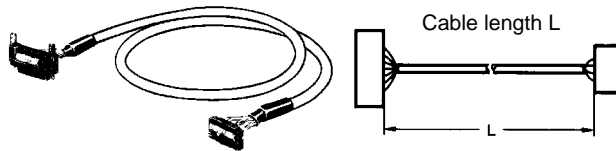

| Part number | Cable length L |
|-------------|-----------------|
| XW2Z-050A | 0.5 m (1.64 ft) |
| XW2Z-100A | 1 m (3.28 ft) |
| XW2Z-150A | 1.5 m (4.92 ft) |
| XW2Z-200A | 2 m (6.56 ft) |
| XW2Z-300A | 3 m (9.84 ft) |
| XW2Z-500A | 5 m (16.40 ft) |

Wiring Diagram

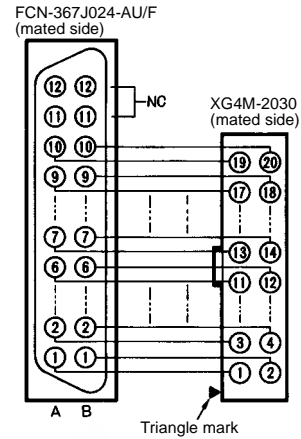

Combinations of Omron PLC I/O Modules and Screw Terminal Blocks

| PLC I/O module | I/O points | Terminal block | Dedicated cable |
|---|--|--|-----------------|
| C200H-ID215 C200H-OD215 C200H-MD215 C200H-MD115 C200H-MD501 C200H-ID501 C200H-OD501 C500-ID218CN C500-ID501CN C500-OD415CN C500-MD211CN C500-OD501CN | 32 points input 32 points output 16 points in/16 points out 16 points in/16 points out 16 points in/16 points out 32 points input 32 points output 32 points input 32 points input 32 points output 16 points in/16 points out 32 points output | XW2B-20G5 XW2B-20G4 XW2B-40G5-T XW2B-20G5-D | XW2Z-□□□A |
| C200H-ID215 C200H-ID501 C500-ID218CN C500-ID501CN C200H-MD215 C200H-MD115 C200H-MD501 C500-MD211CN | 32 points input 32 points input 32 points input 32 points input 16 points in/16 points out 16 points in/16 points out 16 points in/16 points out 16 points in/16 points out | XW2C-20G5-IN16 (See Note 3) | |

- Note: 1. The G79-□ Cable with a connector for the G7TC cannot be used for the XW2C due to a difference in wiring. The G79-□C Cable can be used for some of the XW2B Screw Terminal Blocks, refer to the XW2B data sheet.
2. The Input or Output Modules above have two connectors, so each one can use up to two Terminal Blocks and two dedicated cables.
3. The XW2C is a dedicated Input Terminal Block. If the XW2C is connected to a PLC module that handles both input and output signals (modules with "MD" in the part number), only the input portion of the PLC module can be used.

Unit: mm (inch)

■ XW2Z-□□□B FOR 32-POINT AND 64-POINT PLC I/O MODULES (CONNECTOR TYPE)

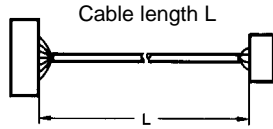
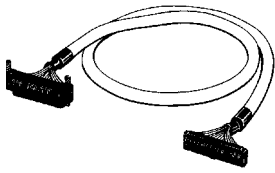

Wiring Diagram

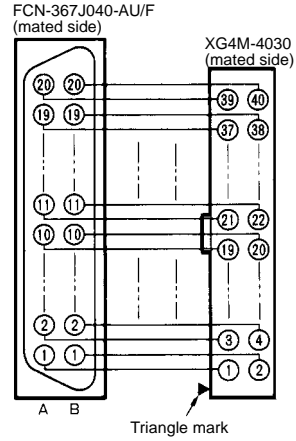

| Part number | Cable length L |
|-------------|-----------------|
| XW2Z-050B | 0.5 m (1.64 ft) |
| XW2Z-100B | 1 m (3.28 ft) |
| XW2Z-150B | 1.5 m (4.92 ft) |
| XW2Z-200B | 2 m (6.56 ft) |
| XW2Z-300B | 3 m (9.84 ft) |
| XW2Z-500B | 5 m (16.40 ft) |

Combinations of Omron PLC I/O Modules and Screw Terminal Blocks

| PLC I/O module | I/O points | Terminal block | Dedicated cable |
|---|------------|------------------------|-----------------|
| CQM1-ID213 CQM1-OD213 C200H-ID216 C200H-OD218 C200H-OD21B | 32 points | XW2B-40G5 XW2B-40G4 | XW2Z-□□□B |
| C200H-ID111 C200H-ID217 C200H-OD219 C500-ID114 3G2A5-ID219 3G2A5-OD213 | 64 points | | |

Note: 32-point I/O modules use one Terminal Block and one dedicated cable.
64-point I/O modules use two Terminal Blocks and two dedicated cables.

■ XW2Z-□□□D FOR 32-POINT AND 64-POINT PLC I/O MODULES (CONNECTOR TYPE)

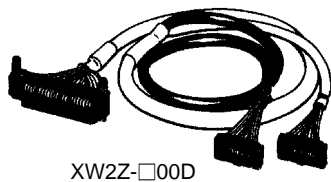

XW2Z-□□□D

| Part number | Cable length A | Cable length B |
|-------------|-----------------|-------------------|
| XW2Z-100D | 1 m (3.28 ft) | 0.75 m (2.46 ft) |
| XW2Z-150D | 1.5 m (4.92 ft) | 1.25 m (4.10 ft) |
| XW2Z-200D | 2 m (6.56 ft) | 1.75 m (5.74 ft) |
| XW2Z-300D | 3 m (9.84 ft) | 2.75 m (9.02 ft) |
| XW2Z-500D | 5 m (16.40 ft) | 4.75 m (15.58 ft) |

- Note: 1. CN2 (black cable side) is wired to line A of CN1 and CN3 (yellow cable side) is wired to line B of CN1.
 2. The G79-□C Cable for the G7TC Terminal Block cannot be used for the XW2C due to a difference in wiring.

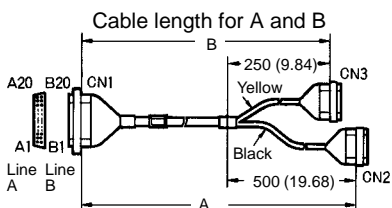

Wiring Diagram

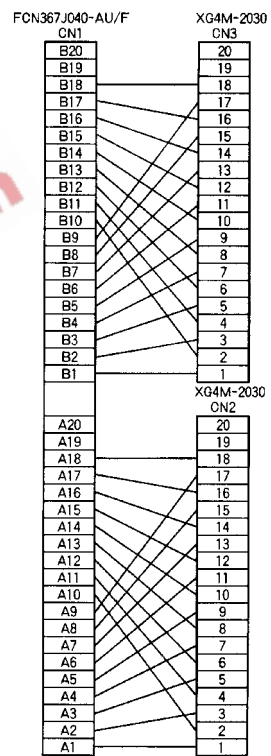
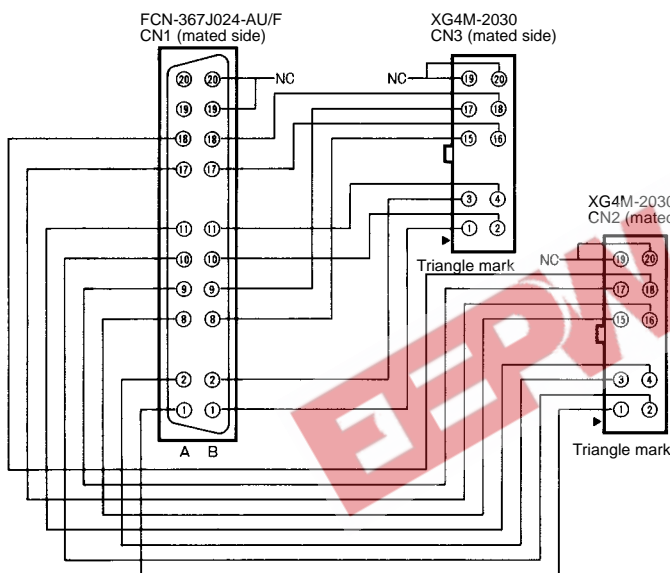

Combinations of Omron PLC I/O Modules and Screw Terminal Blocks

| PLC I/O module | I/O points | Terminal block | Dedicated cable |
|--|------------|----------------------------------|----------------------|
| CQM1-ID213 C200H-ID216 | 32 points | Two XW2C-20GS-IN16 input blocks | One XW2Z-□□□D cable |
| C200H-ID217 C500-ID114 3G2A5-ID219 | 64 points | Four XW2C-20GS-IN16 input blocks | Two XW2Z-□□□D cables |

Unit: mm (inch)

■ XW2Z-□□□H-□ FOR 96-POINT CS1 PLC I/O MODULES (CONNECTOR TYPE)

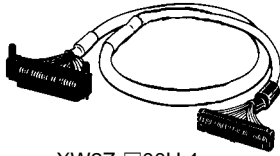

XW2Z-□□□H-1

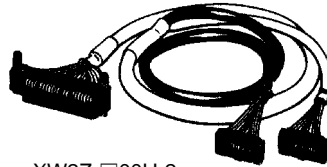

XW2Z-□□□H-2

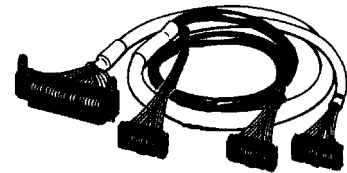

XW2Z-□□□H-3

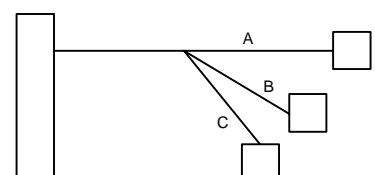
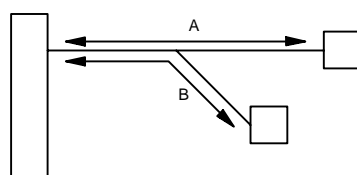
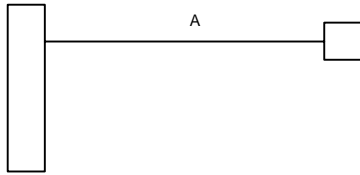

| Part number | Cable length A |
|-------------|----------------|
| XW2Z-100H-1 | 1 m (3.28 ft) |
| XW2Z-200H-1 | 2 m (6.56 ft) |
| XW2Z-300H-1 | 3 m (9.84 ft) |
| XW2Z-500H-1 | 5 m (16.40 ft) |

| Part number | Cable length | | |
|-------------|----------------|--------------------|----------------|
| | A | B | C |
| XW2Z-100H-3 | 1 m (3.28 ft) | 0.75 ft (2.45 ft) | 1 m (3.28 ft) |
| XW2Z-200H-3 | 2 m (6.56 ft) | 1.75 ft (5.74 ft) | 2 m (6.56 ft) |
| XW2Z-300H-3 | 3 m (9.84 ft) | 2.75 ft (9.02 ft) | 3 m (9.84 ft) |
| XW2Z-500H-3 | 5 m (16.40 ft) | 4.75 ft (15.58 ft) | 5 m (16.40 ft) |

| Part number | Cable length A | Cable length B |
|-------------|----------------|----------------|
| XW2Z-100H-2 | 1 m (3.28 ft) | 1 m (3.28 ft) |
| XW2Z-200H-2 | 2 m (6.56 ft) | 2 m (6.56 ft) |
| XW2Z-300H-2 | 3 m (9.84 ft) | 3 m (9.84 ft) |
| XW2Z-500H-2 | 5 m (16.40 ft) | 5 m (16.40 ft) |

Combinations of Omron PLC I/O Modules and Screw Terminal Blocks

| PLC I/O module | I/O points | Terminal blocks | Dedicated cable |
|---|------------|--|------------------------|
| CS1W-ID291, CS1W-OD291, CS1W-OD292 CS1W-MD291, CS1W-MD292 | 96 points | Two XW2B-60G□ terminal blocks | Two XW2Z-□□□H-1 cables |
| CS1W-ID291, CS1W-OD291, CS1W-OD292 CS1W-MD291, CS1W-MD292 | 96 points | Two XW2B-40G4 + XW2B-20G4 or two XW2B-40G5 + XW2B-20G5 terminal blocks | Two XW2Z-□□□H-2 cables |
| CS1W-ID291, CS1W-OD291, CS1W-OD292 CS1W-MD291, CS1W-MD292 | 96 points | Six XW2B-20G4 or six XW2B-20G5 terminal blocks | Two XW2Z-□□□H-3 cables |

Note: For detailed information about connector pin-outs, refer to CS1 Operation Manual (W339), Appendix A.

■ XW2Z-□□□F CABLE WITH CRIMP TERMINALS (20 POLES)

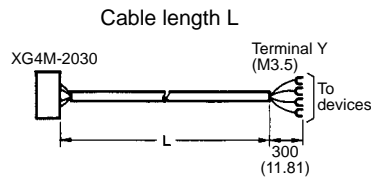
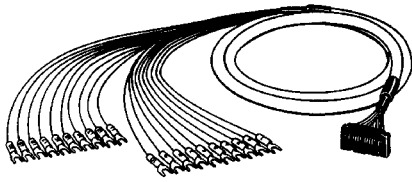

Wiring Diagram

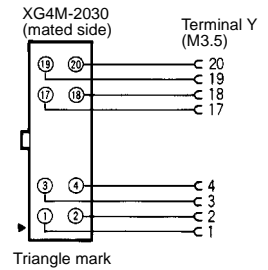





| Part number | Cable length L |
|-------------|-----------------|
| XW2Z-100F | 1 m (3.28 ft) |
| XW2Z-150F | 1.5 m (4.92 ft) |
| XW2Z-200F | 2 m (6.56 ft) |
| XW2Z-300F | 3 m (9.84 ft) |
| XW2Z-500F | 5 m (16.40 ft) |

Combinations of Omron PLC I/O Modules and Screw Terminal Blocks

| PLC I/O module | Terminal block | Dedicated cable |
|--|------------------------|-----------------|
| Use any I/O module with a terminal block from Omron or another manufacturer, or an I/O board for a computer. | XW2B-20G5 XW2B-20G4 | XW2Z-□□□F |

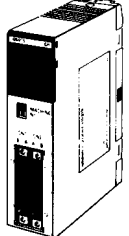
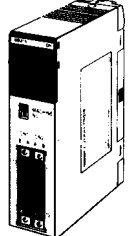
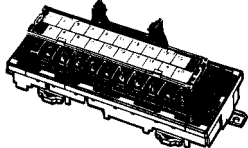
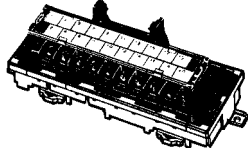
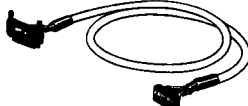
Installation

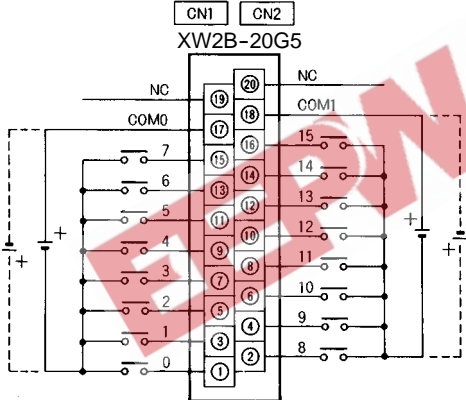
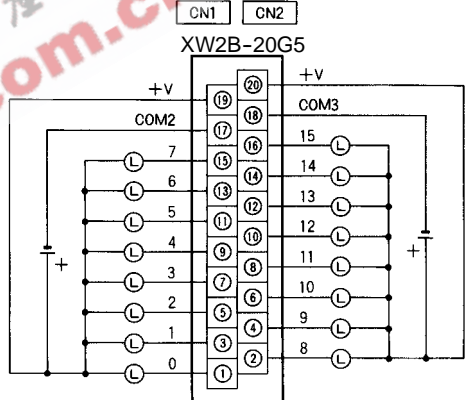

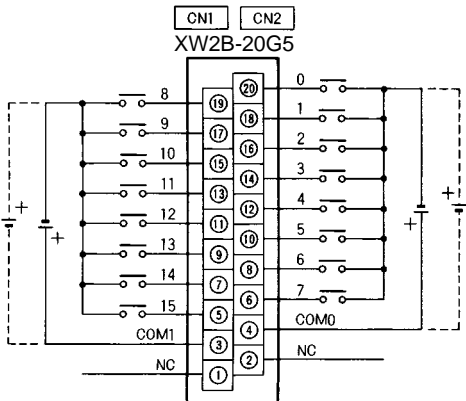
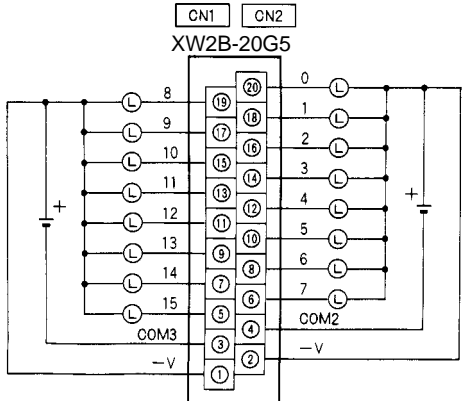
■ CONNECTIONS BETWEEN OMRON'S I/O MODULES AND SCREW TERMINAL BLOCKS

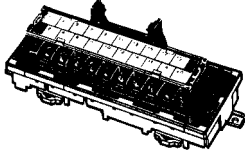
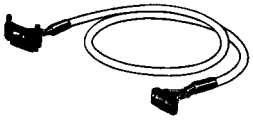
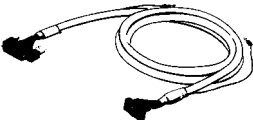
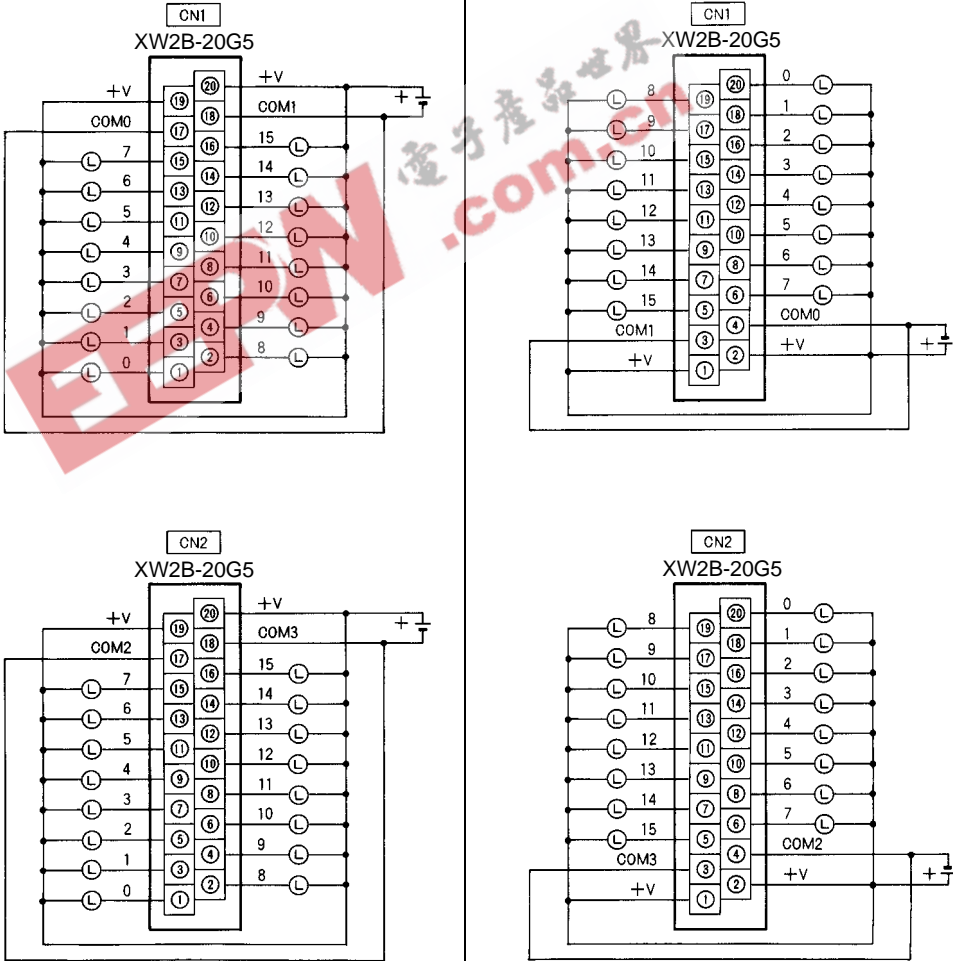

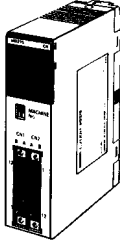
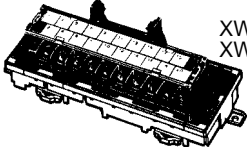
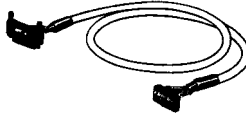
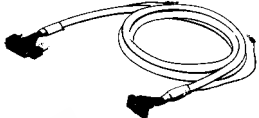
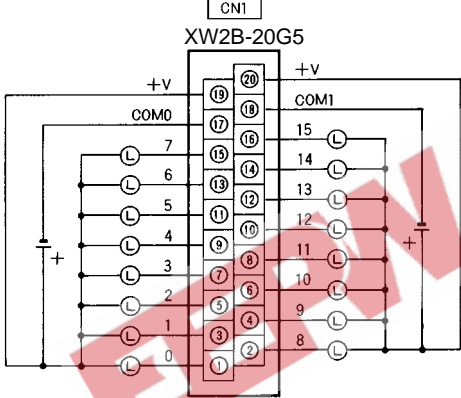
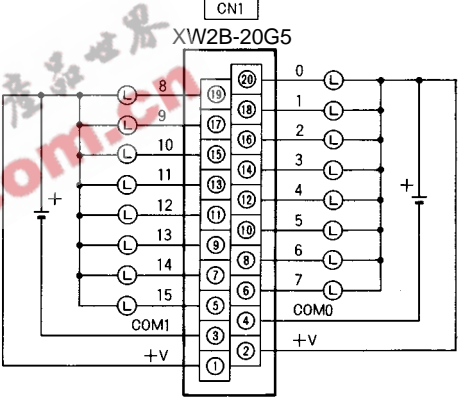
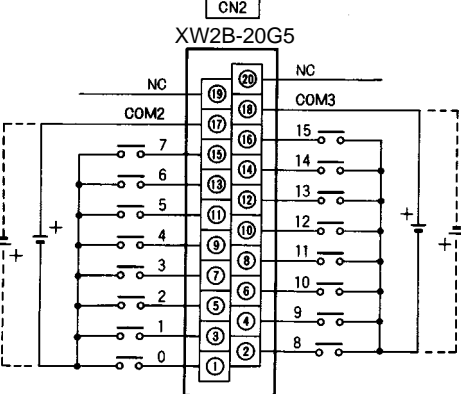
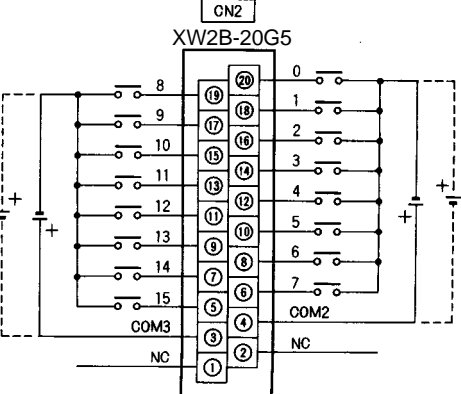
| Item | Input (ID) | Output (OD) |
|--------------------|---|--|
| PLC I/O modules |  <p>C200H-ID215 C200H-ID501 C500-ID501CN C500-ID218CN</p> <p>32-point input modules use two blocks and two cables.</p> |  <p>C200H-OD215 C200H-OD501 C500-OD501CN</p> <p>32-point output modules use two blocks and two cables.</p> |
| Terminal blocks |  <p>XW2B-20G5 XW2B-20G4</p> |  <p>XW2B-20G5 XW2B-20G4</p> |
| Cable |  <p>XW2Z-□□□A</p> |  <p>XW2Z-□□□A</p> |
| Connection diagram |  <p>CN1 CN2 XW2B-20G5</p> |  <p>CN1 CN2 XW2B-20G5</p> |
| Cable |  <p>G79-□C</p> |  <p>G79-□C</p> |
| Connection diagram |  <p>CN1 CN2 XW2B-20G5</p> |  <p>CN1 CN2 XW2B-20G5</p> |

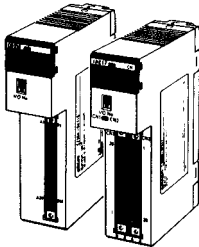
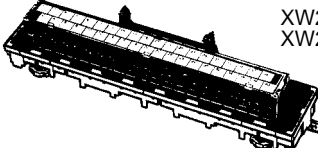
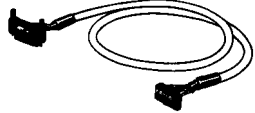
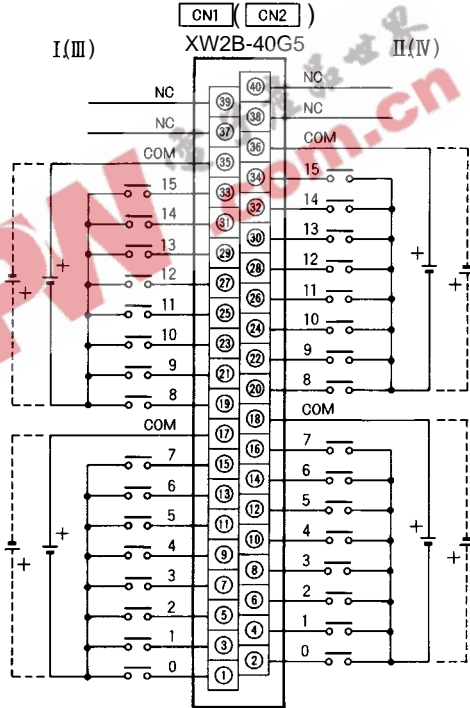
| Item | Output (OD) | |
|--------------------|--|---|
| PLC I/O module |  <p>C500-OD415CN 32-point output module uses two blocks and two cables.</p> | |
| Terminal block |  <p>XW2B-20G5 XW2B-20G4</p> | |
| Cable |  <p>XW2Z-□□□A</p> |  <p>G79-□C</p> |
| Connection diagram |  <p>The connection diagrams show the wiring for two terminal blocks, CN1 and CN2, on the XW2B-20G5 module. Each diagram shows 16 channels (0-15) with terminals for +V, COM, and L. The diagrams illustrate how to connect the module to a power source (+V) and ground (GND) for each channel.</p> | |

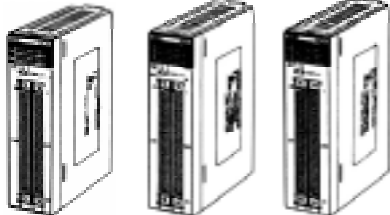
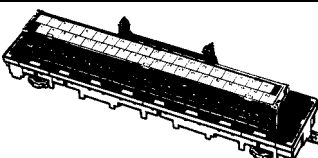
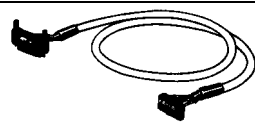

| Item | Mixed I/O (MD) | |
|--------------------|--|---|
| PLC I/O modules | <div style="display: flex; align-items: center;">  <div> <p>C200H-MD115 C200H-MD215 C200H-MD501 C500-MD211CN</p> <p>16-point input/16-point output mixed I/O modules use two blocks and two cables.</p> </div> </div> | |
| Terminal blocks | <div style="display: flex; align-items: center;">  <div> <p>XW2B-20G5 XW2B-20G4</p> </div> </div> | |
| Cable |  <p>XW2Z-□□□A</p> |  <p>G79-□C</p> |
| Connection diagram | <div style="display: flex; flex-wrap: wrap;"> <div style="width: 50%; text-align: center;"> <p>CN1</p> <p>XW2B-20G5</p>  </div> <div style="width: 50%; text-align: center;"> <p>CN1</p> <p>XW2B-20G5</p>  </div> <div style="width: 50%; text-align: center;"> <p>CN2</p> <p>XW2B-20G5</p>  </div> <div style="width: 50%; text-align: center;"> <p>CN2</p> <p>XW2B-20G5</p>  </div> </div> | |

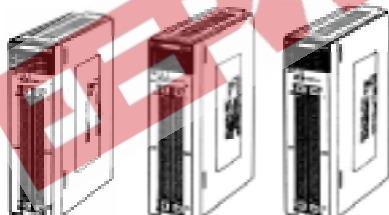
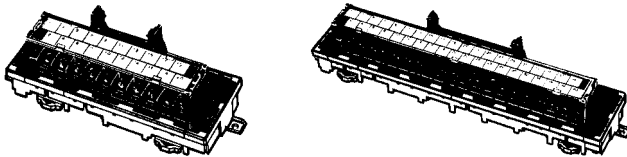
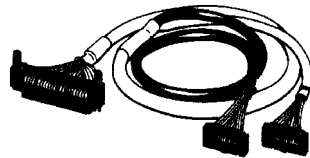
| Item | Group 2 High-density Input/Output | | | | | | | | | | | | | | | | | | | | | | | | | | | |
|--------------------|---|---|----------|---------------------------------------|-------------|----------|---------------------------------------|-------------|----------|---|-------------|----------|---|------------|----------|---|-------------|----------|---|------------|----------|---------------------------------------|-------------|----------|---------------------------------------|-------------|----------|---|
| PLC I/O module |  <table border="0"> <tr> <td>CQM1-ID213</td> <td>32-point</td> <td>Use one terminal block and one cable.</td> </tr> <tr> <td>C200H-ID216</td> <td>32-point</td> <td>Use one terminal block and one cable.</td> </tr> <tr> <td>C200H-ID111</td> <td>64-point</td> <td>Use two terminal blocks and two cables.</td> </tr> <tr> <td>C200H-ID217</td> <td>64-point</td> <td>Use two terminal blocks and two cables.</td> </tr> <tr> <td>C500-ID114</td> <td>64-point</td> <td>Use two terminal blocks and two cables.</td> </tr> <tr> <td>3G2A5-ID219</td> <td>64-point</td> <td>Use two terminal blocks and two cables.</td> </tr> <tr> <td>CQM1-OD213</td> <td>32-point</td> <td>Use one terminal block and one cable.</td> </tr> <tr> <td>C200H-OD218</td> <td>32-point</td> <td>Use one terminal block and one cable.</td> </tr> <tr> <td>C200H-OD219</td> <td>64-point</td> <td>Use two terminal blocks and two cables.</td> </tr> </table> | CQM1-ID213 | 32-point | Use one terminal block and one cable. | C200H-ID216 | 32-point | Use one terminal block and one cable. | C200H-ID111 | 64-point | Use two terminal blocks and two cables. | C200H-ID217 | 64-point | Use two terminal blocks and two cables. | C500-ID114 | 64-point | Use two terminal blocks and two cables. | 3G2A5-ID219 | 64-point | Use two terminal blocks and two cables. | CQM1-OD213 | 32-point | Use one terminal block and one cable. | C200H-OD218 | 32-point | Use one terminal block and one cable. | C200H-OD219 | 64-point | Use two terminal blocks and two cables. |
| CQM1-ID213 | 32-point | Use one terminal block and one cable. | | | | | | | | | | | | | | | | | | | | | | | | | | |
| C200H-ID216 | 32-point | Use one terminal block and one cable. | | | | | | | | | | | | | | | | | | | | | | | | | | |
| C200H-ID111 | 64-point | Use two terminal blocks and two cables. | | | | | | | | | | | | | | | | | | | | | | | | | | |
| C200H-ID217 | 64-point | Use two terminal blocks and two cables. | | | | | | | | | | | | | | | | | | | | | | | | | | |
| C500-ID114 | 64-point | Use two terminal blocks and two cables. | | | | | | | | | | | | | | | | | | | | | | | | | | |
| 3G2A5-ID219 | 64-point | Use two terminal blocks and two cables. | | | | | | | | | | | | | | | | | | | | | | | | | | |
| CQM1-OD213 | 32-point | Use one terminal block and one cable. | | | | | | | | | | | | | | | | | | | | | | | | | | |
| C200H-OD218 | 32-point | Use one terminal block and one cable. | | | | | | | | | | | | | | | | | | | | | | | | | | |
| C200H-OD219 | 64-point | Use two terminal blocks and two cables. | | | | | | | | | | | | | | | | | | | | | | | | | | |
| Terminal block |  <p>XW2B-40G5 XW2B-40G4</p> | | | | | | | | | | | | | | | | | | | | | | | | | | | |
| Cable |  <p>XW2Z-□□□B</p> | | | | | | | | | | | | | | | | | | | | | | | | | | | |
| Connection diagram |  <p>The diagram shows the XW2B-40G5 terminal block with 40 pins. The top half (pins 1-20) is labeled I(III) and the bottom half (pins 21-40) is labeled II(IV). Each side has a common (COM) terminal, normally closed (NC) terminals, and a power (+) terminal. The internal circuitry shows how these terminals are connected to the module's input/output points.</p> | | | | | | | | | | | | | | | | | | | | | | | | | | | |

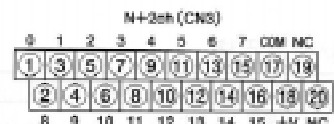
| Item | High-density I/O 1:1 Connection |
|----------------|--|
| PLC I/O module |  <p>CS1W-ID29□ CS1W-OD29□ CS1W-MD29□</p> <p>Use two terminal blocks and two cables.</p> |
| Terminal block |  <p>One XW2B-60G5 or one XW2B-60G4 per cable</p> |
| Cable |  <p>XW2Z-□□□H-1</p> |
| Connection | <p>XW2B-60G□</p>  |

| Item | High-density I/O 1:2 Connection |
|----------------|--|
| PLC I/O module |  <p>CS1W-ID29□ CS1W-OD29□ CS1W-MD29□</p> <p>Use two 40-point and two 20-point terminal blocks and two cables.</p> |
| Terminal block |  <p>XW2B-40G5 + XW2B-20G5 blocks or XW2B-40G4 + XW2B-20G4 blocks per cable</p> |
| Cable |  <p>XW2Z-□□□H-2</p> |
| Connection | <p>XW2B-40G□</p>  <p>XW2B-20G□</p>  |

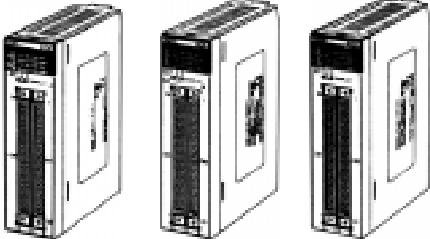
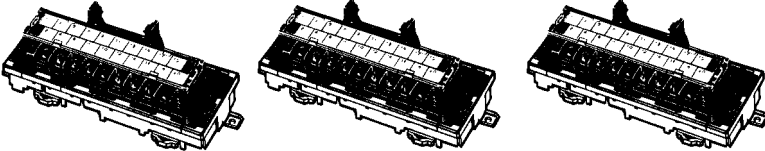
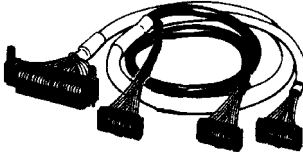
Note: For detailed information about connector pin-outs, refer to CS1 Operation Manual (W339), Appendix A.

| Item | High-density I/O 1:3 Connection |
|----------------|--|
| PLC I/O module |  <p data-bbox="994 389 1139 454">CS1W-ID29□ CS1W-OD29□ CS1W-MD29□</p> <p data-bbox="994 474 1326 517">Use six 20-point terminal blocks of the same kind and two cables.</p> |
| Terminal block |  <p data-bbox="1166 595 1445 660">Three XW2B-20G5 blocks or three XW2B-20G4 blocks per cable</p> |
| Cable |  <p data-bbox="1015 817 1177 842">XW2Z-□□□H-3</p> |
| Connection |  <p data-bbox="384 936 512 960">XW2B-20G□</p> <p data-bbox="735 936 863 960">XW2B-20G□</p> <p data-bbox="1078 936 1206 960">XW2B-20G□</p> |

Note: For detailed information about connector pin-outs, refer to CS1 Operation Manual (W339), Appendix A.

NOTE: DIMENSIONS SHOWN ARE IN MILLIMETERS. To convert millimeters to inches divide by 25.4.

OMRON[®]
OMRON ELECTRONICS, INC.
 One East Commerce Drive
 Schaumburg, IL 60173
1-800-55-OMRON

OMRON CANADA, INC.
 885 Milner Avenue
 Scarborough, Ontario M1B 5V8
416-286-6465