

Ultra High Precision Bulk Metal® Z-Foil Surface Mount Voltage Divider, TCR Tracking of < 0.1 ppm/°C, PCR of ± 5 ppm at Rated Power and Stability of ± 0.005 % (50 ppm)

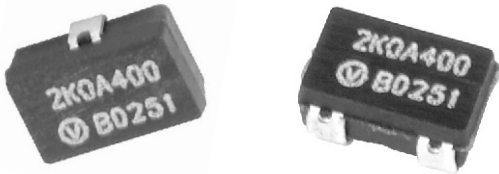

Any value at any ratio available within resistance range

INTRODUCTION

Bulk Metal® Z-Foil Technology out-performs all other resistor technologies available today for applications that require ultra-high precision and ultra-high stability.

The Z-Foil technology provides a significant reduction of the resistive element's sensitivity to ambient temperature variations (TCR) and to self heating when power is applied (power coefficient).

The DSMZ offers low TCR (both absolute and tracking), low PCR, excellent load life stability, tight tolerance match, excellent ratio stability, low thermal EMF, and low current noise - all in one package.

The DSMZ surface mount divider provides a matched pair of Bulk Metal® Z-Foil Resistors in a small epoxy molded package. The electrical specification of this integrated construction offers improved performance and better real estate utilization over discrete resistors and matched pairs.

Our Application Engineering Department is available to advise and make recommendations. For non-standard technical requirements and special applications, please contact us.

FEATURES

- Temperature Coefficient of Resistance (TCR): Absolute: ± 0.05 ppm/°C typical (0 °C to + 60 °C) ± 0.2 ppm/°C typical (- 55 °C to + 125 °C, + 25 °C Ref.) Tracking: 0.1 ppm/°C typical
- Power Coefficient Tracking "ΔR due to self heating": ± 5 ppm at Rated Power
- Power Rating at 70 °C: Entire Package: 0.1 W Each Resistor: 0.05 W
- Tolerance: Absolute: ± 0.02 %; Match: 0.01 %
- Ratio Stability: 0.005 % (0.05 W at 70 °C, 2000 hours)
- Resistance Range: 100 Ω to 10 kΩ per resistor
- Large Variety of Resistance Ratios: 1:100
- Electrostatic Discharge (ESD) above 25 000 V
- Short Time Overload ≤ 0.005 %
- Non Inductive, Non Capacitive Design
- Rise Time: 1.0 ns without ringing
- Current Noise: < - 40 dB
- Thermal EMF: 0.05 μV/°C typical
- Voltage Coefficient: < 0.1 ppm/V
- Non Inductive: < 0.08 μH
- Non Hot Spot Design
- Terminals: silver coated copper alloy
- For better performances, please contact Application Engineering



Available
RoHS*
COMPLIANT

TABLE 1 - RESISTANCE VALUES AND TOLERANCES¹⁾

RESISTANCE VALUES	100 Ω - 10 kΩ per resistor ²⁾
ABSOLUTE TOLERANCE EACH RESISTOR	± 0.02 %, ± 0.05 %, ± 0.1 %
RESISTANCE TOLERANCE MATCH	0.01 %, 0.02 %, 0.05 %
TCR	Absolute: (typical and maximum spread): ± 0.2 ± 2.0 ppm/°C Tracking: (maximum) For R1/R2 = 1 0.5 ppm/°C For 1 < R1/R2 ≤ 10 1.0 ppm/°C For 10 < R1/R2 ≤ 100 2.0 ppm/°C

Notes

1. Tighter performances are available
2. 100 Ω to 20 kΩ per resistor available in DSM

FIGURE 1 - SCHEMATIC

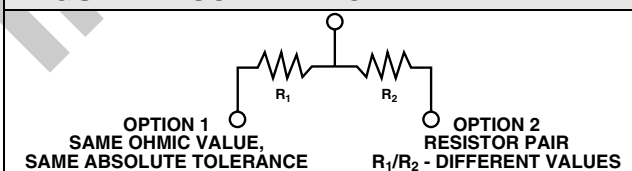

APPLICATIONS

- Instrumentation amplifiers
- Bridge networks
- Differential amplifiers
- Ratio arms in bridge circuits
- Medical and test equipment
- Military
- Airborne etc.

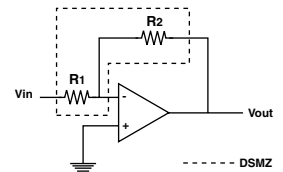
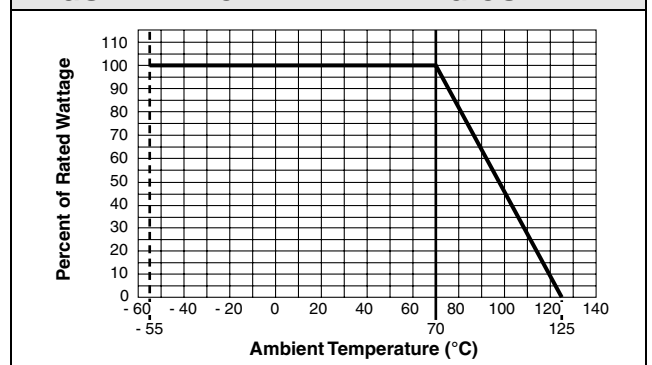

FIGURE 2 - POWER DERATING CURVE



* Pb containing terminations are not RoHS compliant, exemptions may apply

DSMZ (Z-Foil)



Vishay Foil Resistors Ultra High Precision Bulk Metal® Z-Foil Surface Mount Voltage Divider, TCR Tracking of $\leq 0.1 \text{ ppm}/^\circ\text{C}$, PCR of $\pm 5 \text{ ppm}$ at Rated Power and Stability of $\pm 0.005 \%$ (50 ppm)

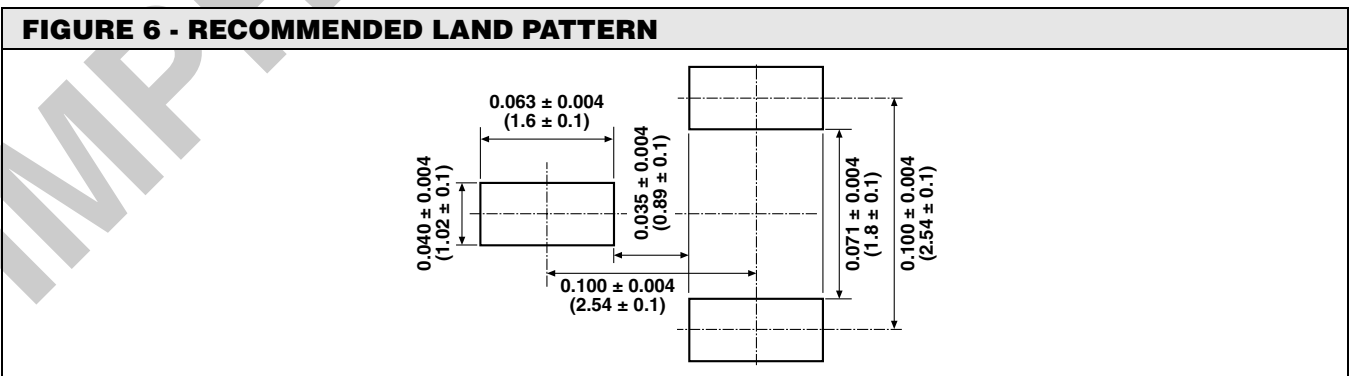
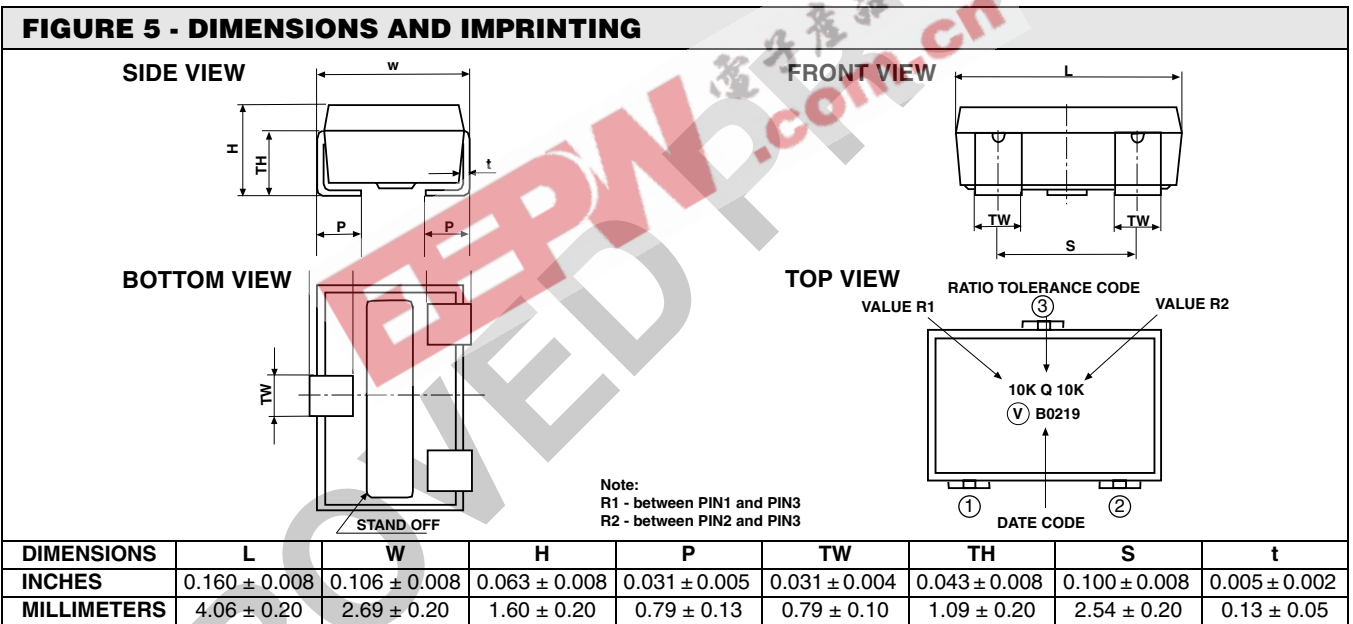
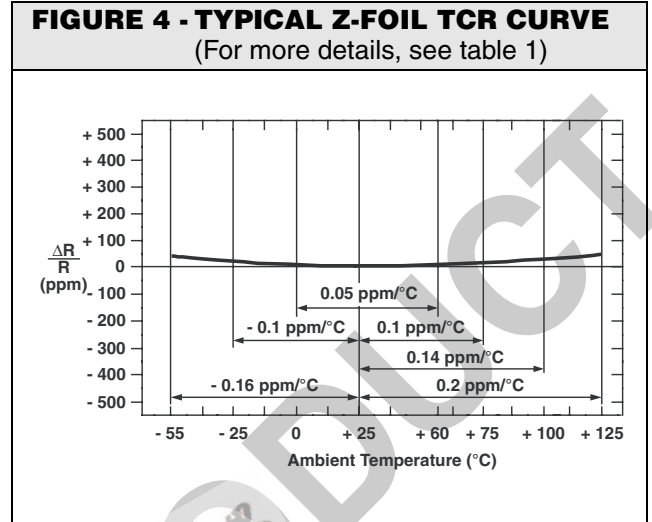
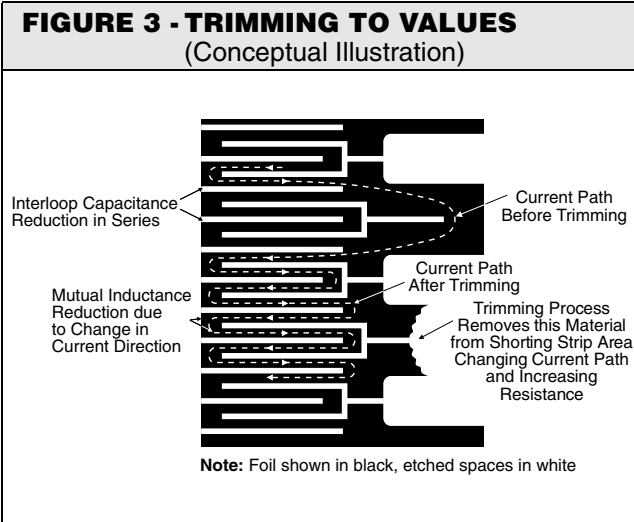



DSMZ (Z-Foil)

Ultra High Precision Bulk Metal[®] Z-Foil Surface Mount Vishay Foil Resistors
 Voltage Divider, TCR Tracking of $\leq 0.1 \text{ ppm}/^{\circ}\text{C}$, PCR of $\pm 5 \text{ ppm}$ at Rated Power and Stability of $\pm 0.005 \%$ (50 ppm)

TABLE 2 - PERFORMANCE SPECIFICATIONS (Test Method Per MIL-PRF-914)	
SPECIFICATIONS	TYPICAL LIMITS
Power rating at 70 °C	Entire package: 0.1 W Each resistor: 0.05 W
Maximum Working Voltage (each resistor)	25 V
Working Temperature Range	- 65 °C to + 125 °C
Thermal Shock 25 x (- 65 °C to + 125 °C)	$\Delta R = 0.01 \%$ (100 ppm) $\Delta \text{Ratio} = 0.005 \%$ (50 ppm)
Thermal Shock 5 x (- 65 °C to + 125 °C) and Power Conditioning 1.5 rated power at 25 °C, 100 hours	$\Delta R = 0.015 \%$ (150 ppm) $\Delta \text{Ratio} = 0.01 \%$ (100 ppm)
DWV atmospheric pressure, 200 V (A.C.), 1 minute	Successfully passed
Insulation Resistance 100 V (D.C.), 1 minute	$> 10^4 \text{ M}\Omega$
Resistance to Soldering Heat	$\Delta R = 0.01 \%$ (100 ppm) $\Delta \text{Ratio} = 0.005 \%$ (50 ppm)
Moisture Resistance + 65 °C to - 10 °C; 90 % to 98 % RH; 0.1 x rated power, 240 hours	$\Delta R = 0.02 \%$ (200 ppm) $\Delta \text{Ratio} = 0.005 \%$ (50 ppm)
Shock (Specified Pulse) 100 G	$\Delta R = 0.005 \%$ (50 ppm) $\Delta \text{Ratio} = 0.0025 \%$ (25 ppm)
Vibration, High Frequency (10 Hz - 2000 Hz), 20 G	$\Delta R = 0.01 \%$ (100 ppm) $\Delta \text{Ratio} = 0.005 \%$ (50 ppm)
High Temperature Exposure 100 hours at 125 °C	$\Delta R = 0.01 \%$ (100 ppm) $\Delta \text{Ratio} = 0.005 \%$ (50 ppm)
Low Temperature Storage 24 hours at - 65 °C	$\Delta R = 0.005 \%$ (50 ppm) $\Delta \text{Ratio} = 0.005 \%$ (50 ppm)
Load Life Stability 2000 hours at + 70 °C; rated power	$\Delta R = 0.005 \%$ (50 ppm) $\Delta \text{Ratio} = 0.005 \%$ (50 ppm)
Short Time Overload 6.25 x Rated Power; 5 seconds	$\Delta R = 0.005 \%$ (50 ppm) $\Delta \text{Ratio} = 0.0025 \%$ (25 ppm)
Low Temperature Operation	$\Delta R = 0.005 \%$ (50 ppm) $\Delta \text{Ratio} = 0.0025 \%$ (25 ppm)
Weight	0.04 g

DSMZ (Z-Foil)



Vishay Foil Resistors Ultra High Precision Bulk Metal® Z-Foil Surface Mount Voltage Divider, TCR Tracking of $\leq 0.1 \text{ ppm}/^\circ\text{C}$, PCR of $\pm 5 \text{ ppm}$ at Rated Power and Stability of $\pm 0.005 \%$ (50 ppm)

TABLE 3 - GLOBAL PART NUMBER INFORMATION

NEW GLOBAL PART NUMBER: Y4485V0067QT9W (preferred part number format)

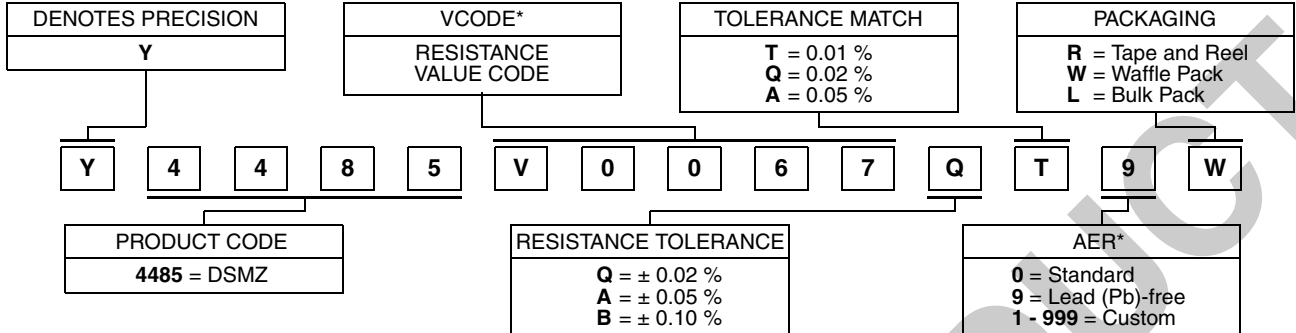

FOR EXAMPLE: ABOVE GLOBAL ORDER Y4485 V0067 Q T 9 W:

TYPE: DSMZ
VALUES: 10K/400R
ABSOLUTE TOLERANCE: $\pm 0.02 \%$
TOLERANCE MATCH: 0.01 %
TERMINATION: Lead (Pb)-free
PACKAGING: Waffle Pack

HISTORICAL PART NUMBER: DSMZ 10K 400R TCR0.2 Q T S W (will continue to be used)

DSMZ	10K 400R	TCR0.2	Q	T	S	W
MODEL	OHMIC VALUE R ₁ = 10 kΩ R ₂ = 400 Ω	TCR CHARACTERISTIC	ABSOLUTE TOLERANCE Q = $\pm 0.02 \%$ A = $\pm 0.05 \%$ B = $\pm 0.10 \%$	TOLERANCE MATCH T = 0.01 % Q = 0.02 % A = 0.05 %	TERMINATION S = Lead (Pb)-free B = Tin/Lead	PACKAGING T = Tape and Reel W = Waffle Pack B = Bulk Pack

Note

* For non-standard requests or additional values, please contact Application Engineering.

TABLE 4 - RESISTANCE VALUE CODE LIST FOR POPULAR RATIOS¹⁾

VCODES	R1/R2 RATIO	R1	R2	VCODES	R1/R2 RATIO	R1	R2	
V0052	100	10K	100R	V0080	2.5	1K	400R	
V0065	50	10K	200R	V0081		500R	200R	
V0066		5K	100R	V0082	2	10K	5K	
V0067	25	10K	400R	V0083		2K	1K	
V0068		5K	200R	V0084		1K	500R	
V0069	20	10K	500R	V0085		400R	200R	
V0070		2K	100R	V0086	200R	100R		
V0071	10	10K	1K	V0087	1.25	500R	400R	
V0072		2K	200R	V0001	1	10K	10K	
V0073		1K	100R			V0002	5K	5K
V0074		5	5K			1K	V0059	2K
V0075	2K		400R			V0004	1K	1K
V0076	1K		200R			V0091	500R	500R
V0077	500R		100R			V0090	400R	400R
V0246	4	10K	2K5			V0089	200R	200R
V0078		2K	500R			V0088	100R	100R
V0079		400R	100R					

Note

1. Other values available upon request.



Disclaimer

All product specifications and data are subject to change without notice.

Vishay Intertechnology, Inc., its affiliates, agents, and employees, and all persons acting on its or their behalf (collectively, "Vishay"), disclaim any and all liability for any errors, inaccuracies or incompleteness contained herein or in any other disclosure relating to any product.

Vishay disclaims any and all liability arising out of the use or application of any product described herein or of any information provided herein to the maximum extent permitted by law. The product specifications do not expand or otherwise modify Vishay's terms and conditions of purchase, including but not limited to the warranty expressed therein, which apply to these products.

No license, express or implied, by estoppel or otherwise, to any intellectual property rights is granted by this document or by any conduct of Vishay.

The products shown herein are not designed for use in medical, life-saving, or life-sustaining applications unless otherwise expressly indicated. Customers using or selling Vishay products not expressly indicated for use in such applications do so entirely at their own risk and agree to fully indemnify Vishay for any damages arising or resulting from such use or sale. Please contact authorized Vishay personnel to obtain written terms and conditions regarding products designed for such applications.

Product names and markings noted herein may be trademarks of their respective owners.