

## Description

The YB1211 is a low-noise, low dropout (LDO) linear regulator with enable function and external adjustable output voltage. It operates at an input supply of 2.0~6.0V and is able to output voltages ranging from 1.23V (The YB1211 internal reference voltage) to 5V by a feedback from a pair of resistor divider.

The YB1211 regulators are optimized to work with low-ESR and low cost ceramic capacitors, reducing the amount of board space critical in portable devices. The YB1211 requires only 1.0μF output capacitor for stability with a load up to 300mA and consumes less than 1μA in shutdown mode.

Built-in thermal shutdown and short-circuit protect offer secure protection against fault operation. The YB1211 regulators are available in a small SOT-25 package.

## Features

- 1.235V Internal Reference Voltage
- Adjustable Output Voltage : 1.22~5.0V
- Low-Noise and Low-Drop-Out
- Typical Output Current : 300mA
- Low Quiescent Current: ~60μA
- 320mV Dropout at 300mA 3.3V Output
- Stable with 1.0μF Ceramic Capacitor
- Only Need Input and Output Capacitors
- Thermal Protection Shutdown
- Output Short-Circuit Current Limit
- Built-In Internal Soft-Start
- Green Package (RoHS) Available

## Applications

- PDA, Notebook, PC Computers
- DSC, Handset Camera Modules
- PCMCIA Cards, PC Cameras
- USB Based Portable Devices
- GSM/GPRS/3G RF Transceiver
- Wireless LANs
- Bluetooth Portable Radios
- Battery-Powered Devices

## Typical Application Circuitry

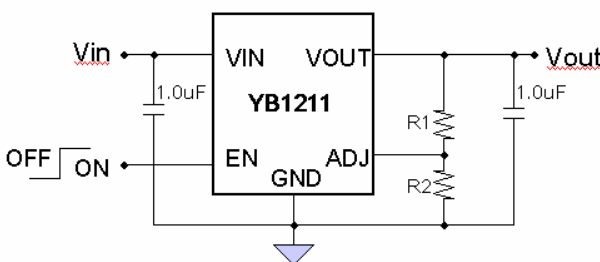

Figure 1-1 : Typical Application Circuit

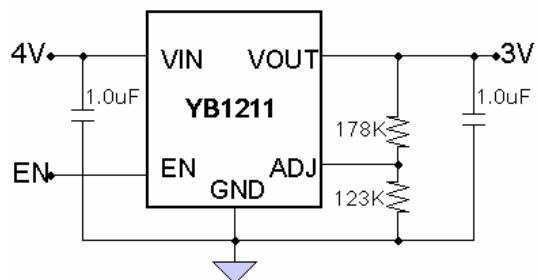

Figure 1-2 : A 3V Output Example

### Pin Configuration

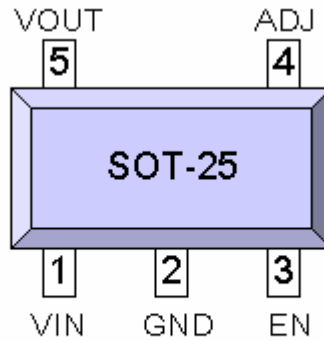

Figure 2 : Pin Configuration

### Pin Description

Table 1

Pin Name	Pin Function
VIN	Unregulated Input Supply. Bypass with a capacitor to GND.
GND	Ground pin.
EN	Chip enable, pull high to enable the regulator.
ADJ	Adjustable feedback voltage. The output voltage is set by the external pair of resistors R1 and R2 and the output voltage is calculated by : $V_{OUT} = 1.235 * (1 + R1/R2)$ Volts
VOUT	Regulated Output Voltage. Bypass with a capacitor to GND.

**Ordering Information**

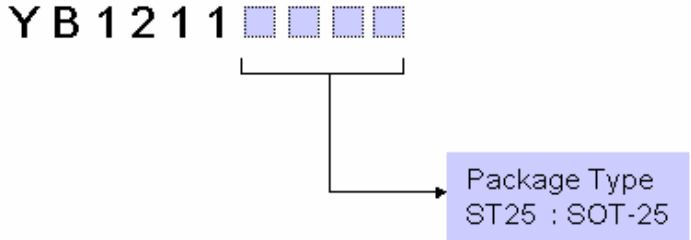

- Order example :  
 YB1211ST25 for YB1211 of SOT-25 package
- Shipping Quantity :  
 SOT-25 : 3000 units tape & reel
- Only green package

**Marking Information**

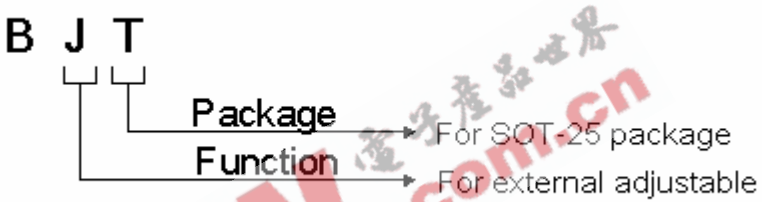

**Absolute Maximum Ratings**

Supply Voltage .....	-0.3V to 7.0V
Output Voltage .....	-0.3V to (V <sub>IN</sub> +0.3V)
Output Short-Circuit Duration .....	Infinite
Junction Temperature Range .....	+150°C
Storage Temperature Range .....	-65°C to +150°C
Lead Temperature .....	+250°C

**Recommended Operating Conditions**

Input Supply Voltage.....	2V to 6.0V
Operating Temperature.....	-40°C to +85°C
ESD Susceptibility (HBM).....	2KV
ESD Susceptibility (MM).....	200V

**Thermal Information**

Thermal Resistance of Junction to Case (SOT-25, $\theta_{JC}$ ) .....	140 °C/W
Thermal Resistance of Junction to Ambient (SOT-25, $\theta_{JA}$ ) .....	280 °C/W
Internal Power Dissipation (SOT-25, P <sub>D</sub> ) .....	400mW

### Electrical Characteristics

**Table 2**

$T_A = 25^{\circ}\text{C}$ ,  $V_{IN} = (V_{OUT} + 1\text{V})$ ,  $C_{IN} = C_{OUT} = 1.0\mu\text{F}$ ,  $V_{EN} = V_{IN}$ , unless otherwise noted

Function Parameter	Conditions	Min	Typ	Max	Units
Input Voltage Range		2.0		6.0	V
Output Voltage	External adjustable	1.235		5.0	V
Internal Reference Voltage	$I_{OUT} = 10\text{mA}$	1.210	1.235	1.260	V
Output Current Limit	Short-circuit output		300		mA
Dropout Voltage (Note 1)	$V_{out} = 5.0\text{V}$ , $I_{out} = 300\text{mA}$		250		mV
	$V_{out} = 3.0\text{V}$ , $I_{out} = 300\text{mA}$		350		
	$V_{out} = 2.0\text{V}$ , $I_{out} = 300\text{mA}$		480		
	$V_{out} = 1.5\text{V}$ , $I_{out} = 300\text{mA}$		700		
	$V_{out} = 1.2\text{V}$ , $I_{out} = 300\text{mA}$		850		
Ground Current	$I_{ground} = I_{in} - I_{out}$		60		$\mu\text{A}$
Line Regulation	$V_{in} = (V_{out} + 1\text{V})$ to 6V, $I_{out} = 10\text{mA}$		0.42		%/V
Load Regulation	$I_{out} = 1\text{mA}$ to 300 mA		1.0		%
Shutdown Supply Current	$EN = 0.4\text{V}$		0.01		$\mu\text{A}$
Ripple Rejection (PSRR)	$f = 1\text{KHz}$ , $I_{out} = 1\text{mA}$		50		dB
	$f = 10\text{KHz}$ , $I_{out} = 1\text{mA}$		45		
	$f = 100\text{KHz}$ , $I_{out} = 1\text{mA}$		27		
Start Up Delay (Note 2)	$R_{load} = 100\text{ohm}$		20	50	$\mu\text{S}$
EN Logic Low Level	$V_{in} = 2.0\text{V}$ to 6.0V			0.4	V
EN Logic High Level	$V_{in} = 2.0\text{V}$ to 6.0 V	1.2		$V_{in}$	V
EN Input Bias Current	$V_{in} = EN = V_{out} + 1\text{V}$		0.01		$\mu\text{A}$
Thermal Shutdown	Shutdown Temperature		160		$^{\circ}\text{C}$
Thermal Hysteresis			20		$^{\circ}\text{C}$

**Note 1 :** The drop out voltage varies depending on output voltage selection. Dropout is defined as  $V_{IN} - V_{OUT}$  when  $V_{OUT}$  is 100mV below  $V_{OUT}$  where  $V_{in} = V_{out} + 1\text{V}$  for nominal  $V_{OUT}$ .

**Note 2:** Time needed for  $V_{OUT}$  to reach 90% of final value.

## Typical Characteristics

At  $T_A=25^\circ\text{C}$ ,  $V_{IN}=(V_{OUT}+1\text{V})$ ,  $C_{IN}=C_{OUT}=1.0\mu\text{F}$ ,  $V_{EN}=V_{IN}$ , unless otherwise noted.

**Dropout Voltage vs Output Load**

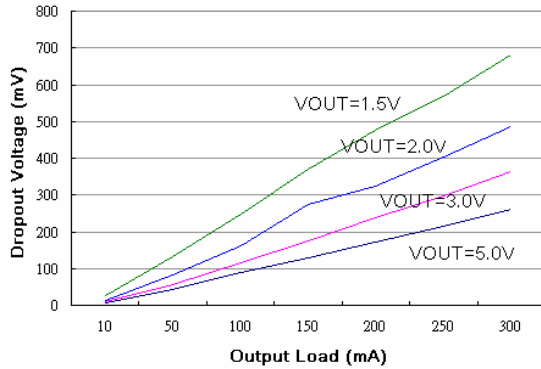

**Ground Current vs Input Voltage**

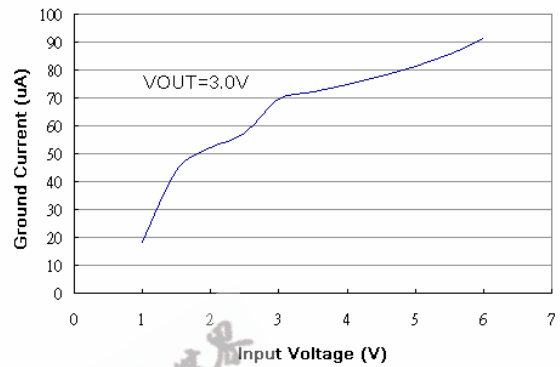

**Dropout Voltage vs Temperature**

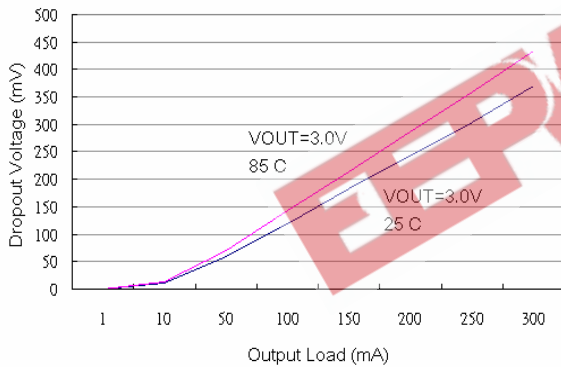

**Dropout Voltage vs Temperature**

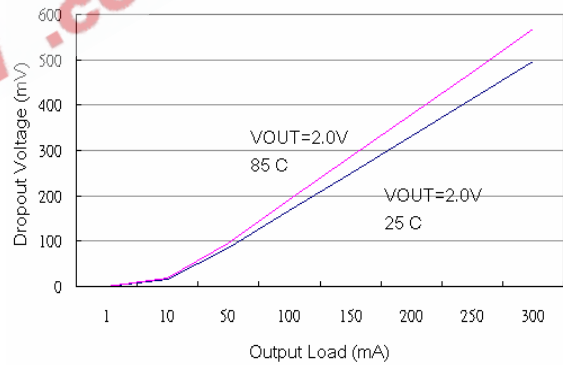

**Output Voltage vs Temperature**

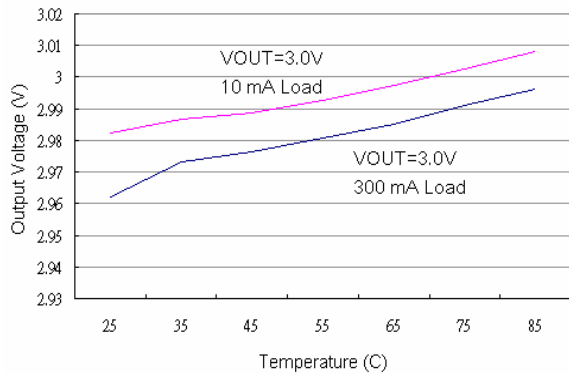

**Output Voltage vs Temperature**

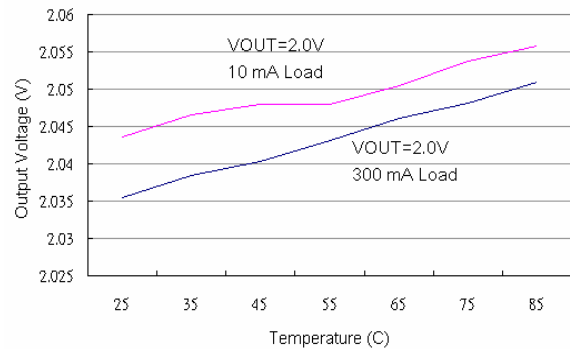

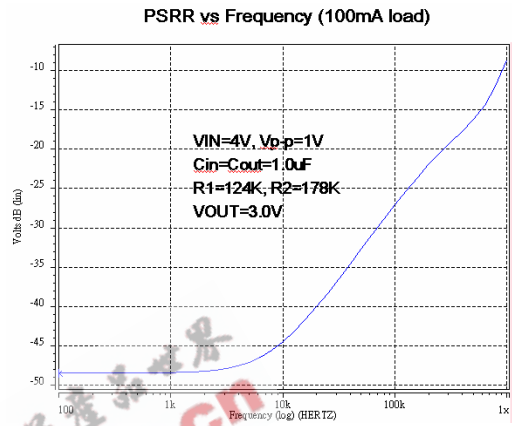
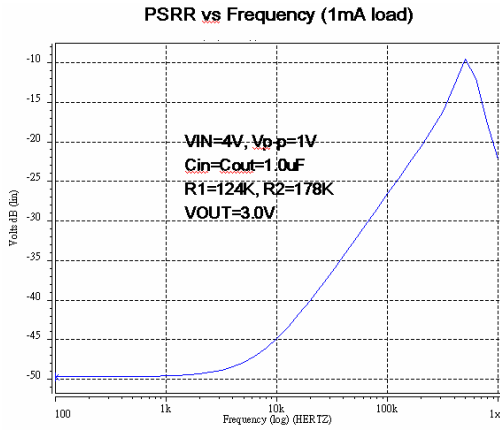

Line Transient Response

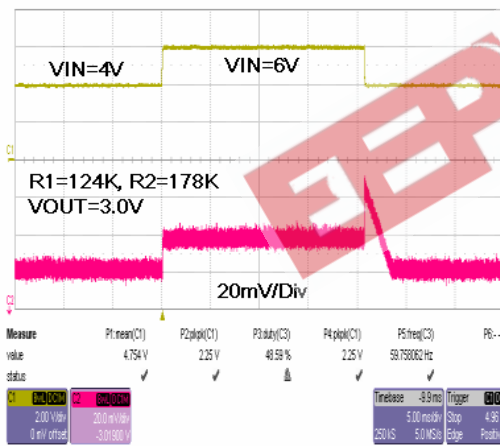

Load Transient Response

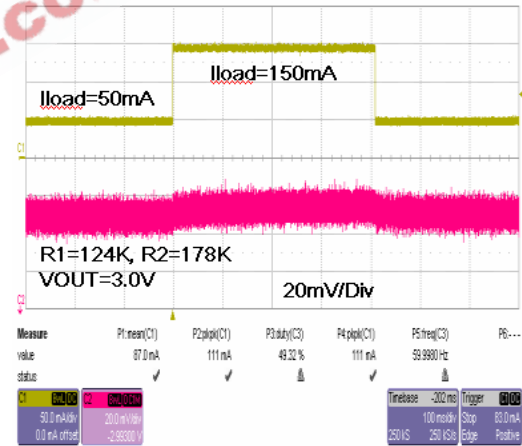

**Functional Block Diagram**

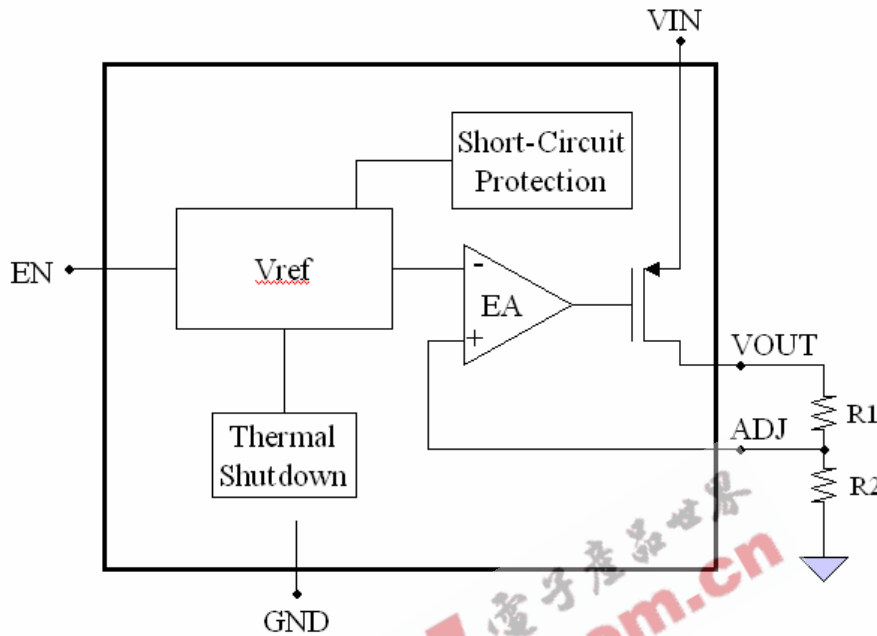

Figure 3 : Function Diagram

**Functional Description**

The YB1211 is an low-noise, low-quiescent current, low-dropout linear regulator. It is supplied in a small SOT-25 package for different applications. YB1211 can supply loads up to 300mA (typical operation, not maximum) and the output voltage are adjustable by a pair of resistor net (R1 and R2 in Figure 3), ranging from 1.22V to 5.0V.

As shown in the *Functional Block Diagram*, the YB1211 consists of a reference and an error amplifier, a big output drive transistor, thermal sensor, and short circuit current limiter. The feedback voltage is acquired from the external voltage divider through pin ADJ.

The internal reference is connected to the error amplifier's inverting input. The error amplifier compares this reference with the feedback voltage and amplifies the

difference. If the feedback voltage is lower than the reference voltage, the gate of the pass-transistor is pulled low. This allows more current to pass to the output and increases the output voltage. If the feedback voltage is too high, the gate of the pass transistor is pulled high, allowing less current to pass to the output.

**Stability**

The YB1211 is a high performance LDO emphasizing stability with low output capacitance. It is able to maintain stability with an output capacitor as low as 1.0 uF. The output capacitor can also be increased to optimize performance. The YB1211 will remain stable and in regulation with no load, unlike many other voltage regulators.

**Internal P-Channel Pass Transistor**

The YB1211 features a low impedance P-channel MOSFET pass transistor. This provides several advantages over similar designs using a PNP pass transistor, including low operating power and longer battery life. The YB1211 consumes only 60µA of quiescent current under most conditions.

### Output Short-Circuit Current Limit

The YB1211 includes a current limiter, which monitors and controls the pass transistor's gate voltage, limiting the output current to about 200mA, for example, in a short-circuit output situation.

### Shutdown

The YB1211 also features a low-power active shutdown mode. It has a switch that turns off the device when disabled. This allows the output capacitor and load to discharge and de-energize the load. In the shutdown mode, the internal functional blocks, such as voltage reference and the error amplifier, are turned off completely, and the quiescent current is less than 1µA.

### Thermal Protection Shutdown

The thermal protection shutdown function protects the device from operating in over temperature condition. When the junction temperature exceeds +160°C, the thermal sensor signals the shutdown logic, turning off the pass transistor and allowing the IC to cool down. The thermal sensor turns the pass transistor on again after the IC's junction temperature drops to +140°C.

### Soft-Start Circuitry

The YB1211 includes a soft-start circuitry to limit inrush current at turn-on. During power up, the output capacitor and output load are charged with a reduced output current. Shortly after the initial power up, the

soft-start feature is terminated and normal operation is resumed.

## Application Information

### Enable/Shutdown

The YB1211 comes with an active-high enable pin that allows the regulator to be enabled. Forcing the enable pin low disables the regulator and puts it into the shutdown mode. This pin cannot be left floating as it may cause an undetermined state.

### Input/Output Capacitor

It is recommended to use a 1.0µF capacitor on the YB1211 input and a 1.0µF capacitor on the output. For high regulation performance, larger input capacitor values and lower ESRs provide better noise rejection and line-transient response. The output noise, load-transient response, stability, and power-supply rejection can be improved by using large output capacitors. Low ESR ceramic capacitors provide optimal performance and save space.

### Low Output Voltage Application

For low output voltage of 1.5V below, YB1211 might show slight oscillation under 50mA loading. In order to stabilize YB1211 output voltage, it is recommended to add a 0.1µF capacitor between VOUT pin and ADJ pin as demonstrated as below :

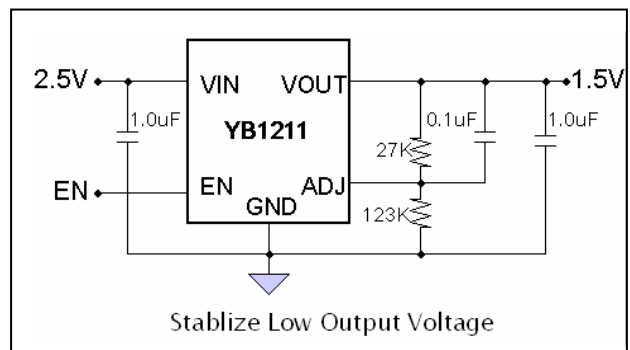



**SOT-25 Package Information**

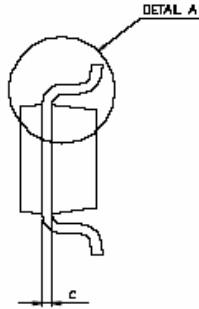
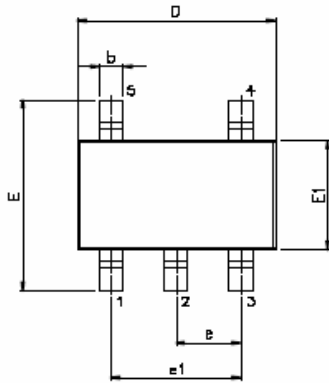

VARIATION (ALL DIMENSIONS SHOWN IN MM)

SYMBOL	MIN.	NOM.	MAX.
A	1.05	1.20	1.35
A1	0.05	0.10	0.15
A2	1.00	1.10	1.20
b	0.25	-	0.50
c	0.08	-	0.20
D	2.70	2.90	3.00
E	2.50	2.80	3.00
E1	1.50	1.80	1.70
e	0.95 BSC.		
e1	1.80 BSC.		
L	0.30	0.46	0.55
L1	0.60 REF.		
L2	0.25 BSC.		
Ø	Ø	5'	10'
Ø1	3'	5'	7'
Ø2	Ø'	8'	10'

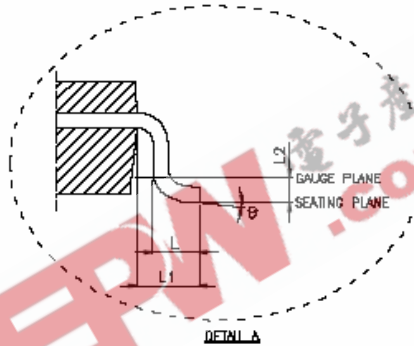
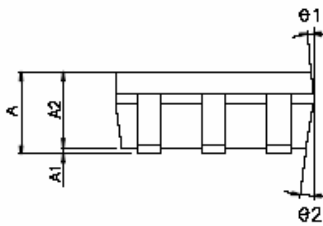

NOTE: 1. JEDEC OUTLINE : MO-17B AA