

Super LLD (For PFC circuit) (current continuous mode)

LOW LOSS SUPER HIGH SPEED RECTIFIER

Features

- Super high speed switching
- High reliability by planer design

Applications

- PFC circuit (current continuous mode)

Maximum ratings and characteristics

- Maximum ratings

Item	Symbol	Conditions	Rating	Unit
Repetitive peak reverse voltage	V_{RRM}		600	V
Non-Repetitive peak reverse voltage	V_{RSM}		600	V
Peak forward current	I_P		15	A
Average output current	I_o	Square wave duty=1/2, $T_c=123^\circ\text{C}$	5	A
Non-Repetitive surge current	I_{FSM}	Sine wave 10ms, 1shot	40	A
Operating junction temperature	T_j		150	$^\circ\text{C}$
Storage temperature	T_{stg}		-40 to +150	$^\circ\text{C}$

* Out put current of centertap full wave connection.

- Electrical characteristics ($T_a=25^\circ\text{C}$ Unless otherwise specified)

Item	Symbol	Conditions	Characteristics	Unit
Reverse recovery peak current **	I_{RP}	$I_F=5\text{A}, -di/dt=200\text{A}/\mu\text{s}, V_R=380\text{V } T_j=100^\circ\text{C}$	Typ. 2.5	A
Reverse recovery time **	t_{rr}	$I_F=0.1\text{A}, I_R=0.2\text{A}, I_{rec}=0.05\text{A}$	Max. 30.0	ns
Forward voltage **	V_F	$I_F=15\text{A}$	Max. 5.0	V
Reverse current **	I_R	$V_R=V_{RRM}$	Max. 50.0	μA
Thermal resistance	$R_{th(j-c)}$	Junction to case	Max. 2.0	$^\circ\text{C}/\text{W}$

** Rating per element

- Mechanical characteristics

Mounting torque	Recommended torque	0.3 to 0.5	N·m
Approximate mass		2.0	g

Outline drawings, mm

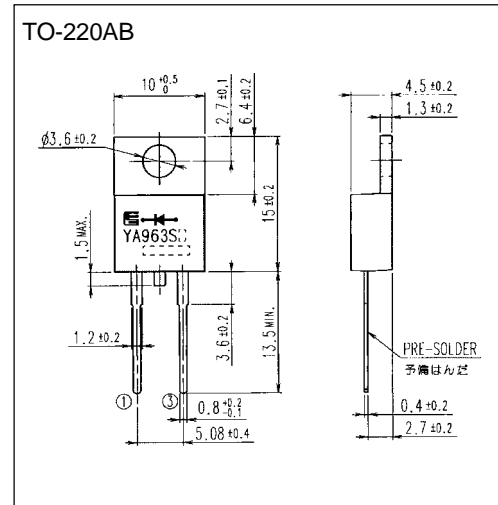

Connection diagram

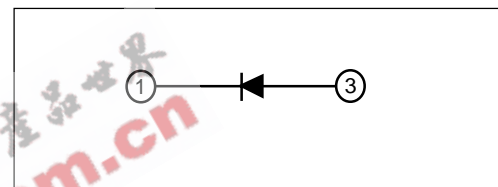

Characteristics

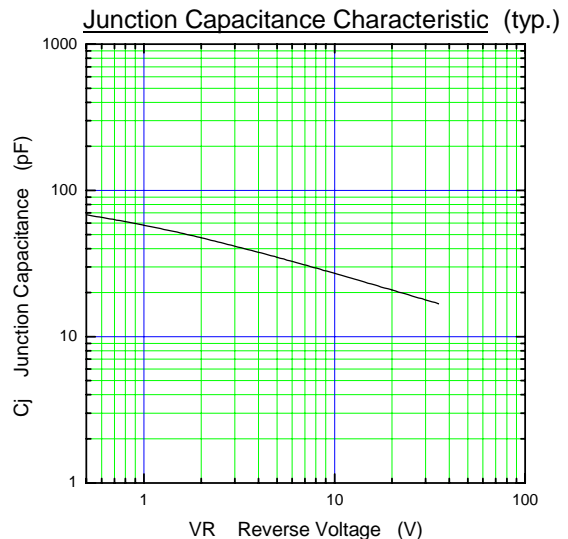
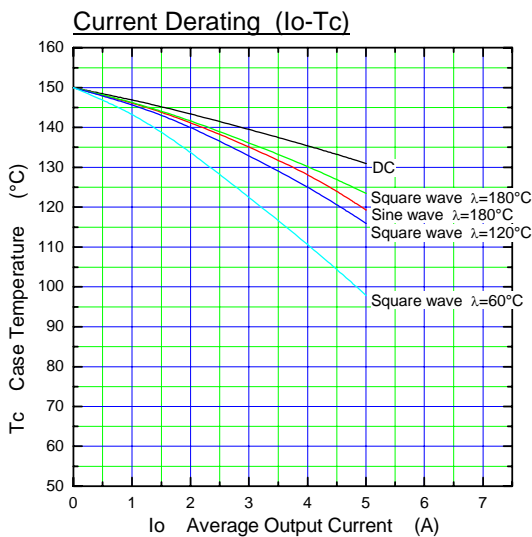
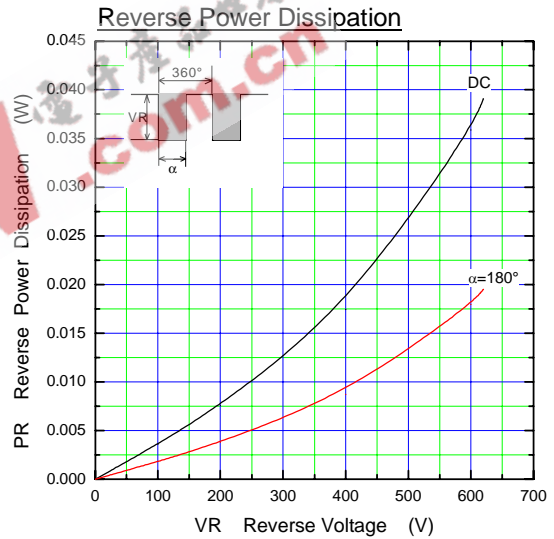
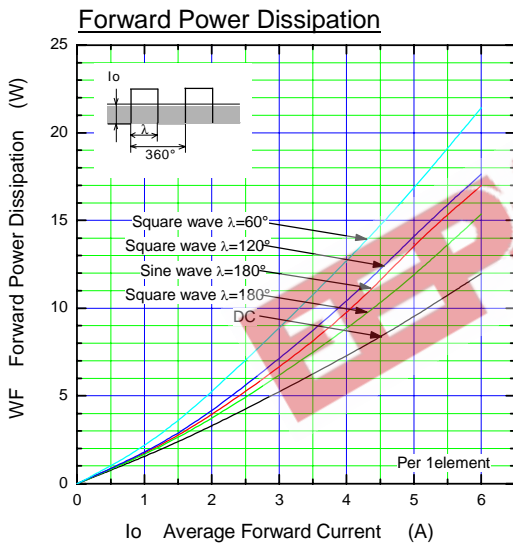
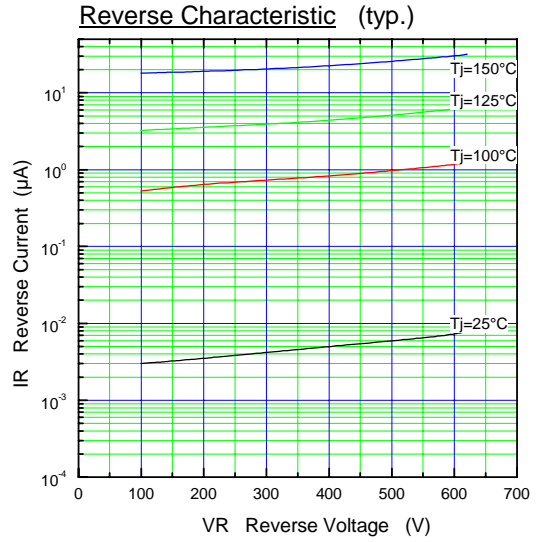
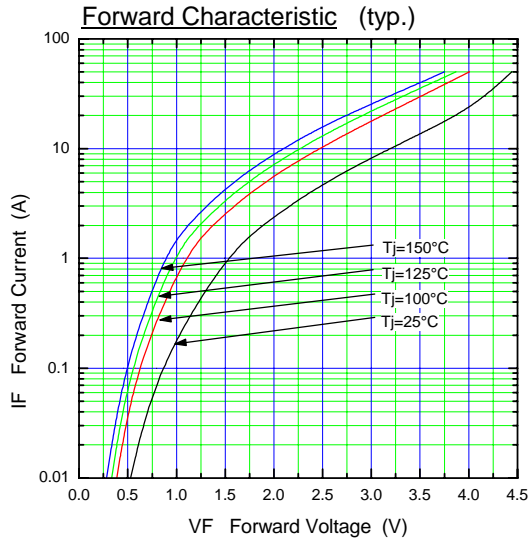

λ : Conduction angle of forward current for each rectifier element
 I_o : Output current of center-tap full wave connection

