

## Super LLD (For PFC circuit) (current continuous mode)

### LOW LOSS SUPER HIGH SPEED RECTIFIER

#### Features

- Super high speed switching
- High reliability by planer design

#### Applications

- PFC circuit (current continuous mode)

#### Maximum ratings and characteristics

- Maximum ratings

Item	Symbol	Conditions	Rating	Unit
Repetitive peak reverse voltage	$V_{RRM}$		600	V
Non-Repetitive peak reverse voltage	$V_{RSM}$		600	V
Peak forward current	$I_P$		8	A
Average output current	$I_o$	Square wave duty=1/2, $T_c=108^\circ\text{C}$	2.5	A
Non-Repetitive surge current	$I_{FSM}$	Sine wave 10ms, 1shot	15	A
Operating junction temperature	$T_j$		150	$^\circ\text{C}$
Storage temperature	$T_{stg}$		-40 to +150	$^\circ\text{C}$

\* Out put current of centertap full wave connection.

- Electrical characteristics ( $T_a=25^\circ\text{C}$  Unless otherwise specified)

Item	Symbol	Conditions	Characteristics	Unit
Reverse recovery peak current **	$I_{RP}$	$I_F=5\text{A}, -di/dt=200\text{A}/\mu\text{s}, V_R=380\text{V}$ $T_j=100^\circ\text{C}$	Typ. 1.9	A
Reverse recovery time **	$t_{rr}$	$I_F=0.1\text{A}, I_R=0.2\text{A}, I_{rec}=0.05\text{A}$	Max. 23.0	ns
Forward voltage **	$V_F$	$I_F=8\text{A}$	Max. 5.0	V
Reverse current **	$I_R$	$V_R=V_{RRM}$	Max. 50.0	$\mu\text{A}$
Thermal resistance	$R_{th(j-c)}$	Junction to case	Max. 6.0	$^\circ\text{C}/\text{W}$

\*\* Rating per element

- Mechanical characteristics

Mounting torque	Recommended torque	0.3 to 0.5	N·m
Approximate mass		2.0	g

#### Outline drawings, mm

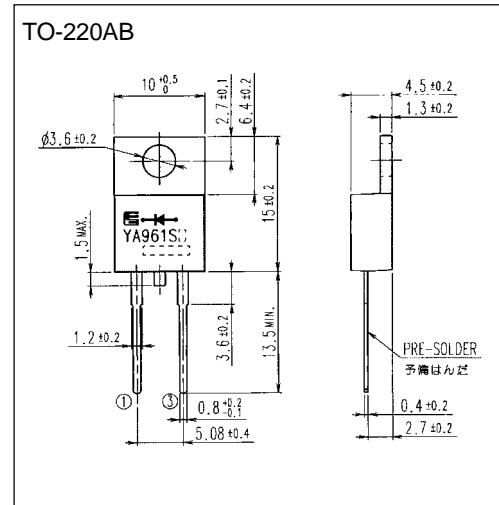

#### Connection diagram

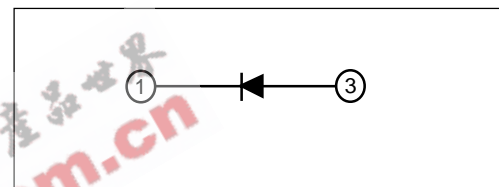

■ Characteristics

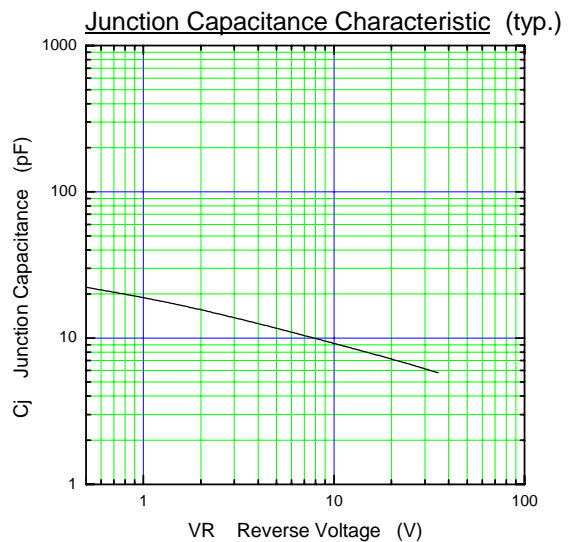
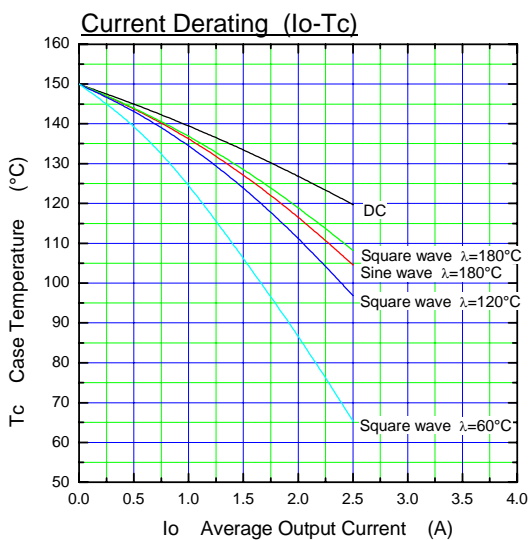
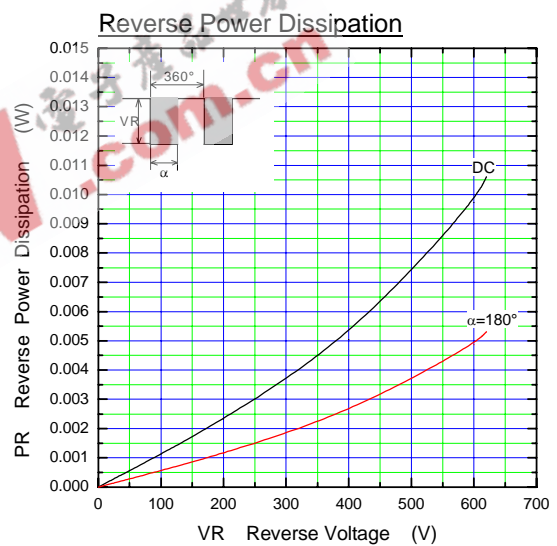
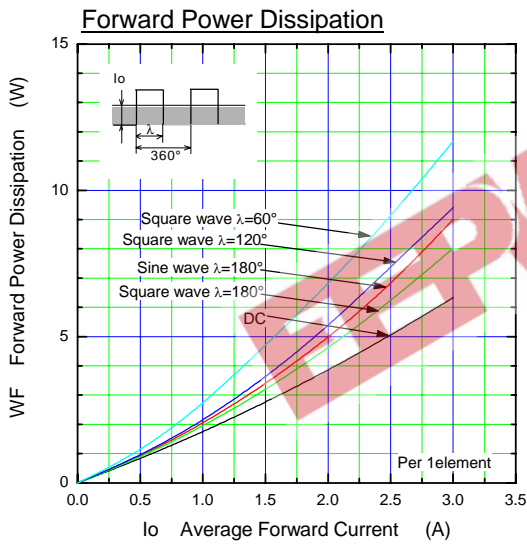
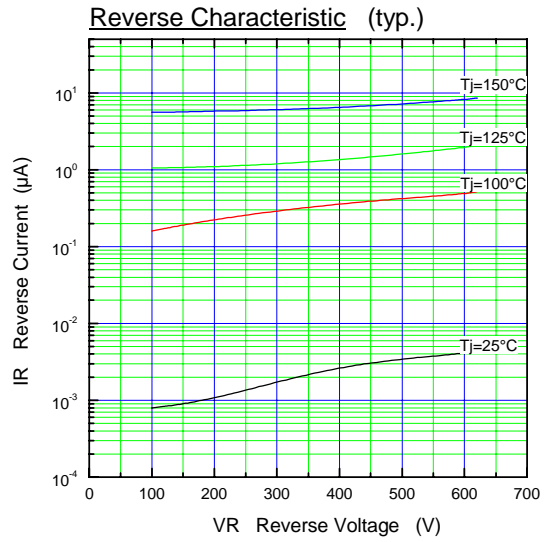
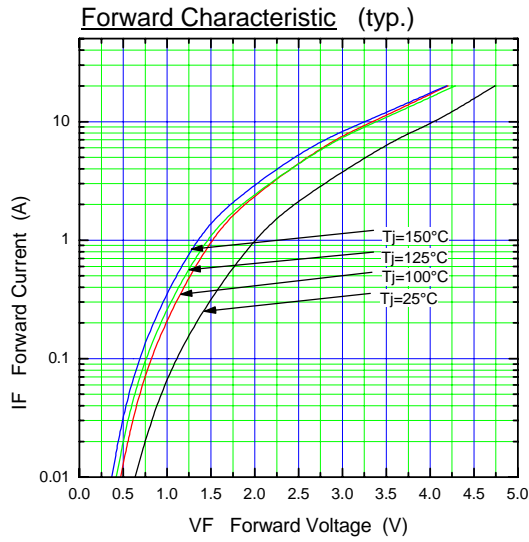

λ: Conduction angle of forward current for each rectifier element  
Io: Output current of center-tap full wave connection

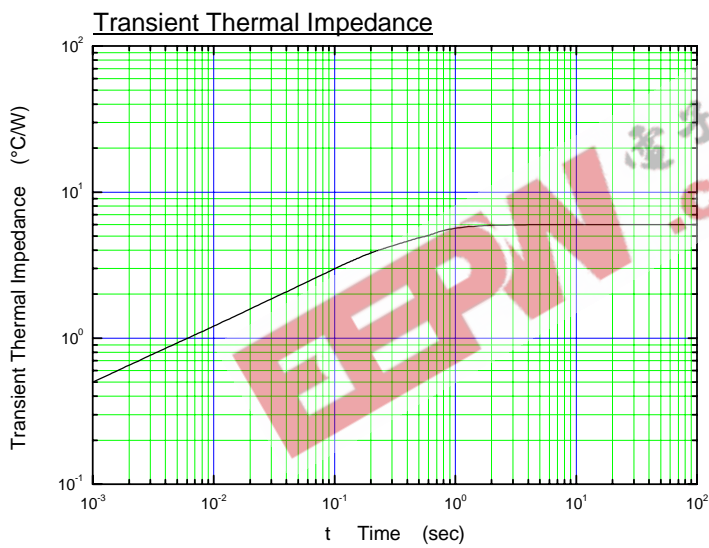
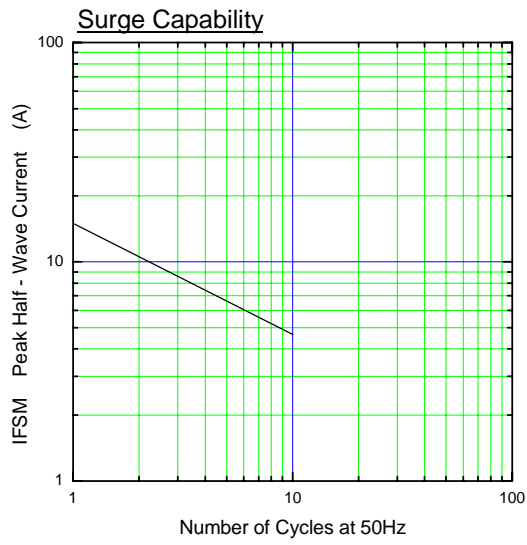

电子产品世界  
www.fujiel.com.cn