

SPECIFICATION

Device Name : SILICON DIODE

Type Name : YG963S6R

Spec.No. : MS5D1437

EEPW.com.cn 电子產品世界

This material and the information herein is the property of Fuji Electric Co., Ltd. They shall be neither reproduced, copied, lent, or disclosed in any way whatsoever for the use of any third party nor used for the manufacturing purposes without the express written consent of Fuji Electric Co., Ltd.

Fuji Electric Co.,Ltd.
Matsumoto Factory

	DATE	NAME	APPROVED	Fu ji Electric Co.,Ltd.	
DRAWN	Jan. -24- '02	<i>Kobayashi</i>	<i>H. Shi</i>	DWG. NO.	MS5D1437 1/12
CHECKED	Jan. -24- '02	<i>T. MOSE</i>			
	Jan. -24- '02	<i>m. wakasa</i>			

1. SCOPE

This specification provides the ratings and the test requirement for FUJI SILICON DIODE YG963S6R

2. Application

PFC circuit(current continuous mode)

This diode is a product which optimizes the diode characteristic for the PFC circuit. This product is a product by which the trr characteristic was valued more than VF though there is a relation of the trade-off up to VF and Trr. The total loss of the PFC circuit can be suppressed by shortening trr.

3. OUT VIEW, MARKING, MOLDING RESIN, CHARACTERISTICS

- (1) Out view is shown MS5D1437 9/12
(2) Marking is shown MS5D1437 9/12
It is marked to type name or abbreviated type name, polarity and Lot No.
(3) Molding resin
Epoxy resin UL:V-0
(4) Characteristics is shown MS5D1437 10/12~12/12

4. RATINGS

4.1 MAXIMUM RATINGS

ITEM	SYMBOL	CONDITIONS	RATINGS	UNITS
Repetitive peak reverse voltage	V _{RRM}		600	V
Non-repetitive peak reverse voltage	V _{RSM}		600	V
Isolating voltage	V _{iso}	Terminals-to-Case, AC, 1min	1500	V
Surge peak forward current	I _{ps}	tw = 200ns	20	A
Peak forward current	I _p		15	A
Average output current	I _o	Square wave duty =1/2 T _c = 103	5	A
Non-repetitive surge current	I _{FSM}	Sine wave, 10ms	40	A
Operating junction temperature	T _j		150	°C
Storage temperature	T _{stg}		-40~ + 150	°C

4.2 ELECTRICAL CHARACTERISTICS (at Ta=25 unless otherwise specified.)

ITEM	SYMBOL	CONDITIONS	MAXIMUM	UNITS
Reverse recovery peak current	I _{RP}	I _F =5A, -di/dt=200A/μs, V _R =380V T _j =100	Typ. 2.5	A
Reverse recovery time	trr	I _F =0.1A, I _R =0.2, I _{rec} =0.05A	Max. 30.0	ns
Forward voltage	V _F	I _F = 15 A	Max. 5.0	V
Reverse current	I _R	V _R = V _{RRM}	Max. 50.0	μA
Thermal resistance	R _{th(j-c)}	Junction to case	Max. 3.5	°C/W

4.3 MECHANICAL CHARACTERISTICS

Mounting torque	Recommended torque	0.3 ~ 0.5	N·m
Approximate mass		2.0	g

Fuji Electric Co.,Ltd.

DWG. NO.

MS5D1437 3/12

This material and the information herein is the property of Fuji Electric Co., Ltd. They shall be neither reproduced, copied, lent, or disclosed in any way whatsoever for the use of any third party nor used for the manufacturing purposes without the express written consent of Fuji Electric Co., Ltd.

5.TEST

	Test No.	Test Items	Testing methods and Conditions	Reference Standard EIAJ ED4701	Sampling number	Acceptance number
Mechanical test	1	Terminal Strength (Tensile)	Pull force TO-220,TO-220F : 10N TO-3P,TO-3PF,TO-247 : 25N TO-3PL : 45N T-Pack,K-Pack : 10N Force maintaining duration :30±1s	A-111A method 1	5	(0:1)
	2	Terminal Strength (Bending)	Load force TO-220,TO-220F : 5N TO-3P,TO-3PF,TO-247 : 10N TO-3PL : 15N T-Pack,K-Pack : 5N Number of times :2times(90deg./time)	A-111A method 3	5	
	3	Mounting Strength	Screwing torque value: (M3) TO-220,TO-220F : 40±10N TO-3P,TO-3PF,TO-247 : 50±10N TO-3PL : 70±10N	A-112 method 2	5	
	4	Vibration	frequency : 100Hz to 2kHz Acceleration : 100m/s ² Sweeping time : 4min./1 cycle 4times for each X,Y&Z directions.	A-121	5	
	5	Shock	Peak amplitude: 15km/s ² Duration time : 0.5ms 3times for each X,Y&Z directions.	A-122 test code D	5	
	6	Solderability	Solder temp. : 235±5°C Immersion time : 5±0.5s Each terminal shall be immersed in the solder bath within 1 to 3.0mm from the body.	A-131A test code A	5	
	7	Resistance to Soldering Heat	Solder temp. : 260±5°C Immersion time : 10±1s Number of times : 1times	A-132	5	

This material and the information herein is the property of Fuji Electric Co., Ltd. They shall be neither reproduced, copied, lent, or disclosed in any way whatsoever for the use of any third party nor used for the manufacturing purposes without the express written consent of Fuji Electric Co., Ltd.

Test No.	Test Items	Testing methods and Conditions	Reference Standard EIAJ ED4701	Sampling number	Acceptance number
Endurance test	1	High Temp. Storage	Temperature : Tstg max Test duration : 1000h	B-111A	22
	2	Low Temp. Storage	Temperature : Tstg min Test duration : 1000h	B-112A	22
	3	Temperature Humidity Storage	Temperature : 85±2°C Relative humidity : 85±5% Test duration : 1000h	B-121A test code C	22
	4	Temperature Humidity Bias	Temperature : 85±2°C Relative humidity : 85±5% Bias Voltage : $V_{RRM} \times 0.8$ Test duration : 1000h	B-122A test code C	22
	5	Unsaturated Pressurized Vapor	Temperature : 120±2°C Relative humidity : 85±5% Vapor pressure : 170kPa Test duration : 96h	B-123A test code B	22
	6	Temperature Cycle	High temp.side : Tstg max Room temp. : 5 ~ 35 Low temp.side : Tstg min Duration time : HT 30min, RT 5min LT 30min Number of cycles : 100 cycles	B-131A	22
	7	Thermal Shock	Fluid : pure water (running water) High temp.side : 100+0/-5°C Low temp.side : 0+5/-0°C Duration time : HT 5min, LT 5min Number of cycles : 100 cycles	B-141A test code A	22
	8	Steady state Operating life	$T_a = 25 \pm 5^\circ\text{C}$ Rated load Test duration : 1000h	D-402	22
	9	Intermittent Operating Life	$T_j = T_{jmax} \sim 50$ 3min ON, 3min OFF Test duration : 10000cy	D-403	22
	10	High Temp. Reverse Bias	Temperature : $T_a = 100^\circ\text{C}$ Bias Voltage : $V_R = V_{RRM}$ duty=1/2 Test duration : 1000h	D-404	22

(0:1)

(0:1)

Failure Criteria	I_R USL x 5
	V_F USL x 1.1

USL:Upper specification Limit

This material and the information herein is the property of Fuji Electric Co., Ltd. They shall be neither reproduced, copied, lent, or disclosed in any way whatsoever for the use of any third party nor used for the manufacturing purposes without the express written consent of Fuji Electric Co., Ltd.

6. Cautions

· Although Fuji Electric is continually improving product quality and reliability, a small percentage of semiconductor products may become faulty. When using Fuji Electric semiconductor products in your are requested to take adequate safety measures to prevent the equipment from causing physical injury, fire, or other problem in case any of the products fail. It is recommended to make your design fail-safe, flame retardant, and free of malfunction.

· The products described in this Specification are intended for use in the following electronic and electrical equipment which has normal reliability requirements.

- Computers · OA equipment · Communications equipment (Terminal devices)
- Measurement equipment · Machine tools · AV equipment
- Electrical home appliances · Personal equipment · Industrial robots
- etc.

· The products described in this Specification are not designed or manufactured to be used in equipment or systems used under life-threatening situations. If you are considering using these products in the equipment listed below, first check the system construction and required reliability.

- Transportation equipment (automobiles, trains, ships, etc.)
- Backbone network equipment · Traffic-signal control equipment
- Gas alarms, leakage gas auto breakers · Submarine repeater equipment
- Burglar alarms, fire alarms, emergency equipment · Medical equipment
- Nuclear control equipment
- etc.

Do not use the products in this Specification for equipment requiring strict reliability such as (but not limited to):

- Aerospace equipment · Aeronautical equipment

7. Warnings

- The Diodes should be used in products within their absolute maximum rating (voltage, current, temperature, etc.). The Diodes may be destroyed if used beyond the rating.
- The equipment containing Diodes should have adequate fuses or protection to prevent the equipment from causing secondary destruction.
- Use the Diodes within their reliability and lifetime under certain environments or conditions. The Diodes may fail before the target lifetime of your products if used under certain reliability conditions.
- You must design the Diodes to be operated within the specified maximum ratings (voltage, current, temperature, etc.) to prevent possible failure or destruction of devices.
- Consider the possible temperature rise not only for the junction and case, but also for the leads.
- Do not directly touch the leads or package of the Diodes while power is supplied or during operation, to avoid electric shock and burns.

- The Diodes are made of incombustible material. However, if a Diode fails, it may emit smoke or flame. Also, operating the Diodes near any flammable place or material may cause the Diodes to emit smoke or flame in case the Diodes become even hotter during operation. Design the arrangement to prevent the spread of fire.
- The Diodes should not be used in an environment in the presence of acid, organic matter, or corrosive gas (hydrogen sulfide, sulfurous acid gas.)
- The Diodes should not be used in an irradiated field since they are not radiation-proof.

Installation

- Soldering involves temperatures which exceed the device storage temperature rating. To avoid device damage and to ensure reliability, observe the following guidelines from the quality assurance standard.
- Solder temperature and duration (through-hole package)

Solder temperature	Duration
260 ± 5	10 ± 1 second
350 ± 10	3.0 ± 0.5 second

- The immersion depth of the lead should basically be up to the lead stopper and the distance should be a maximum of 1.5mm from the device.
- When flow-soldering, take care to avoid immersing the package in the solder bath.
- Refer to the following torque reference when mounting the device on a heat sink. Excess torque applied to the mounting screw causes damage to the device and weak torque will increase the thermal resistance, both of which conditions may destroy the device.

Table 1: Recommended tightening torque

Package style	Screw	Recommended tightening torque
TO-220 TO-220F	M3	30-50Ncm
TO-3P TO-3PF TO-247	M3	40-60Ncm
TO-3PL	M3	60-80Ncm

- The heat sink should have a flatness within ± 50 μm and roughness within 10 μm. Also, keep the tightening torque within the limits of this specification.
- Improper handling may cause isolation breakdown leading to a critical accident.
- We recommend the use of thermal compound to optimize the efficiency of heat radiation. It is important to evenly apply the compound and to eliminate any air voids.

Storage

- The Diodes must be stored at a standard temperature of 5 to 35 °C and relative humidity of 45 to 75%. If the storage area is very dry, a humidifier may be required. In such a case, use only deionized water or boiled water, since the chlorine in tap water may corrode the leads.
- The Diodes should not be subjected to rapid changes in temperature to avoid condensation on the surface of the Diodes. Therefore, store the Diodes in a place where the temperature is steady.
- The Diodes should not be stored on top of each other, since this may cause excessive external force on the case.
- The Diodes should not be stored with the lead terminals remaining unprocessed. Rust may cause presoldered connections to go fail during later processing.
- The Diodes should be stored in antistatic containers or shipping bags.

This material and the information herein is the property of Fuji Electric Co., Ltd. They shall be neither reproduced, copied, lent, or disclosed in any way whatsoever for the use of any third party nor used for the manufacturing purposes without the express written consent of Fuji Electric Co., Ltd.

8. Appendix

- These products do not contain PBDs or PBBs.
- These products, assemblies, or components do not contain any of the above-mentioned substances.

Prohibited substances:

CFCs, halon, carbon tetrachloride, 1,1,1-trichloroethane (methyl chloroform)

These products, assemblies, or components are not manufactured using any of the above-mentioned substances.

Prohibited substances:

CFCs, halon, carbon tetrachloride, 1,1,1-trichloroethane (methyl chloroform)

- If you have any questions about any part of this Specification, please contact Fuji Electric or its sales agent before using the product
- Neither Fuji nor its agents shall be held liable for any injury caused by using the products not in accordance with the instructions.
- The application examples described in this specification are merely typical uses of Fuji Electric products.
This specification does not confer any industrial property rights or other rights, nor constitute a license for such rights.

EEPW 电子产品世界
.com.cn

FUJI SILICON DIODE

TYPE : YG963S1R

OUT VIEW 外形寸法図

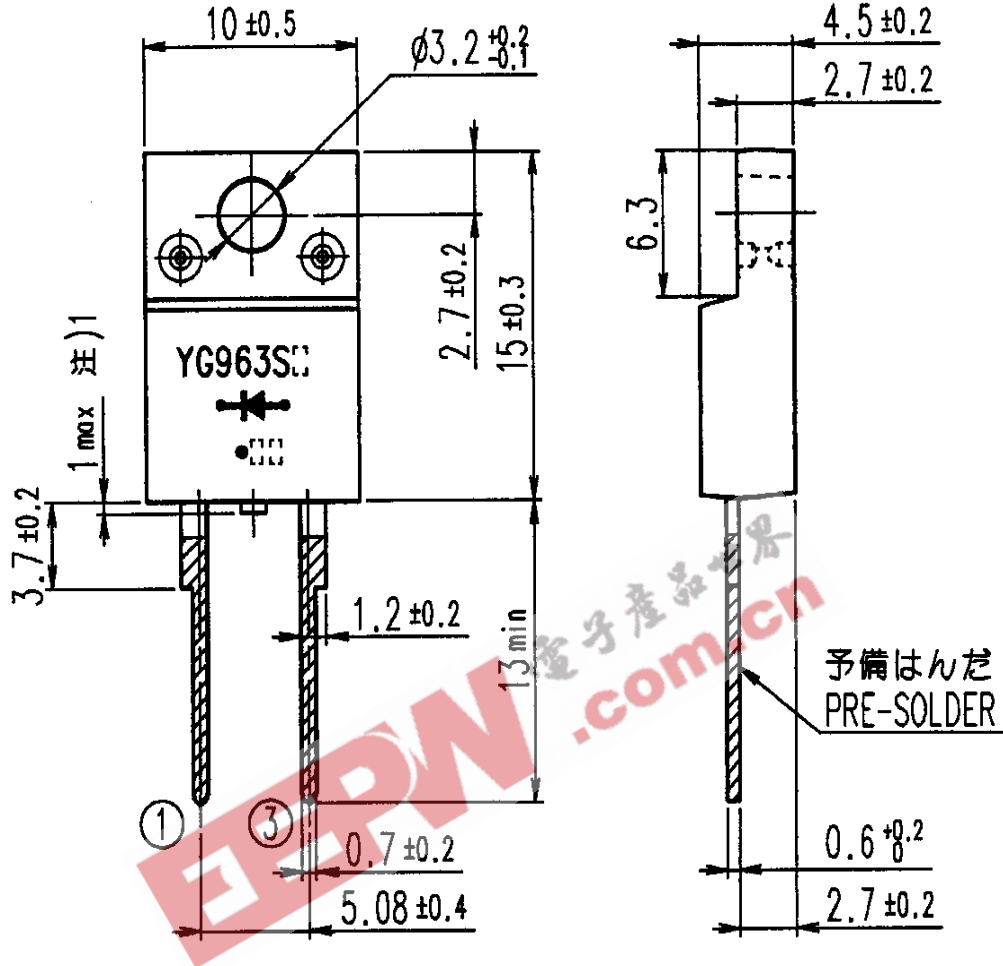

MARKING 表示内容

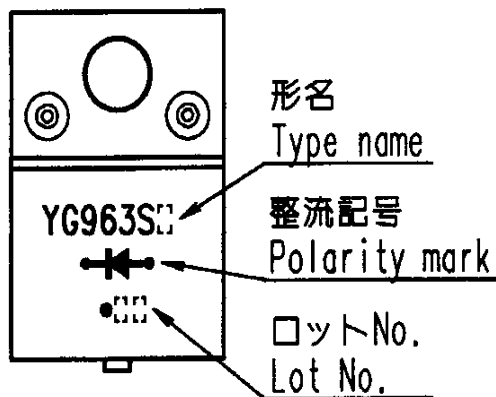

CONNECTION 結線図



注) 1. 端子間 (3端子品におけるセンター端子部 = 破線部) の樹脂残りは、1.0mm 以下とする。

UNIT : mm
寸法単位 : mm

This material and the information herein is the property of Fuji Electric Co., Ltd. They shall be neither reproduced, copied, lent, or disclosed in any way whatsoever for the use of any third party nor used for the manufacturing purposes without the express written consent of Fuji Electric Co., Ltd.

This material and the information herein is the property of Fuji Electric Co., Ltd. They shall be neither reproduced, copied, lent, or disclosed in any way whatsoever for the use of any third party nor used for the manufacturing purposes without the express written consent of Fuji Electric Co., Ltd.

Forward Characteristic (typ.)

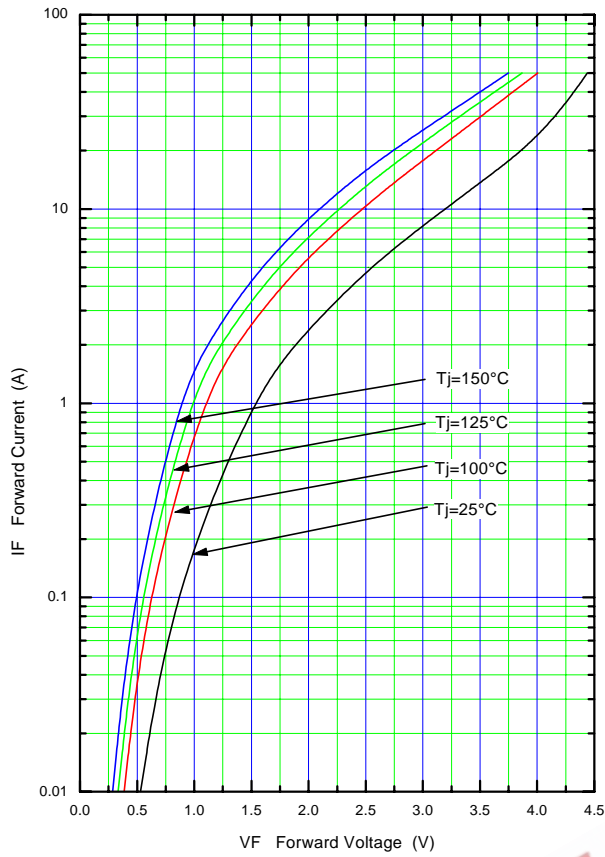

Reverse Characteristic (typ.)

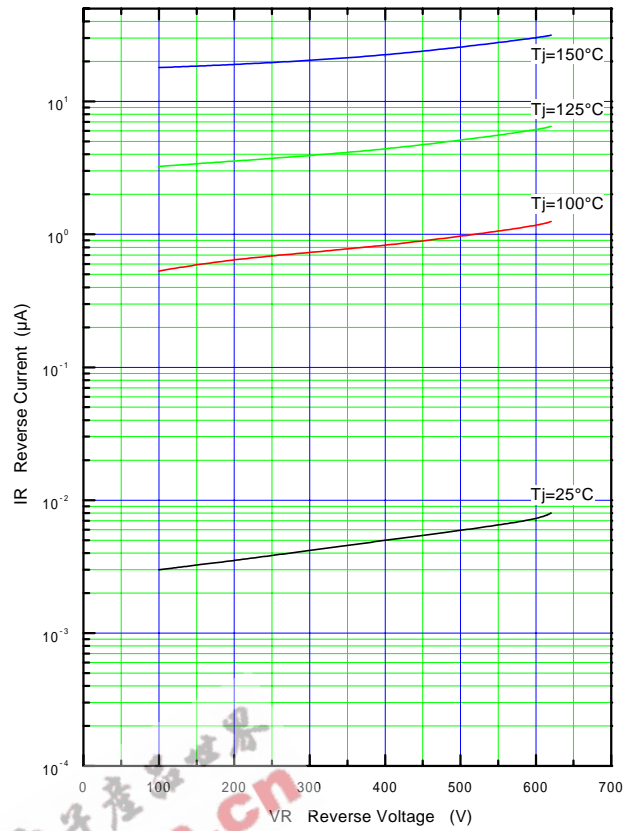

Forward Power Dissipation

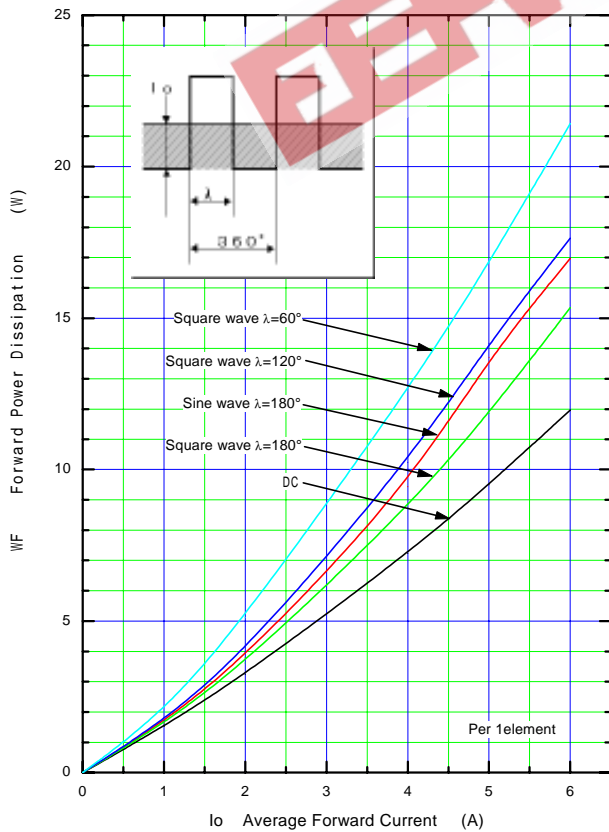

Reverse Power Dissipation

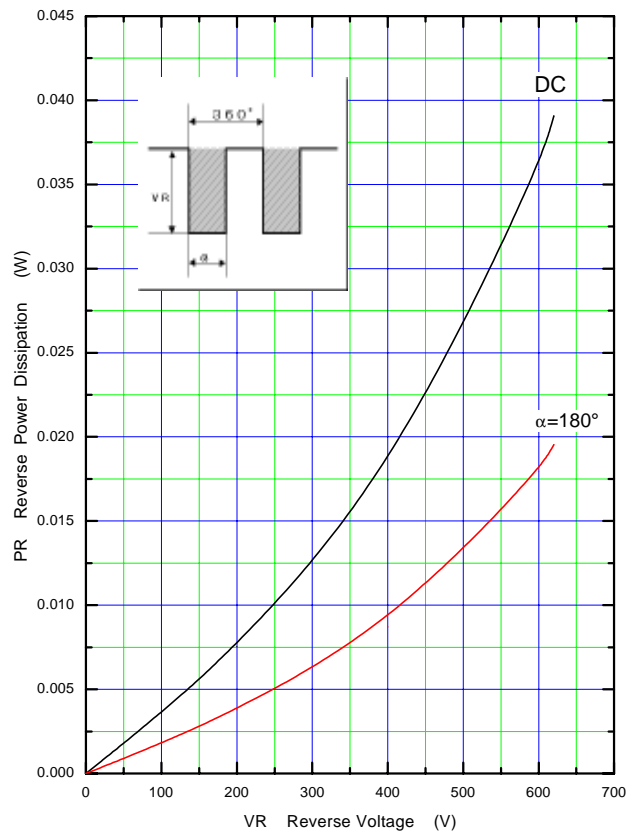

This material and the information herein is the property of Fuji Electric Co., Ltd. They shall be neither reproduced, copied, lent, or disclosed in any way whatsoever for the use of any third party nor used for the manufacturing purposes without the express written consent of Fuji Electric Co., Ltd.

Current Derating (I_o-T_c)

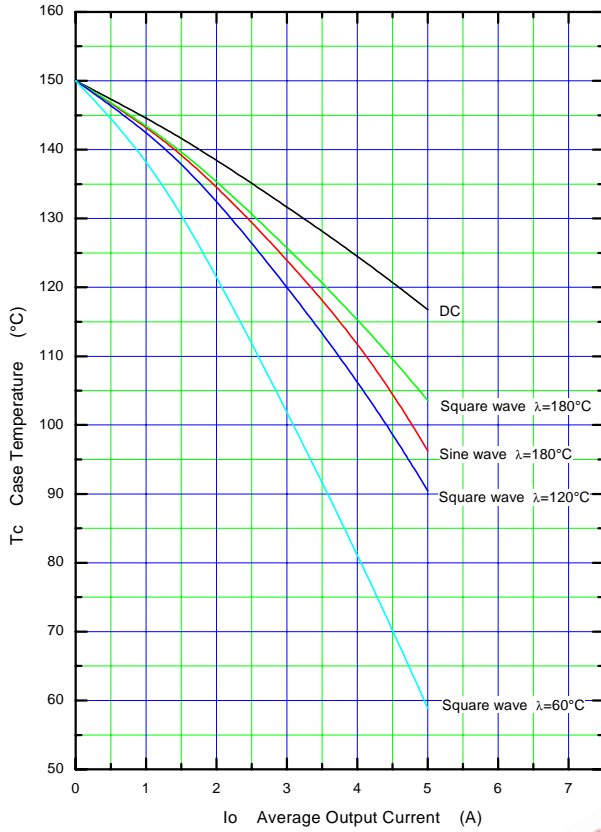

λ: Conduction angle of forward current for each rectifier element
I_o: Output current of center-tap full wave connection

Junction Capacitance Characteristic (typ.)

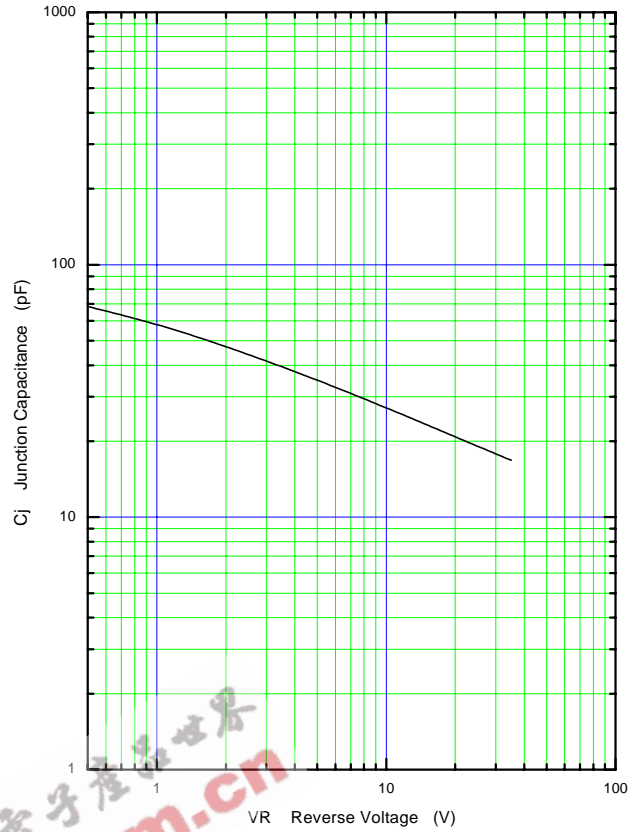

Surge Capability

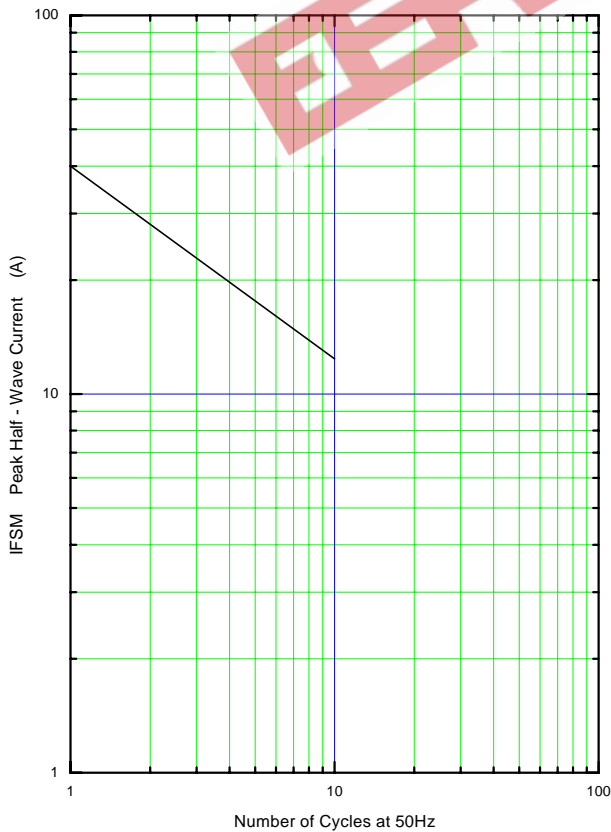

This material and the information herein is the property of Fuji Electric Co., Ltd. They shall be neither reproduced, copied, lent, or disclosed in any way whatsoever for the use of any third party nor used for the manufacturing purposes without the express written consent of Fuji Electric Co., Ltd.

