

### features

- High Q factor
- Low T.C.C.
- Available in high capacitance values (up to 100  $\mu$ F)

### dimensions and construction

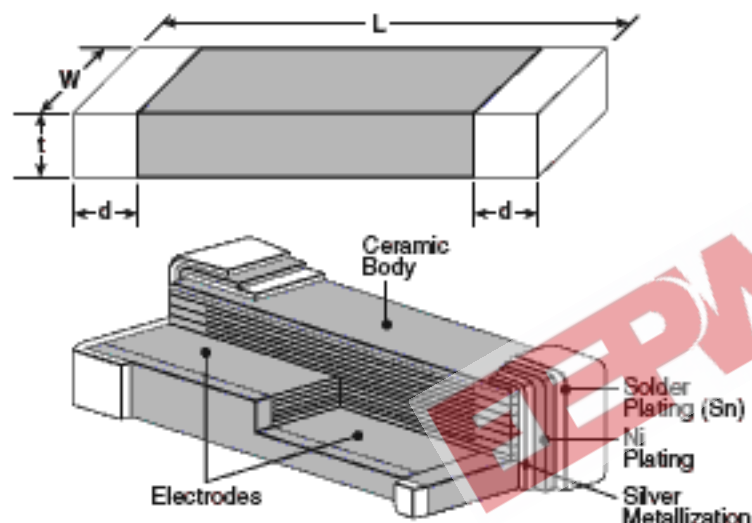

| Case Size | Dimensions inches (mm)  |                          |                |                          |
|-----------|-------------------------|--------------------------|----------------|--------------------------|
|           | L                       | W                        | t (Max.)       | d                        |
| 0402      | .039±.004<br>(1.0±0.1)  | .02±.004<br>(0.5±0.1)    | .021<br>(0.55) | .01±.006<br>(0.25±0.15)  |
| 0603      | .063±.006<br>(1.6±0.15) | .032±.006<br>(0.81±0.15) | .035<br>(0.9)  | .014±.006<br>(0.35±0.15) |
| 0805      | .079±.008<br>(2.01±0.2) | .049±.008<br>(1.25±0.2)  | .051<br>(1.3)  | .02±.01<br>(0.50±0.25)   |
| 1206      | .126±.008<br>(3.2±0.2)  | .069±.008<br>(1.6±0.2)   | .059<br>(1.5)  | .02±.01<br>(0.5±0.25)    |
| 1210      | .126±.008<br>(3.2±0.2)  | .098±.008<br>(2.5±0.2)   | .067<br>(1.7)  | .02±.01<br>(0.5±0.25)    |
| 1812      | .177±.012<br>(4.5±0.3)  | .126±.008<br>(3.2±0.2)   | .067<br>(1.7)  | .024±.014<br>(0.61±0.36) |
| 1825      | .177±.012<br>(4.5±0.3)  | .252±.016<br>(6.4±0.4)   | .067<br>(1.7)  | .024±.014<br>(0.61±0.36) |
| 2220      | .224±.016<br>(5.7±0.4)  | .197±.016<br>(5.0±0.4)   | .087<br>(2.2)  | .025±.015<br>(0.64±0.39) |

### ordering information

| Old Part # | 0805                            | NPO  | H  | T                    | T  | 101   | K  |
|------------|---------------------------------|--|--|----------------------|--|---|--|
| New Part # | NPO                             | 0805   | H  | T                    | TD   | 101   | K  |
|            | Dielectric                      | Size   | Voltage  | Termination Material | Packaging  | Capacitance   | Tolerance  |
|            | NPO<br>X5R<br>X7R<br>Y5V<br>Z5U | 0402<br>0603<br>0805<br>1206<br>1210<br>1812<br>1825<br>2220 | A = 10V<br>C = 16V<br>E = 25V<br>H = 50V<br>I = 100V<br>J = 200V<br>K = 6.3V | T: Sn                | TP: 7" 2mm pitch (0402 only)<br>TD: 7" paper tape<br>TE: 7" embossed plastic<br>TDB: 13" paper tape<br>TEB: 13" embossed plastic | NPO, X5R, X7R, Y5V:<br>2 significant digits + no. of zeros.<br>"R" indicates decimal point<br>Z5U:<br>2 significant digits + no. of zeros | B: ±0.1pF<br>C: ±0.25pF<br>D: ±0.5pF<br>F: ±1%<br>G: ±2%<br>J: ±5%<br>K: ±10%<br>M: ±20%<br>Z: +80, -20% |

For further information on packaging, please refer to Appendix B.

### applications and ratings

| Dielectric | Capacitance Range | Capacitance Tolerance*  | Voltage Ratings                          | Dissipation Factor   | T.C.C.            | Test Voltage   | Operating Temperature | Insulation Resistance                                       |
|------------|-------------------|---|--|--|-------------------|----------------|-----------------------|---|
| NPO        | 0.5pF - 0.033μF   | B: ±0.1pF (1.0pF - 8.2pF)<br>C: ±0.25pF (1.0pF - 8.2pF)<br>D: ±0.5pF (5.6pF - 8.2pF)<br>F: ±1%, G: ±2%<br>J: ±5%, K: ±10% | 16V<br>25V<br>50V<br>100V<br>200V        | For Values >30pF: 0.1% max., ≤30pF: Q = 400 + 20 x C<br>DF = 1/Q<br>C is in pF | 0 ± 30 ppm/°C     | 1.0 ± 0.2 Vrms | -55°C to +125°C       | +25°C 100,000MΩ min. or 1000 MΩ - μF min. whichever is less |
| X5R        | 0.068μF - 100μF   | K: ±10%   | 6.3V<br>10V                              | 6.3 = 7.5%<br>10 = 5.0%  | ±15% (0 VDC)      | 1.0 ± 0.2 Vrms | -55°C to +85°C        | +25°C 100,000MΩ min. or 500 MΩ - μF min. whichever is less  |
| X7R        | 100pF - 1.0μF     | K: ±10%   | 10V<br>16V<br>25V<br>50V<br>100V<br>200V | For 50 & 100 volts<br>2.5% max.<br>25 = 3.0%<br>16 = 3.5%                      | ±15% (0 VDC)      | 1.0 ± 0.2 Vrms | -55°C to +125°C       | +25°C 100,000MΩ min. or 1000 MΩ - μF min. whichever is less |
| Y5V        | 2200pF - 4.7μF    | Z: +80, -20%  | 10V<br>16V<br>25V<br>50V                 | 16V & 25V = 7.0%<br>50V = 5.0%   | +22% to -82% max. | 1.0 ± 0.2 Vrms | -55°C to +125°C       | +25°C 10,000MΩ min. or 1000 MΩ - μF min. whichever is less  |
| Z5U        | 0.01 μF - 1.0μF   | M: ±20%<br>Z: +80, -20%   | 25V<br>50V                               | 4.0% max.  | +22% to -56% max. | 0.5 ± 0.2 Vrms | -55°C to +125°C       | +25°C 10,000MΩ min. or 1000 MΩ - μF min. whichever is less  |

\* Special tolerances available, please consult factory.

### environmental applications

Insulation Resistance vs Temp.

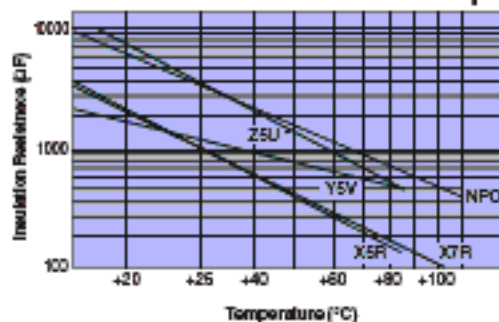

NPO - Temperature Coefficient

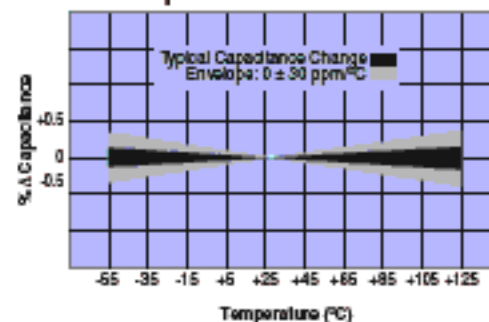

X5R - Temperature Coefficient

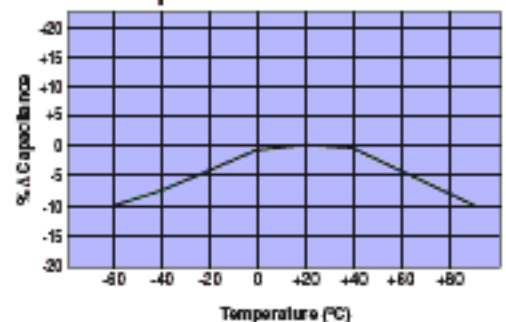

X7R - Temperature Coefficient

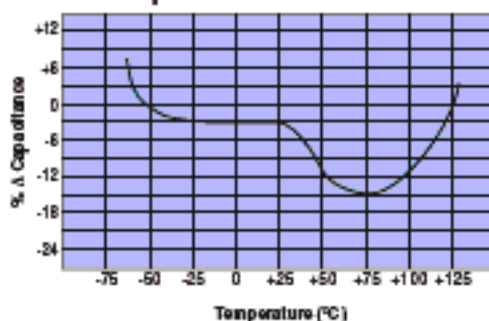

Y5V - Temperature Coefficient

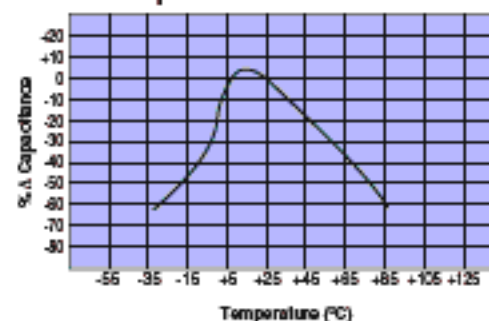

Z5U - Temperature Coefficient

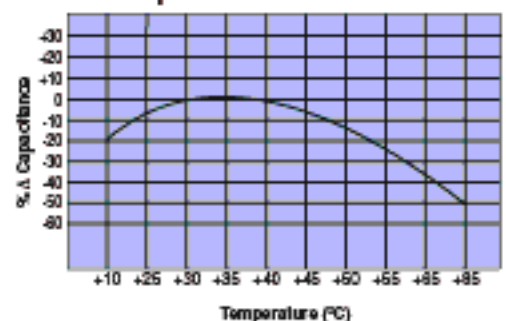

## NPO capacitance voltage availability

| Size                     |              |      |  | 0402* |    |    | 0603* |     | 0805 |     |     | 1206 |    |     |     | 1210 |     |     |
|--------------------------|--------------|------|--|-------|----|----|-------|-----|------|-----|-----|------|----|-----|-----|------|-----|-----|
| Capacitance values<br>pF | Code         | WVDC |  | 16    | 25 | 50 | 50    | 100 | 50   | 100 | 200 | 25   | 50 | 100 | 200 | 50   | 200 | 500 |
| 0.47                     | R47          |      |  |       |    |    |       |     |      |     |     |      |    |     |     |      |     |     |
| 0.56                     | R56          |      |  |       |    |    |       |     |      |     |     |      |    |     |     |      |     |     |
| 0.68                     | R68          |      |  |       |    |    |       |     |      |     |     |      |    |     |     |      |     |     |
| 0.82                     | R82          |      |  |       |    |    |       |     |      |     |     |      |    |     |     |      |     |     |
| 1                        | 1R0          |      |  |       |    |    |       |     |      |     |     |      |    |     |     |      |     |     |
| 1.2                      | 1R2PF        |      |  |       |    |    |       |     |      |     |     |      |    |     |     |      |     |     |
| 1.5                      | 1R5PF        |      |  |       |    |    |       |     |      |     |     |      |    |     |     |      |     |     |
| 1.8                      | 1R8PF        |      |  |       |    |    |       |     |      |     |     |      |    |     |     |      |     |     |
| 2.2                      | 2R2PF        |      |  |       |    |    |       |     |      |     |     |      |    |     |     |      |     |     |
| 2.7                      | 2R7PF        |      |  |       |    |    |       |     |      |     |     |      |    |     |     |      |     |     |
| 3.3                      | 3R3PF        |      |  |       |    |    |       |     |      |     |     |      |    |     |     |      |     |     |
| 3.9                      | 3R9PF        |      |  |       |    |    |       |     |      |     |     |      |    |     |     |      |     |     |
| 4.7                      | 4R7PF        |      |  |       |    |    |       |     |      |     |     |      |    |     |     |      |     |     |
| 5.6                      | 5R6PF        |      |  |       |    |    |       |     |      |     |     |      |    |     |     |      |     |     |
| 6.8                      | 6R8PF        |      |  |       |    |    |       |     |      |     |     |      |    |     |     |      |     |     |
| 8.2                      | 8R2PF        |      |  |       |    |    |       |     |      |     |     |      |    |     |     |      |     |     |
| 10                       | 100PF        |      |  |       |    |    |       |     |      |     |     |      |    |     |     |      |     |     |
| 12                       | 120PF        |      |  |       |    |    |       |     |      |     |     |      |    |     |     |      |     |     |
| 15                       | 150PF        |      |  |       |    |    |       |     |      |     |     |      |    |     |     |      |     |     |
| 18                       | 180PF        |      |  |       |    |    |       |     |      |     |     |      |    |     |     |      |     |     |
| 22                       | 220PF        |      |  |       |    |    |       |     |      |     |     |      |    |     |     |      |     |     |
| 27                       | 270PF        |      |  |       |    |    |       |     |      |     |     |      |    |     |     |      |     |     |
| 33                       | 330PF        |      |  |       |    |    |       |     |      |     |     |      |    |     |     |      |     |     |
| 39                       | 390PF        |      |  |       |    |    |       |     |      |     |     |      |    |     |     |      |     |     |
| 47                       | 470PF        |      |  |       |    |    |       |     |      |     |     |      |    |     |     |      |     |     |
| 56                       | 560PF        |      |  |       |    |    |       |     |      |     |     |      |    |     |     |      |     |     |
| 68                       | 680PF        |      |  |       |    |    |       |     |      |     |     |      |    |     |     |      |     |     |
| 82                       | 820PF        |      |  |       |    |    |       |     |      |     |     |      |    |     |     |      |     |     |
| 100                      | .0001 101PF  |      |  |       |    |    |       |     |      |     |     |      |    |     |     |      |     |     |
| 120                      | .00012 121PF |      |  |       |    |    |       |     |      |     |     |      |    |     |     |      |     |     |
| 150                      | .00015 151PF |      |  |       |    |    |       |     |      |     |     |      |    |     |     |      |     |     |
| 180                      | .00018 181PF |      |  |       |    |    |       |     |      |     |     |      |    |     |     |      |     |     |
| 220                      | .00022 221PF |      |  |       |    |    |       |     |      |     |     |      |    |     |     |      |     |     |
| 270                      | .00027 271PF |      |  |       |    |    |       |     |      |     |     |      |    |     |     |      |     |     |
| 330                      | .00033 331PF |      |  |       |    |    |       |     |      |     |     |      |    |     |     |      |     |     |
| 390                      | .00039 391PF |      |  |       |    |    |       |     |      |     |     |      |    |     |     |      |     |     |
| 470                      | .00047 471PF |      |  |       |    |    |       |     |      |     |     |      |    |     |     |      |     |     |
| 560                      | .00056 561PF |      |  |       |    |    |       |     |      |     |     |      |    |     |     |      |     |     |
| 680                      | .00068 681PF |      |  |       |    |    |       |     |      |     |     |      |    |     |     |      |     |     |
| 820                      | .00082 821PF |      |  |       |    |    |       |     |      |     |     |      |    |     |     |      |     |     |
| 1000                     | .0010 102PF  |      |  |       |    |    |       |     |      |     |     |      |    |     |     |      |     |     |
| 1200                     | .0012 122PF  |      |  |       |    |    |       |     |      |     |     |      |    |     |     |      |     |     |
| 1500                     | .0015 152PF  |      |  |       |    |    |       |     |      |     |     |      |    |     |     |      |     |     |
| 1800                     | .0018 182PF  |      |  |       |    |    |       |     |      |     |     |      |    |     |     |      |     |     |
| 2200                     | .0022 222PF  |      |  |       |    |    |       |     |      |     |     |      |    |     |     |      |     |     |
| 2700                     | .0027 272PF  |      |  |       |    |    |       |     |      |     |     |      |    |     |     |      |     |     |
| 3300                     | .0033 332PF  |      |  |       |    |    |       |     |      |     |     |      |    |     |     |      |     |     |
| 3900                     | .0039 392PF  |      |  |       |    |    |       |     |      |     |     |      |    |     |     |      |     |     |
| 4700                     | .0047 472PF  |      |  |       |    |    |       |     |      |     |     |      |    |     |     |      |     |     |
| 5600                     | .0056 562PF  |      |  |       |    |    |       |     |      |     |     |      |    |     |     |      |     |     |
| 6800                     | .0068 682PF  |      |  |       |    |    |       |     |      |     |     |      |    |     |     |      |     |     |
| 8200                     | .0082 822PF  |      |  |       |    |    |       |     |      |     |     |      |    |     |     |      |     |     |
| 10000                    | .010 103PF   |      |  |       |    |    |       |     |      |     |     |      |    |     |     |      |     |     |
| 12000                    | .012 123PF   |      |  |       |    |    |       |     |      |     |     |      |    |     |     |      |     |     |
| 15000                    | .015 153PF   |      |  |       |    |    |       |     |      |     |     |      |    |     |     |      |     |     |
| 18000                    | .018 183PF   |      |  |       |    |    |       |     |      |     |     |      |    |     |     |      |     |     |
| 22000                    | .022 223PF   |      |  |       |    |    |       |     |      |     |     |      |    |     |     |      |     |     |
| 27000                    | .027 273PF   |      |  |       |    |    |       |     |      |     |     |      |    |     |     |      |     |     |
| 33000                    | .033 333PF   |      |  |       |    |    |       |     |      |     |     |      |    |     |     |      |     |     |
| 39000                    | .039 393PF   |      |  |       |    |    |       |     |      |     |     |      |    |     |     |      |     |     |

\* IR and vapor phase solder only recommended

Capacitance tolerance available:

R47 ~ 8R2 = C:  $\pm 0.25$  pF, 5R6 ~ 8R2 = D  $\pm 0.5$  pF, 10 ~ 393 = J  $\pm 5\%$ , F  $\pm 1\%$ , G  $\pm 2\%$

## X5R capacitance voltage availability

| Size                           | 0402 |    |    | 0603 |    |    |    | 0805 |    |    |    | 1206 |    |    |    | 1210 |    |    |    | 1812 |    |    |    | 2220 |    |    |    |     |  |
|--------------------------------|------|----|----|------|----|----|----|------|----|----|----|------|----|----|----|------|----|----|----|------|----|----|----|------|----|----|----|-----|--|
| Capacitance values<br>pF<br>μF | 6.3  | 10 | 16 | 6.3  | 10 | 16 | 25 | 6.3  | 10 | 16 | 25 | 6.3  | 10 | 16 | 25 | 6.3  | 10 | 16 | 25 | 6.3  | 10 | 16 | 25 | 6.3  | 10 | 16 | 25 | 6.3 |  |
| 100                            |      |    |    |      |    |    |    |      |    |    |    |      |    |    |    |      |    |    |    |      |    |    |    |      |    |    |    |     |  |
| 150                            |      |    |    |      |    |    |    |      |    |    |    |      |    |    |    |      |    |    |    |      |    |    |    |      |    |    |    |     |  |
| 220                            |      |    |    |      |    |    |    |      |    |    |    |      |    |    |    |      |    |    |    |      |    |    |    |      |    |    |    |     |  |
| 330                            |      |    |    |      |    |    |    |      |    |    |    |      |    |    |    |      |    |    |    |      |    |    |    |      |    |    |    |     |  |
| 470                            |      |    |    |      |    |    |    |      |    |    |    |      |    |    |    |      |    |    |    |      |    |    |    |      |    |    |    |     |  |
| 680                            |      |    |    |      |    |    |    |      |    |    |    |      |    |    |    |      |    |    |    |      |    |    |    |      |    |    |    |     |  |
| 1000                           |      |    |    |      |    |    |    |      |    |    |    |      |    |    |    |      |    |    |    |      |    |    |    |      |    |    |    |     |  |
| 1200                           |      |    |    |      |    |    |    |      |    |    |    |      |    |    |    |      |    |    |    |      |    |    |    |      |    |    |    |     |  |
| 1500                           |      |    |    |      |    |    |    |      |    |    |    |      |    |    |    |      |    |    |    |      |    |    |    |      |    |    |    |     |  |
| 1800                           |      |    |    |      |    |    |    |      |    |    |    |      |    |    |    |      |    |    |    |      |    |    |    |      |    |    |    |     |  |
| 2200                           |      |    |    |      |    |    |    |      |    |    |    |      |    |    |    |      |    |    |    |      |    |    |    |      |    |    |    |     |  |
| 2700                           |      |    |    |      |    |    |    |      |    |    |    |      |    |    |    |      |    |    |    |      |    |    |    |      |    |    |    |     |  |
| 3300                           |      |    |    |      |    |    |    |      |    |    |    |      |    |    |    |      |    |    |    |      |    |    |    |      |    |    |    |     |  |
| 3900                           |      |    |    |      |    |    |    |      |    |    |    |      |    |    |    |      |    |    |    |      |    |    |    |      |    |    |    |     |  |
| 4700                           |      |    |    |      |    |    |    |      |    |    |    |      |    |    |    |      |    |    |    |      |    |    |    |      |    |    |    |     |  |
| 5600                           |      |    |    |      |    |    |    |      |    |    |    |      |    |    |    |      |    |    |    |      |    |    |    |      |    |    |    |     |  |
| 6800                           |      |    |    |      |    |    |    |      |    |    |    |      |    |    |    |      |    |    |    |      |    |    |    |      |    |    |    |     |  |
| 8200                           |      |    |    |      |    |    |    |      |    |    |    |      |    |    |    |      |    |    |    |      |    |    |    |      |    |    |    |     |  |
| 0.010                          |      |    |    |      |    |    |    |      |    |    |    |      |    |    |    |      |    |    |    |      |    |    |    |      |    |    |    |     |  |
| 0.012                          |      |    |    |      |    |    |    |      |    |    |    |      |    |    |    |      |    |    |    |      |    |    |    |      |    |    |    |     |  |
| 0.015                          |      |    |    |      |    |    |    |      |    |    |    |      |    |    |    |      |    |    |    |      |    |    |    |      |    |    |    |     |  |
| 0.018                          |      |    |    |      |    |    |    |      |    |    |    |      |    |    |    |      |    |    |    |      |    |    |    |      |    |    |    |     |  |
| 0.022                          |      |    |    |      |    |    |    |      |    |    |    |      |    |    |    |      |    |    |    |      |    |    |    |      |    |    |    |     |  |
| 0.027                          |      |    |    |      |    |    |    |      |    |    |    |      |    |    |    |      |    |    |    |      |    |    |    |      |    |    |    |     |  |
| 0.033                          |      |    |    |      |    |    |    |      |    |    |    |      |    |    |    |      |    |    |    |      |    |    |    |      |    |    |    |     |  |
| 0.039                          |      |    |    |      |    |    |    |      |    |    |    |      |    |    |    |      |    |    |    |      |    |    |    |      |    |    |    |     |  |
| 0.047                          |      |    |    |      |    |    |    |      |    |    |    |      |    |    |    |      |    |    |    |      |    |    |    |      |    |    |    |     |  |
| 0.056                          |      |    |    |      |    |    |    |      |    |    |    |      |    |    |    |      |    |    |    |      |    |    |    |      |    |    |    |     |  |
| 0.068                          |      |    |    |      |    |    |    |      |    |    |    |      |    |    |    |      |    |    |    |      |    |    |    |      |    |    |    |     |  |
| 0.082                          |      |    |    |      |    |    |    |      |    |    |    |      |    |    |    |      |    |    |    |      |    |    |    |      |    |    |    |     |  |
| 0.10                           |      |    |    |      |    |    |    |      |    |    |    |      |    |    |    |      |    |    |    |      |    |    |    |      |    |    |    |     |  |
| 0.12                           |      |    |    |      |    |    |    |      |    |    |    |      |    |    |    |      |    |    |    |      |    |    |    |      |    |    |    |     |  |
| 0.15                           |      |    |    |      |    |    |    |      |    |    |    |      |    |    |    |      |    |    |    |      |    |    |    |      |    |    |    |     |  |
| 0.18                           |      |    |    |      |    |    |    |      |    |    |    |      |    |    |    |      |    |    |    |      |    |    |    |      |    |    |    |     |  |
| 0.22                           |      |    |    |      |    |    |    |      |    |    |    |      |    |    |    |      |    |    |    |      |    |    |    |      |    |    |    |     |  |
| 0.27                           |      |    |    |      |    |    |    |      |    |    |    |      |    |    |    |      |    |    |    |      |    |    |    |      |    |    |    |     |  |
| 0.33                           |      |    |    |      |    |    |    |      |    |    |    |      |    |    |    |      |    |    |    |      |    |    |    |      |    |    |    |     |  |
| 0.47                           |      |    |    |      |    |    |    |      |    |    |    |      |    |    |    |      |    |    |    |      |    |    |    |      |    |    |    |     |  |
| 0.56                           |      |    |    |      |    |    |    |      |    |    |    |      |    |    |    |      |    |    |    |      |    |    |    |      |    |    |    |     |  |
| 0.68                           |      |    |    |      |    |    |    |      |    |    |    |      |    |    |    |      |    |    |    |      |    |    |    |      |    |    |    |     |  |
| 0.82                           |      |    |    |      |    |    |    |      |    |    |    |      |    |    |    |      |    |    |    |      |    |    |    |      |    |    |    |     |  |
| 1.0                            |      |    |    |      |    |    |    |      |    |    |    |      |    |    |    |      |    |    |    |      |    |    |    |      |    |    |    |     |  |
| 1.2                            |      |    |    |      |    |    |    |      |    |    |    |      |    |    |    |      |    |    |    |      |    |    |    |      |    |    |    |     |  |
| 1.5                            |      |    |    |      |    |    |    |      |    |    |    |      |    |    |    |      |    |    |    |      |    |    |    |      |    |    |    |     |  |
| 1.8                            |      |    |    |      |    |    |    |      |    |    |    |      |    |    |    |      |    |    |    |      |    |    |    |      |    |    |    |     |  |
| 2.2                            |      |    |    |      |    |    |    |      |    |    |    |      |    |    |    |      |    |    |    |      |    |    |    |      |    |    |    |     |  |
| 3.3                            |      |    |    |      |    |    |    |      |    |    |    |      |    |    |    |      |    |    |    |      |    |    |    |      |    |    |    |     |  |
| 4.7                            |      |    |    |      |    |    |    |      |    |    |    |      |    |    |    |      |    |    |    |      |    |    |    |      |    |    |    |     |  |
| 6.8                            |      |    |    |      |    |    |    |      |    |    |    |      |    |    |    |      |    |    |    |      |    |    |    |      |    |    |    |     |  |
| 10                             |      |    |    |      |    |    |    |      |    |    |    |      |    |    |    |      |    |    |    |      |    |    |    |      |    |    |    |     |  |
| 22                             |      |    |    |      |    |    |    |      |    |    |    |      |    |    |    |      |    |    |    |      |    |    |    |      |    |    |    |     |  |
| 47                             |      |    |    |      |    |    |    |      |    |    |    |      |    |    |    |      |    |    |    |      |    |    |    |      |    |    |    |     |  |
| 100                            |      |    |    |      |    |    |    |      |    |    |    |      |    |    |    |      |    |    |    |      |    |    |    |      |    |    |    |     |  |

Capacitance tolerance available: ±10%

## X7R capacitance voltage availability

| Size    | 0402*  |       |    | 0603* |    |    |    | 0805 |    |    |    |    | 1206 |     |    |    |    | 1210 |     |     |    |     |     |  |
|---------|--------|-------|----|-------|----|----|----|------|----|----|----|----|------|-----|----|----|----|------|-----|-----|----|-----|-----|--|
|         | 16     | 25    | 50 | 10    | 16 | 25 | 50 | 100  | 10 | 16 | 25 | 50 | 100  | 200 | 10 | 16 | 25 | 50   | 100 | 200 | 50 | 100 | 200 |  |
| 100     | .0001  | 101PF |    |       |    |    |    |      |    |    |    |    |      |     |    |    |    |      |     |     |    |     |     |  |
| 120     | .00012 | 121PF |    |       |    |    |    |      |    |    |    |    |      |     |    |    |    |      |     |     |    |     |     |  |
| 150     | .00015 | 151PF |    |       |    |    |    |      |    |    |    |    |      |     |    |    |    |      |     |     |    |     |     |  |
| 180     | .00018 | 181PF |    |       |    |    |    |      |    |    |    |    |      |     |    |    |    |      |     |     |    |     |     |  |
| 220     | .00022 | 221PF |    |       |    |    |    |      |    |    |    |    |      |     |    |    |    |      |     |     |    |     |     |  |
| 270     | .00027 | 271PF |    |       |    |    |    |      |    |    |    |    |      |     |    |    |    |      |     |     |    |     |     |  |
| 330     | .00033 | 331PF |    |       |    |    |    |      |    |    |    |    |      |     |    |    |    |      |     |     |    |     |     |  |
| 390     | .00039 | 391PF |    |       |    |    |    |      |    |    |    |    |      |     |    |    |    |      |     |     |    |     |     |  |
| 470     | .00047 | 471PF |    |       |    |    |    |      |    |    |    |    |      |     |    |    |    |      |     |     |    |     |     |  |
| 560     | .00056 | 561PF |    |       |    |    |    |      |    |    |    |    |      |     |    |    |    |      |     |     |    |     |     |  |
| 680     | .00068 | 681PF |    |       |    |    |    |      |    |    |    |    |      |     |    |    |    |      |     |     |    |     |     |  |
| 820     | .00082 | 821PF |    |       |    |    |    |      |    |    |    |    |      |     |    |    |    |      |     |     |    |     |     |  |
| 1000    | .0010  | 102PF |    |       |    |    |    |      |    |    |    |    |      |     |    |    |    |      |     |     |    |     |     |  |
| 1200    | .0012  | 122PF |    |       |    |    |    |      |    |    |    |    |      |     |    |    |    |      |     |     |    |     |     |  |
| 1500    | .0015  | 152PF |    |       |    |    |    |      |    |    |    |    |      |     |    |    |    |      |     |     |    |     |     |  |
| 1800    | .0018  | 182PF |    |       |    |    |    |      |    |    |    |    |      |     |    |    |    |      |     |     |    |     |     |  |
| 2200    | .0022  | 222PF |    |       |    |    |    |      |    |    |    |    |      |     |    |    |    |      |     |     |    |     |     |  |
| 2700    | .0027  | 272PF |    |       |    |    |    |      |    |    |    |    |      |     |    |    |    |      |     |     |    |     |     |  |
| 3300    | .0033  | 332PF |    |       |    |    |    |      |    |    |    |    |      |     |    |    |    |      |     |     |    |     |     |  |
| 3900    | .0039  | 392PF |    |       |    |    |    |      |    |    |    |    |      |     |    |    |    |      |     |     |    |     |     |  |
| 4700    | .0047  | 472PF |    |       |    |    |    |      |    |    |    |    |      |     |    |    |    |      |     |     |    |     |     |  |
| 5600    | .0056  | 562PF |    |       |    |    |    |      |    |    |    |    |      |     |    |    |    |      |     |     |    |     |     |  |
| 6800    | .0068  | 682PF |    |       |    |    |    |      |    |    |    |    |      |     |    |    |    |      |     |     |    |     |     |  |
| 8200    | .0082  | 822PF |    |       |    |    |    |      |    |    |    |    |      |     |    |    |    |      |     |     |    |     |     |  |
| 10000   | .010   | 103PF |    |       |    |    |    |      |    |    |    |    |      |     |    |    |    |      |     |     |    |     |     |  |
| 12000   | .012   | 123PF |    |       |    |    |    |      |    |    |    |    |      |     |    |    |    |      |     |     |    |     |     |  |
| 15000   | .015   | 153PF |    |       |    |    |    |      |    |    |    |    |      |     |    |    |    |      |     |     |    |     |     |  |
| 18000   | .018   | 183PF |    |       |    |    |    |      |    |    |    |    |      |     |    |    |    |      |     |     |    |     |     |  |
| 22000   | .022   | 223PF |    |       |    |    |    |      |    |    |    |    |      |     |    |    |    |      |     |     |    |     |     |  |
| 27000   | .027   | 273PF |    |       |    |    |    |      |    |    |    |    |      |     |    |    |    |      |     |     |    |     |     |  |
| 33000   | .033   | 333PF |    |       |    |    |    |      |    |    |    |    |      |     |    |    |    |      |     |     |    |     |     |  |
| 39000   | .039   | 393PF |    |       |    |    |    |      |    |    |    |    |      |     |    |    |    |      |     |     |    |     |     |  |
| 47000   | .047   | 473PF |    |       |    |    |    |      |    |    |    |    |      |     |    |    |    |      |     |     |    |     |     |  |
| 56000   | .056   | 563PF |    |       |    |    |    |      |    |    |    |    |      |     |    |    |    |      |     |     |    |     |     |  |
| 68000   | .068   | 683PF |    |       |    |    |    |      |    |    |    |    |      |     |    |    |    |      |     |     |    |     |     |  |
| 82000   | .082   | 823PF |    |       |    |    |    |      |    |    |    |    |      |     |    |    |    |      |     |     |    |     |     |  |
| 100000  | .100   | 104PF |    |       |    |    |    |      |    |    |    |    |      |     |    |    |    |      |     |     |    |     |     |  |
| 120000  | .120   | 124PF |    |       |    |    |    |      |    |    |    |    |      |     |    |    |    |      |     |     |    |     |     |  |
| 150000  | .150   | 154PF |    |       |    |    |    |      |    |    |    |    |      |     |    |    |    |      |     |     |    |     |     |  |
| 180000  | .180   | 184PF |    |       |    |    |    |      |    |    |    |    |      |     |    |    |    |      |     |     |    |     |     |  |
| 220000  | .220   | 224PF |    |       |    |    |    |      |    |    |    |    |      |     |    |    |    |      |     |     |    |     |     |  |
| 270000  | .270   | 274PF |    |       |    |    |    |      |    |    |    |    |      |     |    |    |    |      |     |     |    |     |     |  |
| 330000  | .330   | 334PF |    |       |    |    |    |      |    |    |    |    |      |     |    |    |    |      |     |     |    |     |     |  |
| 390000  | .390   | 394PF |    |       |    |    |    |      |    |    |    |    |      |     |    |    |    |      |     |     |    |     |     |  |
| 470000  | .470   | 474PF |    |       |    |    |    |      |    |    |    |    |      |     |    |    |    |      |     |     |    |     |     |  |
| 560000  | .560   | 564PF |    |       |    |    |    |      |    |    |    |    |      |     |    |    |    |      |     |     |    |     |     |  |
| 680000  | .680   | 684PF |    |       |    |    |    |      |    |    |    |    |      |     |    |    |    |      |     |     |    |     |     |  |
| 1000000 | 1.00   | 105PF |    |       |    |    |    |      |    |    |    |    |      |     |    |    |    |      |     |     |    |     |     |  |
| 1200000 | 1.20   | 125PF |    |       |    |    |    |      |    |    |    |    |      |     |    |    |    |      |     |     |    |     |     |  |
| 1500000 | 1.50   | 155PF |    |       |    |    |    |      |    |    |    |    |      |     |    |    |    |      |     |     |    |     |     |  |
| 1800000 | 1.80   | 185PF |    |       |    |    |    |      |    |    |    |    |      |     |    |    |    |      |     |     |    |     |     |  |
| 2200000 | 2.20   | 225PF |    |       |    |    |    |      |    |    |    |    |      |     |    |    |    |      |     |     |    |     |     |  |

\* IR and vapor phase solder only recommended

Capacitance tolerance available: ±10%

## Y5V capacitance voltage availability

| Size               |       |       | 0402* |    | 0603* |    |    | 0805 |    |    |    | 1206 |    |    |    | 1210 |    |
|--------------------|-------|-------|-------|----|-------|----|----|------|----|----|----|------|----|----|----|------|----|
| Capacitance values |       |       | 16    | 50 | 10    | 16 | 25 | 50   | 10 | 16 | 25 | 50   | 10 | 16 | 25 | 50   | 25 |
| pF                 | μF    | Code  |       |    |       |    |    |      |    |    |    |      |    |    |    |      |    |
| 2200               | .0022 | 222PF |       |    |       |    |    |      |    |    |    |      |    |    |    |      |    |
| 2700               | .0027 | 272PF |       |    |       |    |    |      |    |    |    |      |    |    |    |      |    |
| 3300               | .0033 | 332PF |       |    |       |    |    |      |    |    |    |      |    |    |    |      |    |
| 3900               | .0039 | 392PF |       |    |       |    |    |      |    |    |    |      |    |    |    |      |    |
| 4700               | .0047 | 472PF |       |    |       |    |    |      |    |    |    |      |    |    |    |      |    |
| 5600               | .0056 | 562PF |       |    |       |    |    |      |    |    |    |      |    |    |    |      |    |
| 6800               | .0068 | 682PF |       |    |       |    |    |      |    |    |    |      |    |    |    |      |    |
| 8200               | .0082 | 822PF |       |    |       |    |    |      |    |    |    |      |    |    |    |      |    |
| 10000              | .010  | 103PF |       |    |       |    |    |      |    |    |    |      |    |    |    |      |    |
| 12000              | .012  | 123PF |       |    |       |    |    |      |    |    |    |      |    |    |    |      |    |
| 15000              | .015  | 153PF |       |    |       |    |    |      |    |    |    |      |    |    |    |      |    |
| 18000              | .018  | 183PF |       |    |       |    |    |      |    |    |    |      |    |    |    |      |    |
| 22000              | .022  | 223PF |       |    |       |    |    |      |    |    |    |      |    |    |    |      |    |
| 27000              | .027  | 273PF |       |    |       |    |    |      |    |    |    |      |    |    |    |      |    |
| 33000              | .033  | 333PF |       |    |       |    |    |      |    |    |    |      |    |    |    |      |    |
| 39000              | .039  | 393PF |       |    |       |    |    |      |    |    |    |      |    |    |    |      |    |
| 47000              | .047  | 473PF |       |    |       |    |    |      |    |    |    |      |    |    |    |      |    |
| 56000              | .056  | 563PF |       |    |       |    |    |      |    |    |    |      |    |    |    |      |    |
| 68000              | .068  | 683PF |       |    |       |    |    |      |    |    |    |      |    |    |    |      |    |
| 82000              | .082  | 823PF |       |    |       |    |    |      |    |    |    |      |    |    |    |      |    |
| 100000             | .100  | 104PF |       |    |       |    |    |      |    |    |    |      |    |    |    |      |    |
| 120000             | .120  | 124PF |       |    |       |    |    |      |    |    |    |      |    |    |    |      |    |
| 150000             | .150  | 154PF |       |    |       |    |    |      |    |    |    |      |    |    |    |      |    |
| 180000             | .180  | 184PF |       |    |       |    |    |      |    |    |    |      |    |    |    |      |    |
| 220000             | .220  | 224PF |       |    |       |    |    |      |    |    |    |      |    |    |    |      |    |
| 270000             | .270  | 274PF |       |    |       |    |    |      |    |    |    |      |    |    |    |      |    |
| 330000             | .330  | 334PF |       |    |       |    |    |      |    |    |    |      |    |    |    |      |    |
| 390000             | .390  | 394PF |       |    |       |    |    |      |    |    |    |      |    |    |    |      |    |
| 470000             | .470  | 474PF |       |    |       |    |    |      |    |    |    |      |    |    |    |      |    |
| 560000             | .560  | 564PF |       |    |       |    |    |      |    |    |    |      |    |    |    |      |    |
| 680000             | .680  | 684PF |       |    |       |    |    |      |    |    |    |      |    |    |    |      |    |
| 820000             | .820  | 824PF |       |    |       |    |    |      |    |    |    |      |    |    |    |      |    |
| 1000000            | 1.0   | 105PF |       |    |       |    |    |      |    |    |    |      |    |    |    |      |    |
| 1200000            | 1.2   | 125PF |       |    |       |    |    |      |    |    |    |      |    |    |    |      |    |
| 1500000            | 1.5   | 155PF |       |    |       |    |    |      |    |    |    |      |    |    |    |      |    |
| 1800000            | 1.8   | 185PF |       |    |       |    |    |      |    |    |    |      |    |    |    |      |    |
| 2200000            | 2.2   | 225PF |       |    |       |    |    |      |    |    |    |      |    |    |    |      |    |
| 2700000            | 2.7   | 275PF |       |    |       |    |    |      |    |    |    |      |    |    |    |      |    |
| 3300000            | 3.3   | 335PF |       |    |       |    |    |      |    |    |    |      |    |    |    |      |    |
| 3900000            | 3.9   | 395PF |       |    |       |    |    |      |    |    |    |      |    |    |    |      |    |
| 4700000            | 4.7   | 475PF |       |    |       |    |    |      |    |    |    |      |    |    |    |      |    |
| 5600000            | 5.6   | 565PF |       |    |       |    |    |      |    |    |    |      |    |    |    |      |    |
| 6800000            | 6.8   | 685PF |       |    |       |    |    |      |    |    |    |      |    |    |    |      |    |
| 10000000           | 10    | 106PF |       |    |       |    |    |      |    |    |    |      |    |    |    |      |    |

\* IR and vapor phase solder only recommended

Capacitance tolerance available: +80, -20%

## Z5U capacitance voltage availability

| Size                                   | 0603* |    | 0805 | 1206 | 1210 |
|--|-------|----|------|------|------|
| Capacitance values<br>pF    μF    Code | 25    | 50 | 50   | 50   | 50   |
| 2200 .0022 222PF                       |       |    |      |      |      |
| 2700 .0027 272PF                       |       |    |      |      |      |
| 3300 .0033 332PF                       |       |    |      |      |      |
| 3900 .0039 392PF                       |       |    |      |      |      |
| 4700 .0047 472PF                       |       |    |      |      |      |
| 5600 .0056 562PF                       |       |    |      |      |      |
| 6800 .0068 682PF                       |       |    |      |      |      |
| 8200 .0082 822PF                       |       |    |      |      |      |
| 10000 .010 103PF                       |       |    |      |      |      |
| 12000 .012 123PF                       |       |    |      |      |      |
| 15000 .015 153PF                       |       |    |      |      |      |
| 18000 .018 183PF                       |       |    |      |      |      |
| 22000 .022 223PF                       |       |    |      |      |      |
| 27000 .027 273PF                       |       |    |      |      |      |
| 33000 .033 333PF                       |       |    |      |      |      |
| 39000 .039 393PF                       |       |    |      |      |      |
| 47000 .047 473PF                       |       |    |      |      |      |
| 56000 .056 563PF                       |       |    |      |      |      |
| 68000 .068 683PF                       |       |    |      |      |      |
| 82000 .082 823PF                       |       |    |      |      |      |
| 100000 .100 104PF                      |       |    |      |      |      |
| 120000 .120 124PF                      |       |    |      |      |      |
| 150000 .150 154PF                      |       |    |      |      |      |
| 180000 .180 184PF                      |       |    |      |      |      |
| 220000 .220 224PF                      |       |    |      |      |      |
| 270000 .270 274PF                      |       |    |      |      |      |
| 330000 .330 334PF                      |       |    |      |      |      |
| 390000 .390 394PF                      |       |    |      |      |      |
| 470000 .470 474PF                      |       |    |      |      |      |
| 560000 .560 564PF                      |       |    |      |      |      |
| 680000 .680 684PF                      |       |    |      |      |      |
| 820000 .820 824PF                      |       |    |      |      |      |
| 1000000 1.0 105PF                      |       |    |      |      |      |
| 1500000 1.5 155PF                      |       |    |      |      |      |

\* IR and vapor phase solder only recommended

Capacitance tolerance: +80, -20%

