

**Zener Diode Series**

# ZD52XXBN3

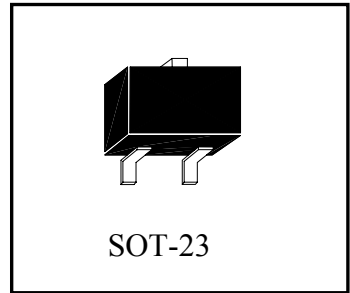

**Thermal Characteristics**

Characteristics	Symbol	Max	Unit
Total Device Dissipation FR-5 Board TA=25°C, Derate above 25°C	PD	225 1.8	mW mW/°C
Total Device Dissipation Alumina Substrate**TA=25°C, Derate above 25°C	PD	300 2.4	mW mW/°C
Thermal Resistance Junction to Ambient	RθJA	417	°C/W
Junction and Storage Temperature	Tj, Tstg	-55 to +150	°C

\*FR-5 - 1.0×0.75×0.062 in. \*\*Alumina - 0.4×0.3×0.024 in. 99.5% alumina.

**Electrical Characteristic** (VF=0.9V Max @IF=10mA for all types.)

Device	Marking Code	Test Current IZT(mA)	Zener Voltage Vz(V)	Zzk Iz=0.25mA (Ω,Max)	ZzT Iz=IZT (Ω,Max)	Max. Reverse Current IR(uA) @VR(V)	
ZD5221B	18A	20	2.4 ±5%	1200	30	100	1.0
ZD5222B	18B	20	2.5 ±5%	1250	30	100	1.0
ZD5223B	18C	20	2.7 ±5%	1300	30	75	1.0
ZD5225B	18E	20	3.0 ±5%	1600	29	50	1.0
ZD5226B	8A	20	3.3 ±5%	1600	28	25	1.0
ZD5227B	8B	20	3.6 ±5%	1700	24	15	1.0
ZD5228B	8C	20	3.9 ±5%	1900	23	10	1.0
ZD5229B	8D	20	4.3 ±5%	2000	22	5.0	1.0
ZD5230B	8E	20	4.7 ±5%	1900	19	5.0	2.0
ZD5231B	8F	20	5.1 ±5%	1600	17	5.0	2.0
ZD5232B	8G	20	5.6 ±5%	1600	11	5.0	3.0
ZD5233B	8H	20	6.0 ±5%	1600	7.0	5.0	3.5
ZD5234B	8J	20	6.2 ±5%	1000	7.0	5.0	4.0
ZD5235B	8K	20	6.8 ±5%	750	5.0	3.0	5.0
ZD5236B	8L	20	7.5 ±5%	500	6.0	3.0	6.0
ZD5237B	8M	20	8.2 ±5%	500	8.0	3.0	6.5
ZD5238B	8N	20	8.7 ±5%	600	8.0	3.0	6.5
ZD5239B	8P	20	9.1 ±5%	600	10	3.0	7.0
ZD5240B	8Q	20	10 ±5%	600	17	3.0	8.0
ZD5241B	8R	20	11 ±5%	600	22	2.0	8.4
ZD5242B	8S	20	12 ±5%	600	30	1.0	9.1
ZD5243B	8T	9.5	13 ±5%	600	13	0.5	9.9
ZD5244B	8U	9.0	14 ±5%	600	15	0.1	10



**Electrical Characteristic(Cont.)**

ZD5245B	8V	8.5	15 ±5%	600	16	0.1	11
ZD5246B	8W	7.8	16 ±5%	600	17	0.1	12
ZD5247B	8X	7.4	17 ±5%	600	19	0.1	13
ZD5248B	8Y	7.0	18 ±5%	600	21	0.1	14
ZD5249B	8Z	6.6	19 ±5%	600	23	0.1	14
ZD5250B	81A	6.2	20 ±5%	600	25	0.1	15
ZD5251B	81B	5.6	22 ±5%	600	29	0.1	17
ZD5252B	81C	5.2	24 ±5%	600	33	0.1	18
ZD5253B	81D	5.0	25 ±5%	600	35	0.1	19
ZD5254B	81E	4.6	27 ±5%	600	41	0.1	21
ZD5255B	81F	4.5	28 ±5%	600	44	0.1	21
ZD5256B	81G	4.2	30 ±5%	600	49	0.1	23
ZD5257B	81H	3.8	33 ±5%	700	58	0.1	25

**Characteristic Curves**

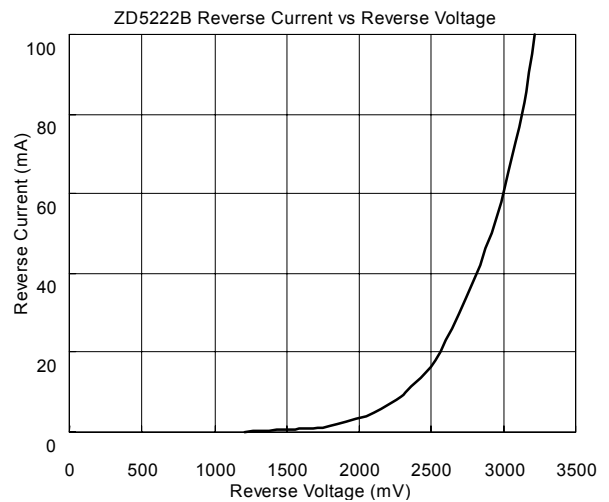
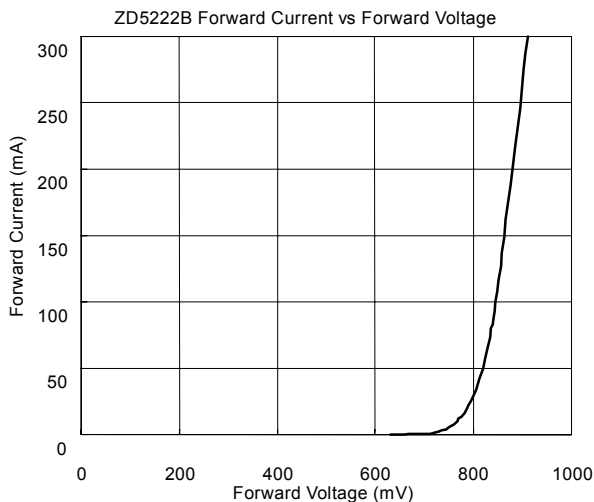
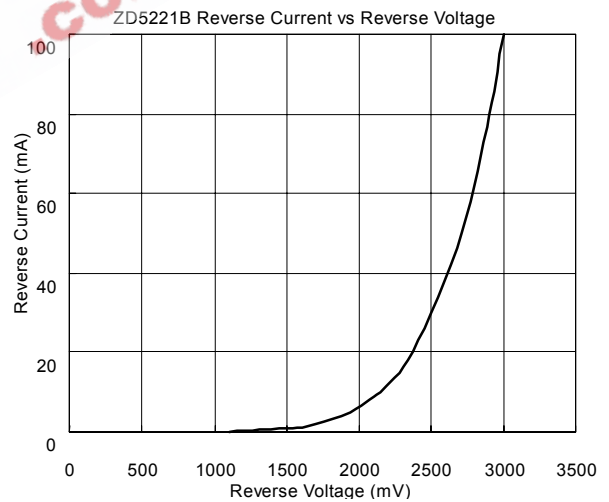
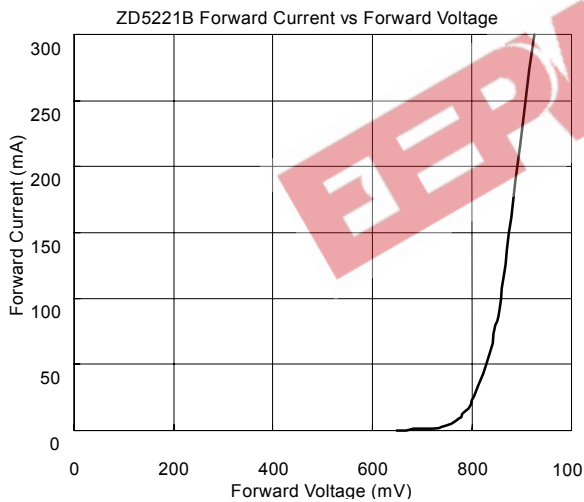

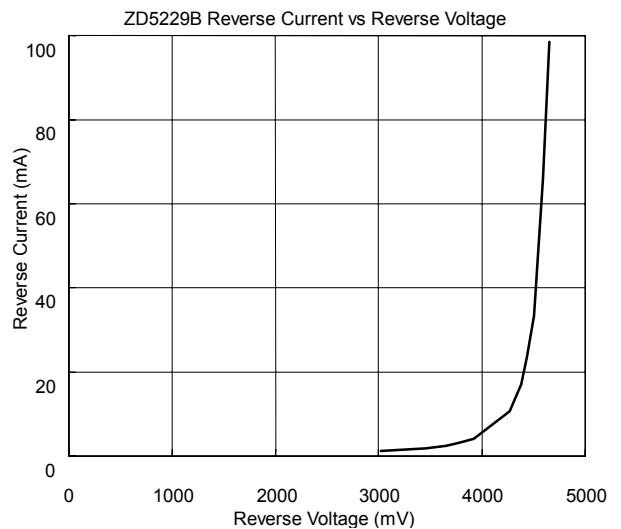
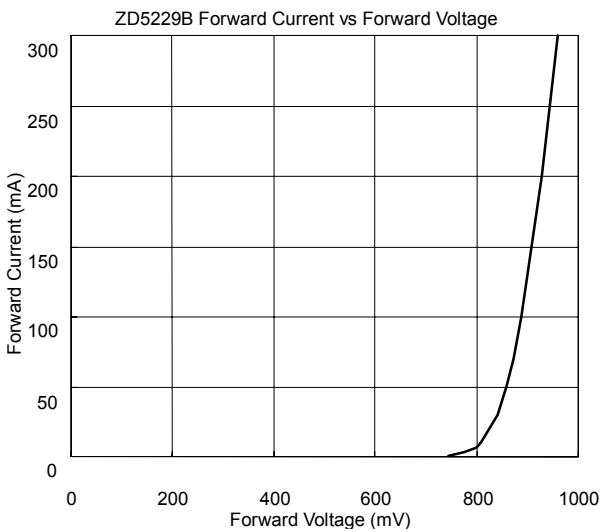
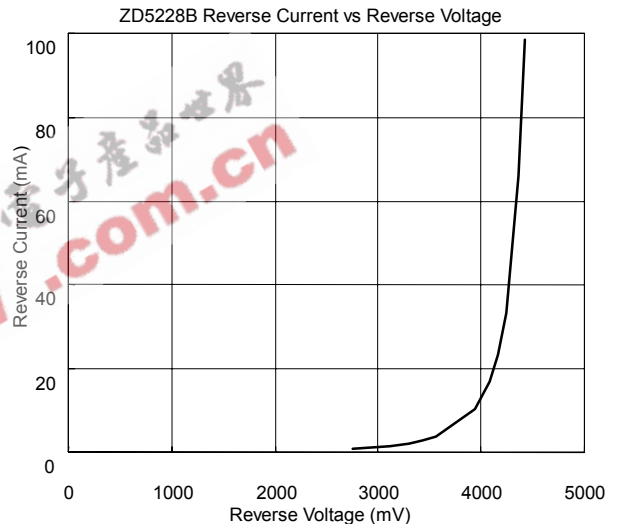
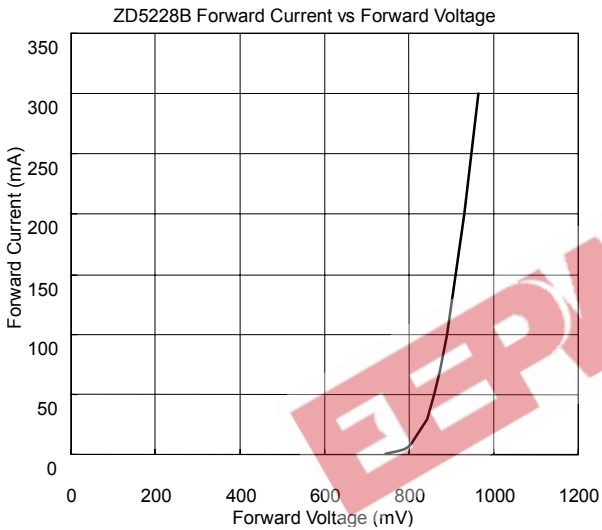
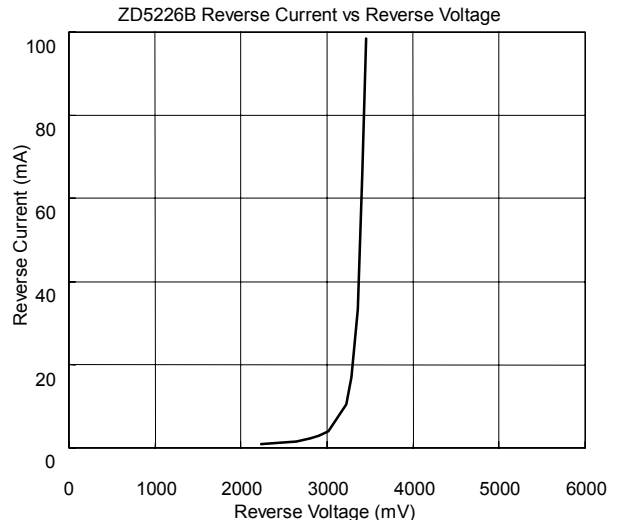
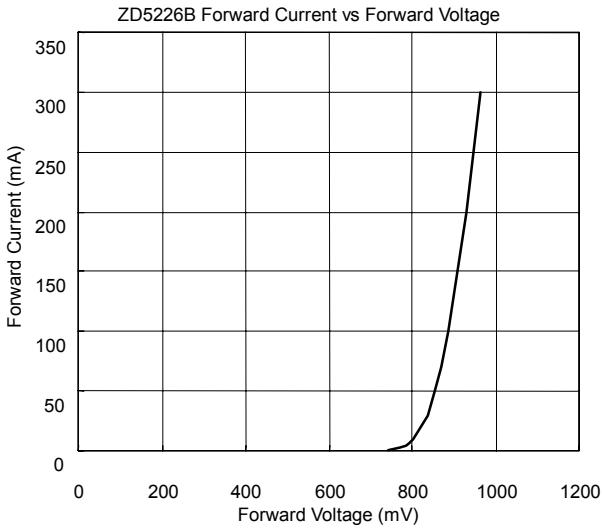

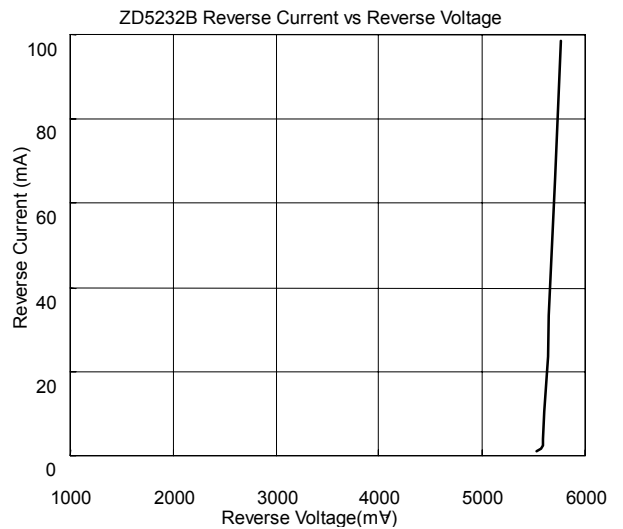
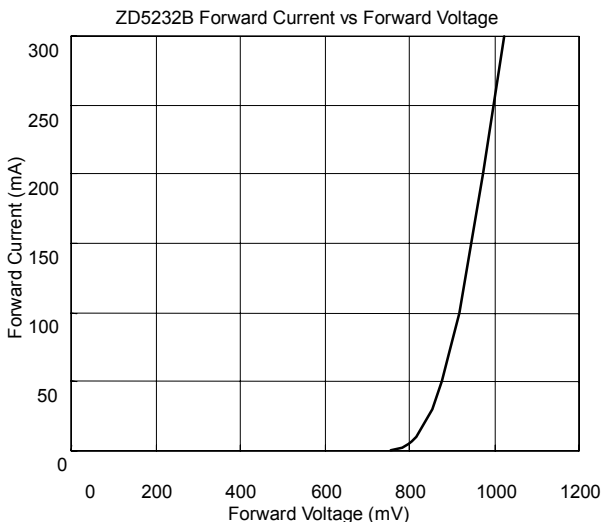
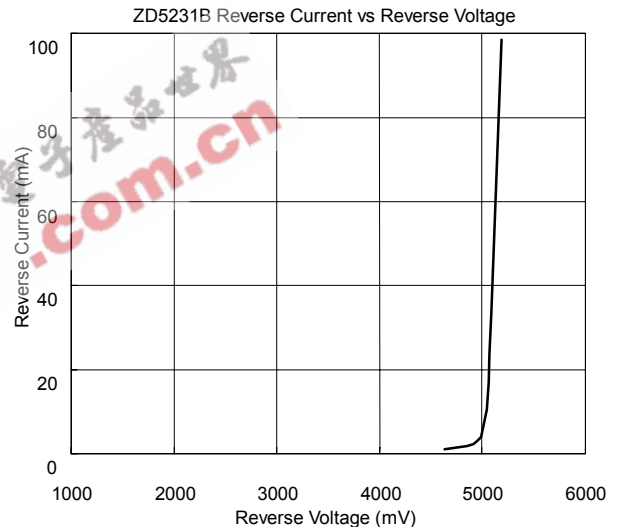
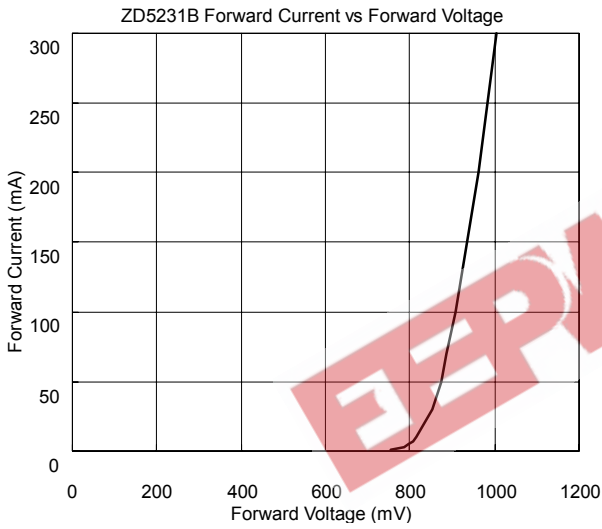
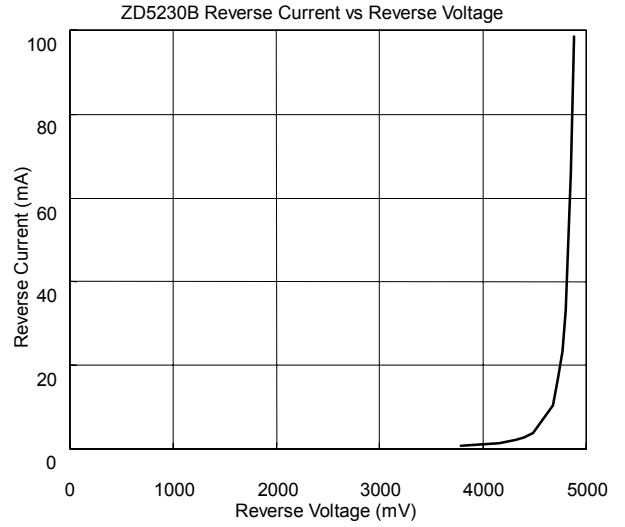
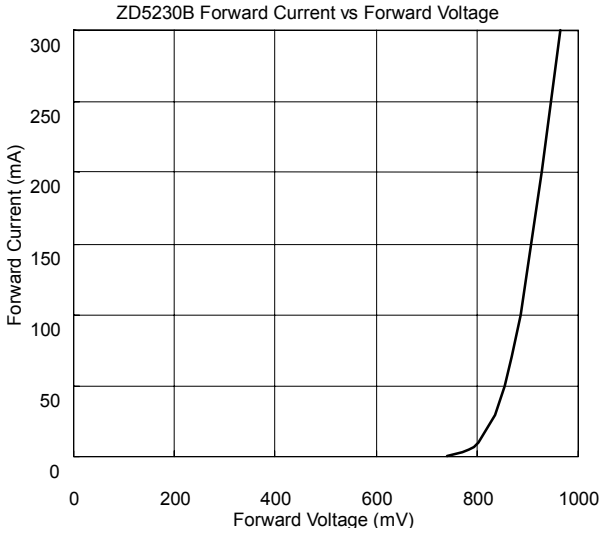

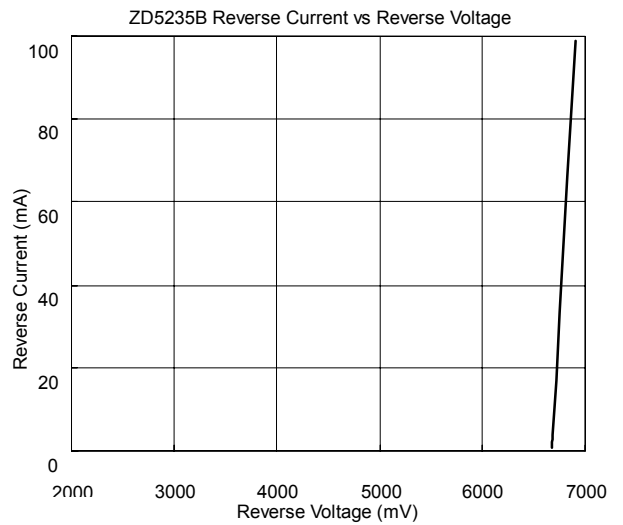
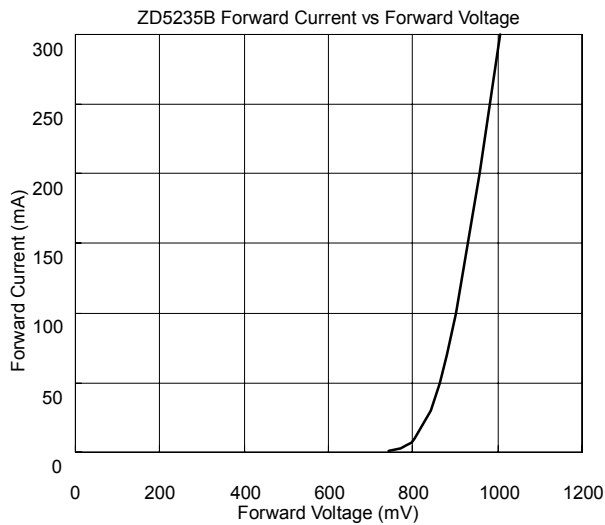
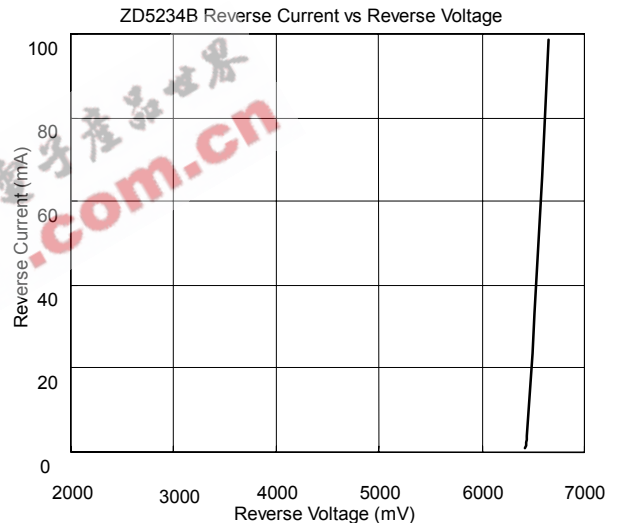
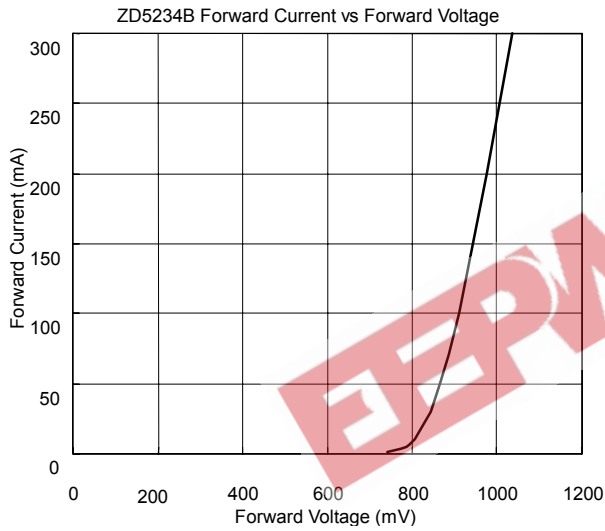
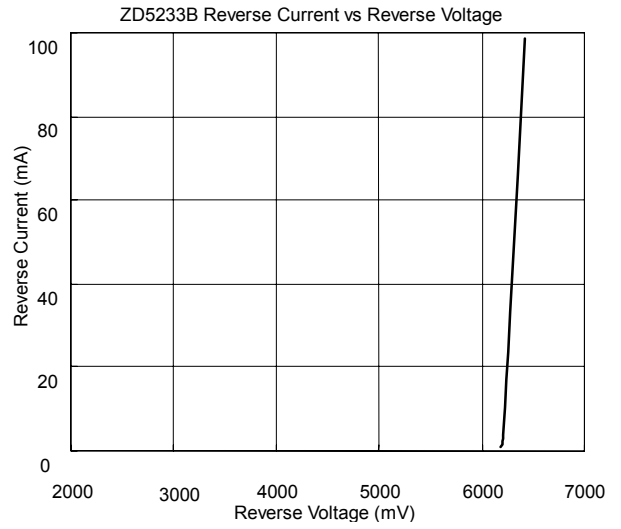
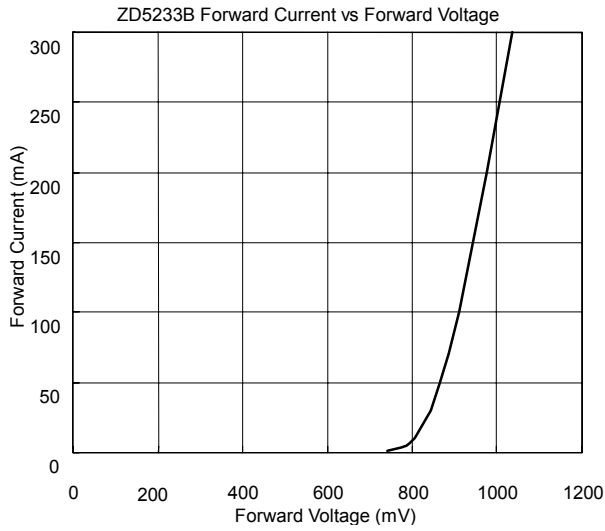

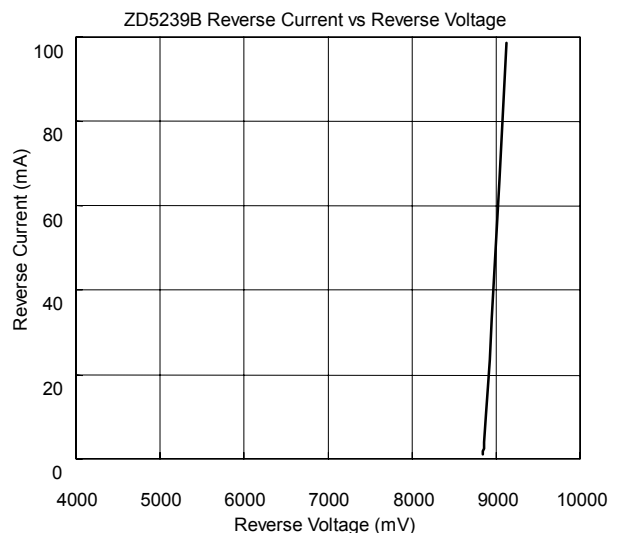
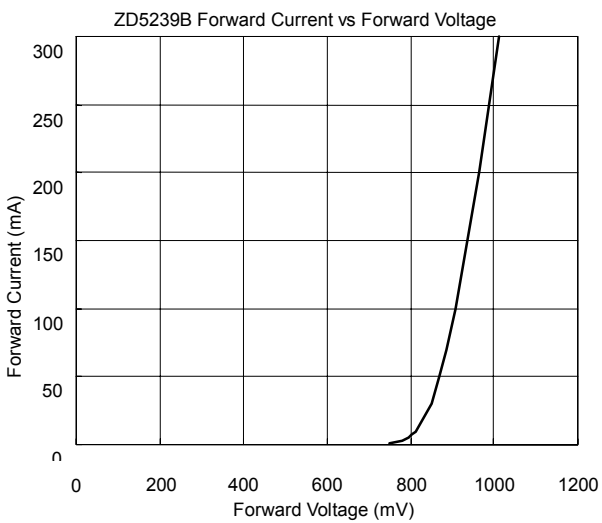
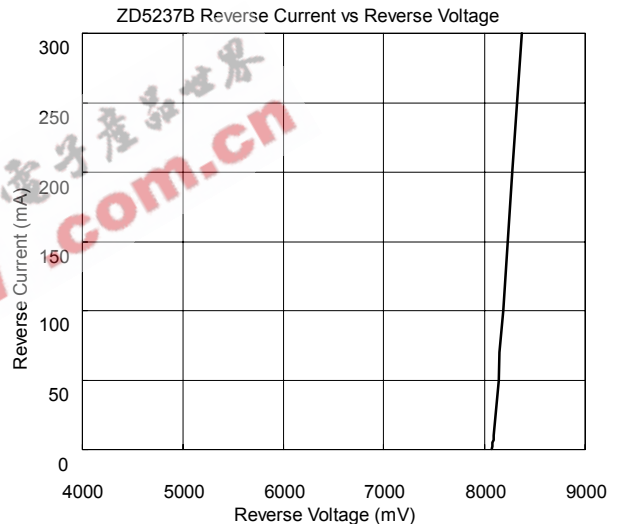
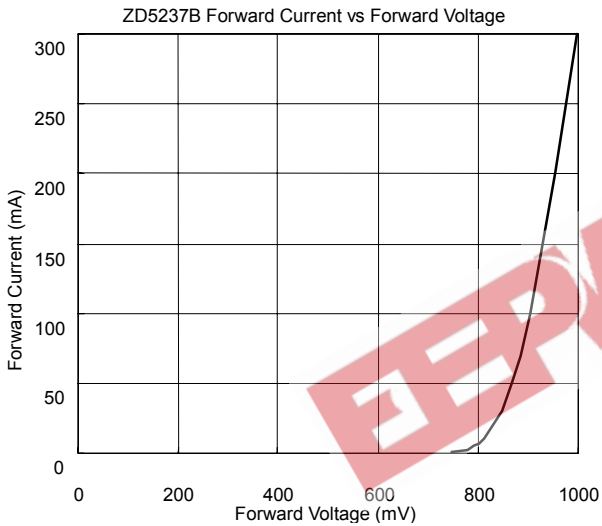
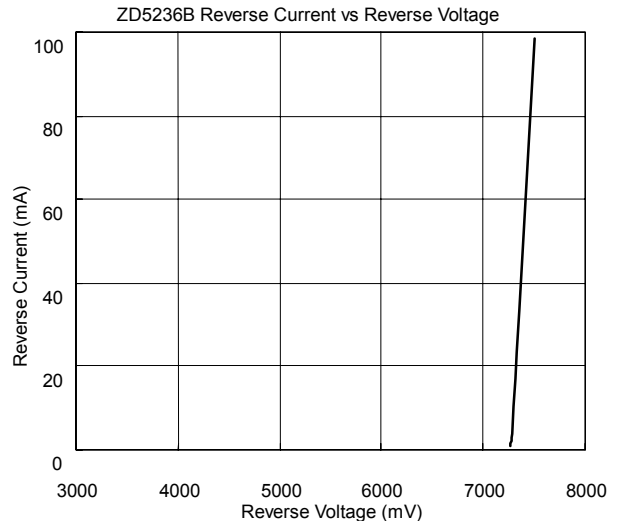
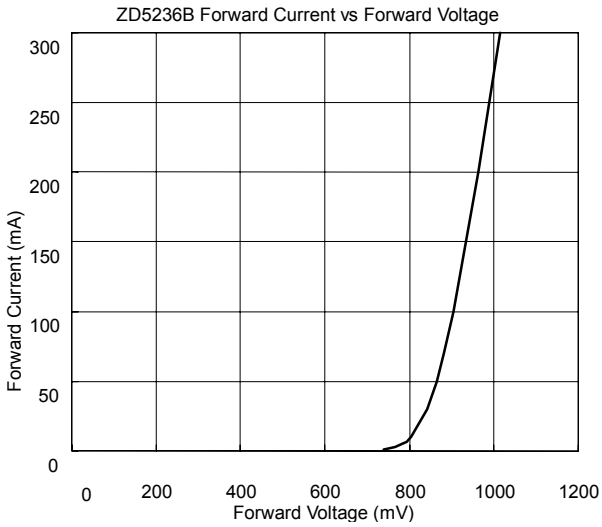

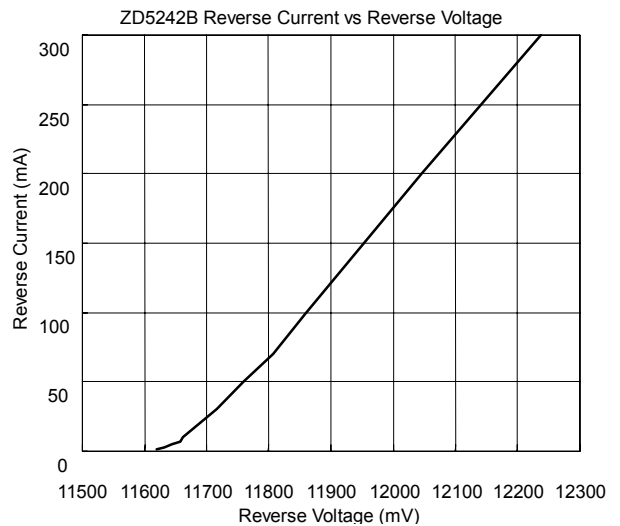
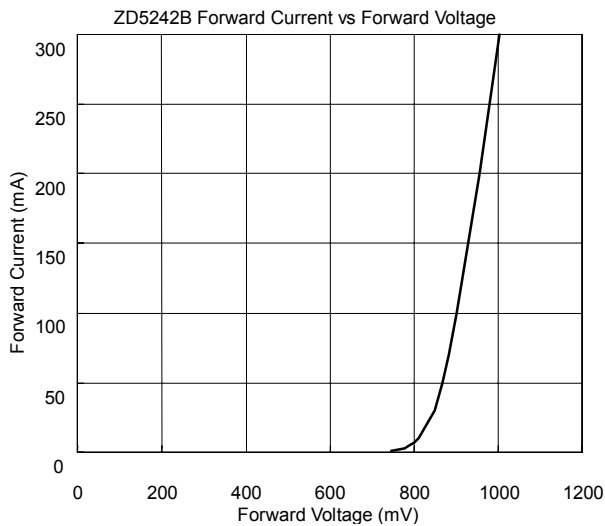
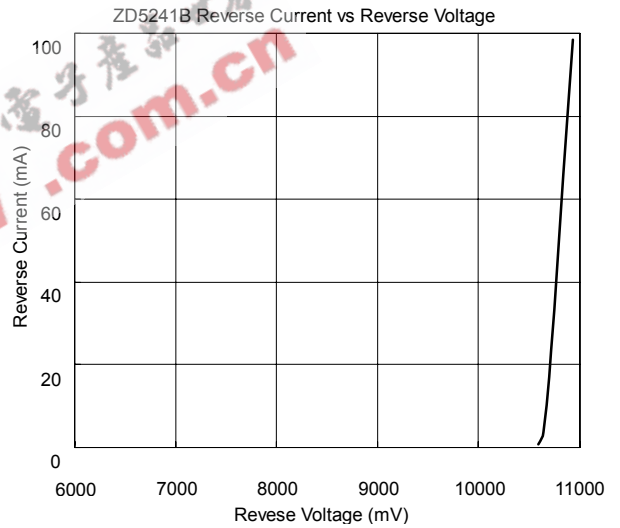
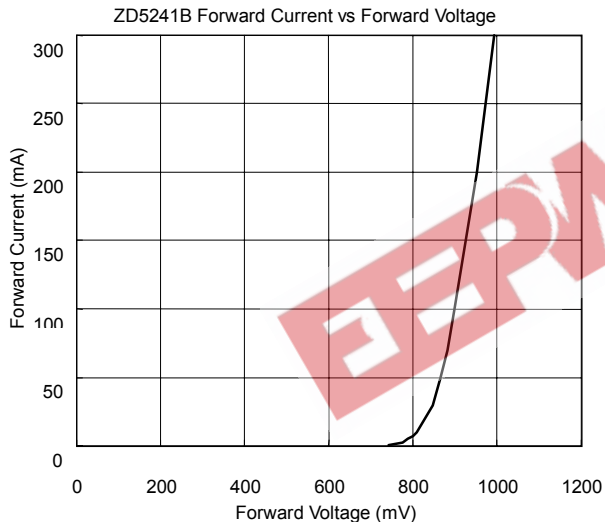
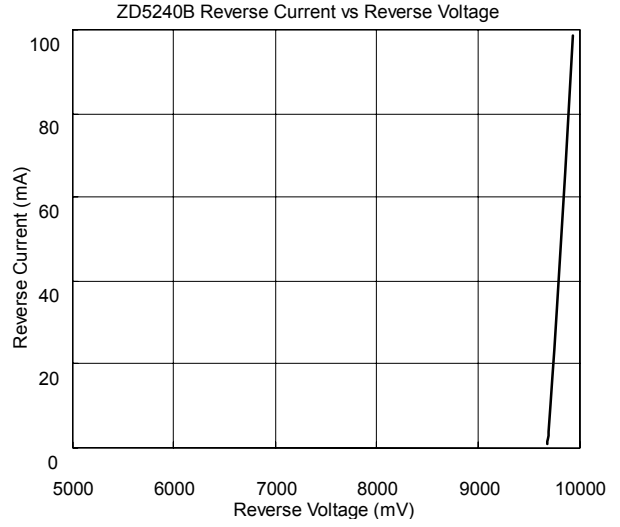
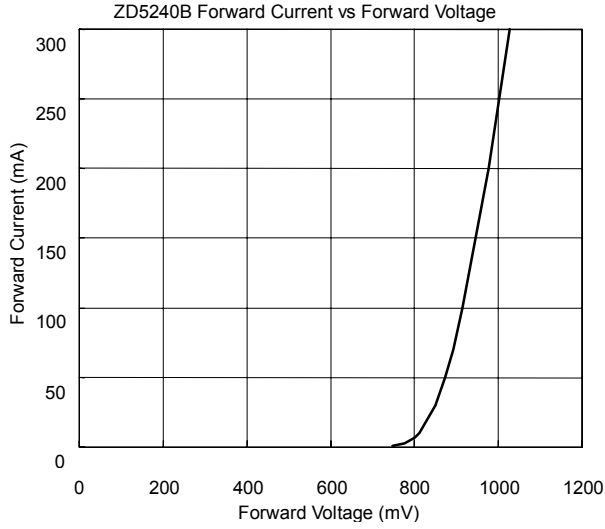

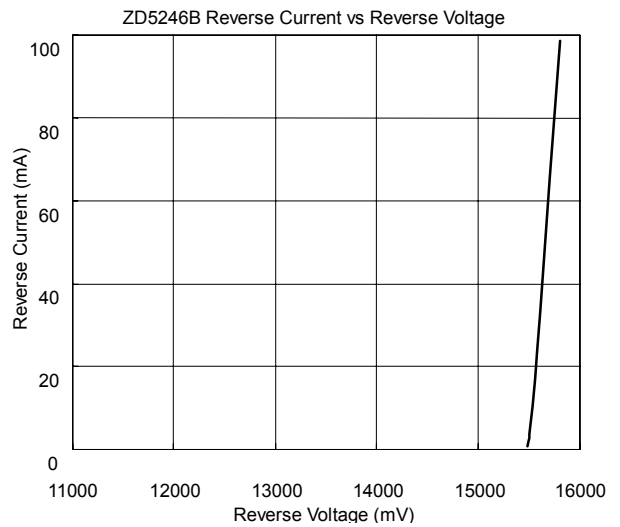
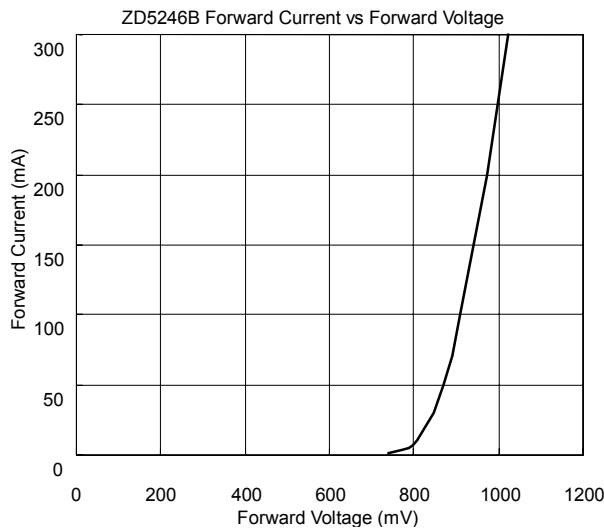
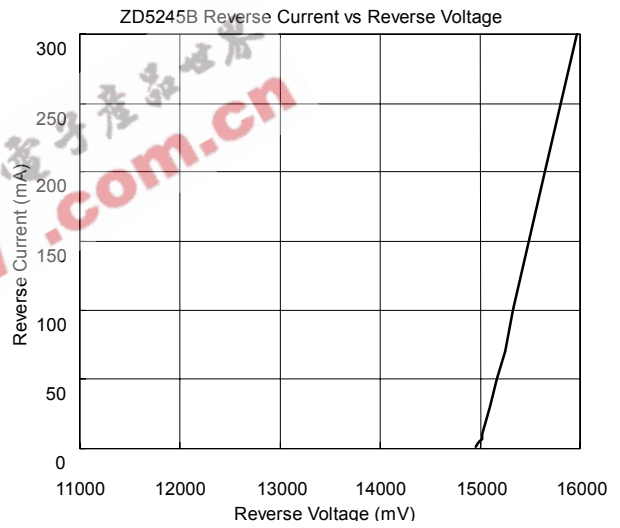
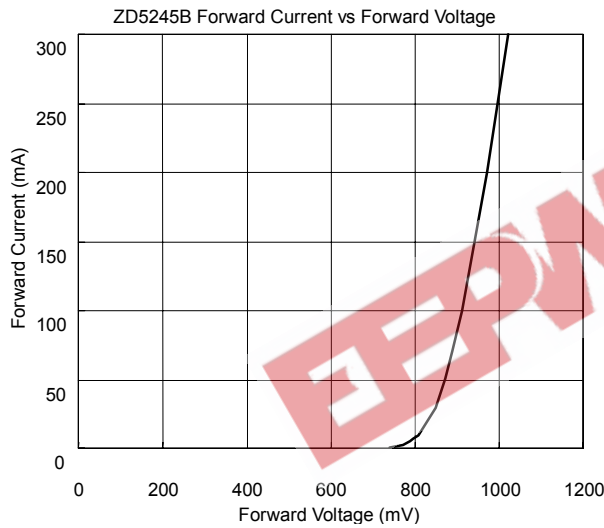
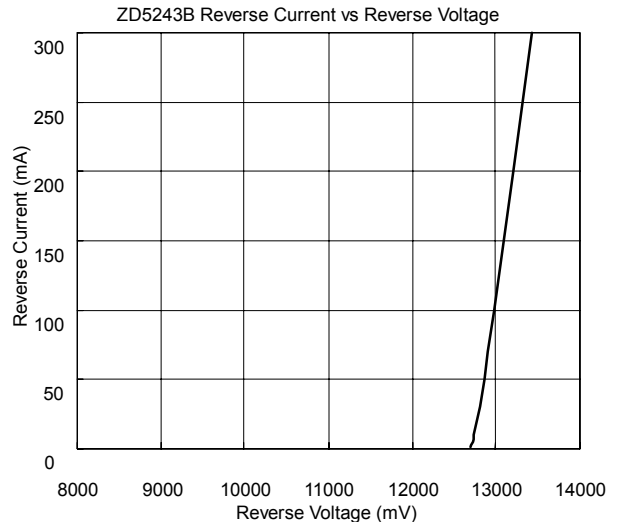
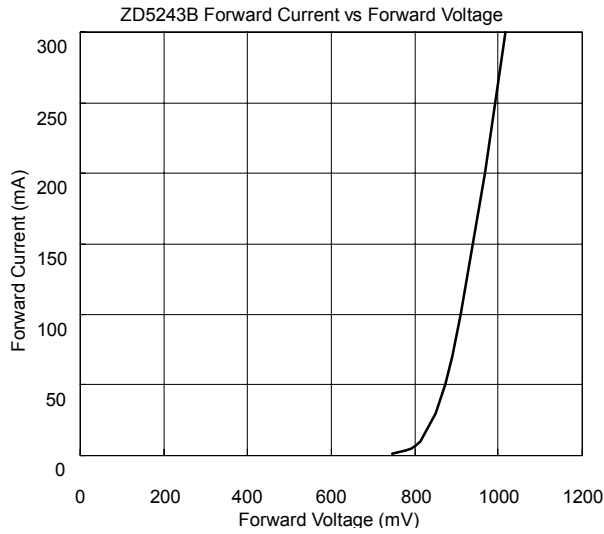



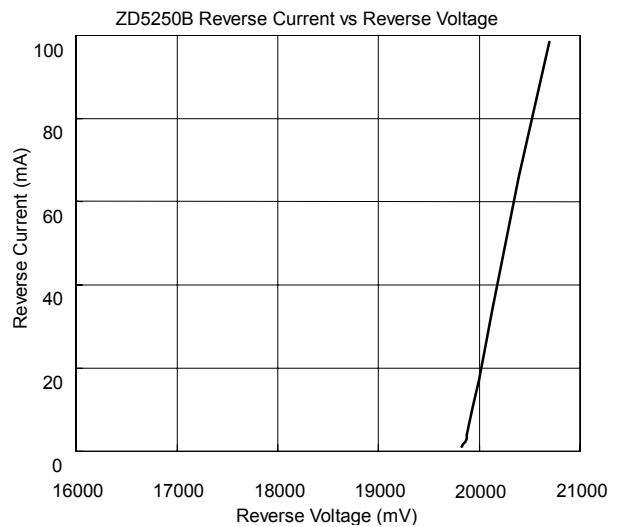
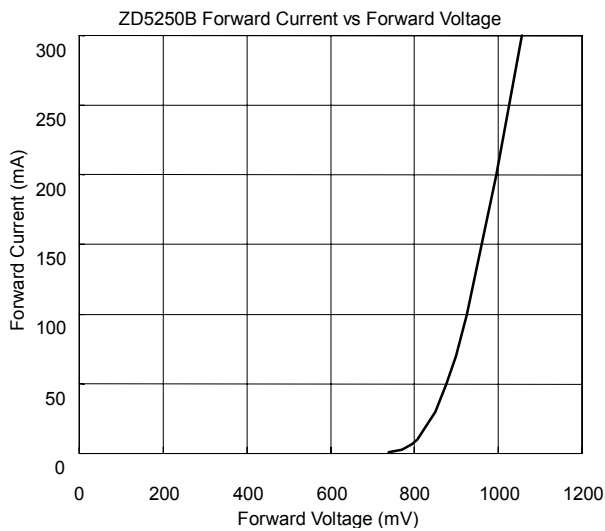
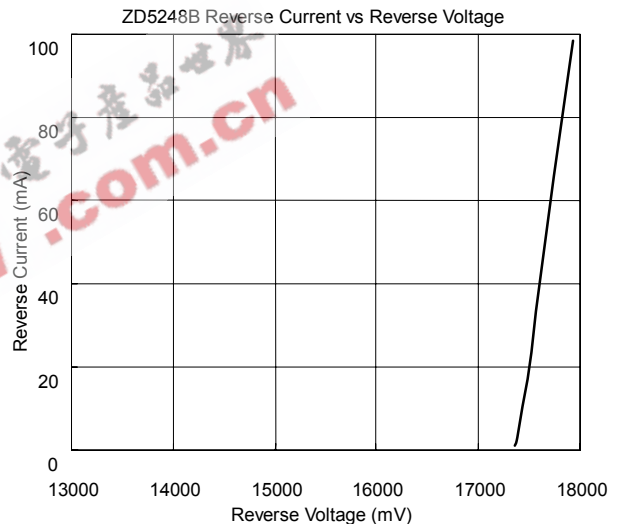
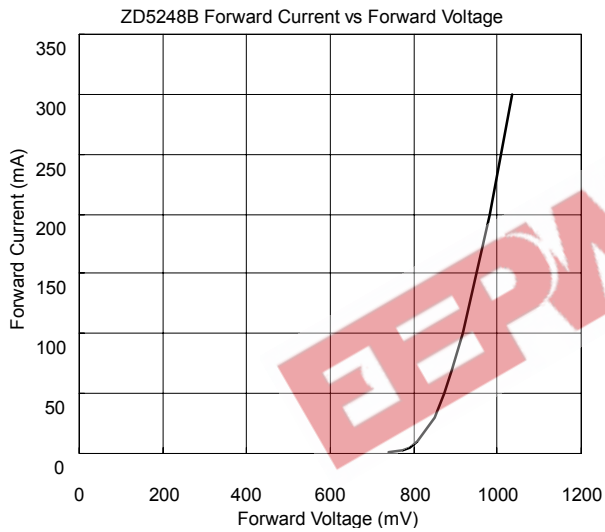
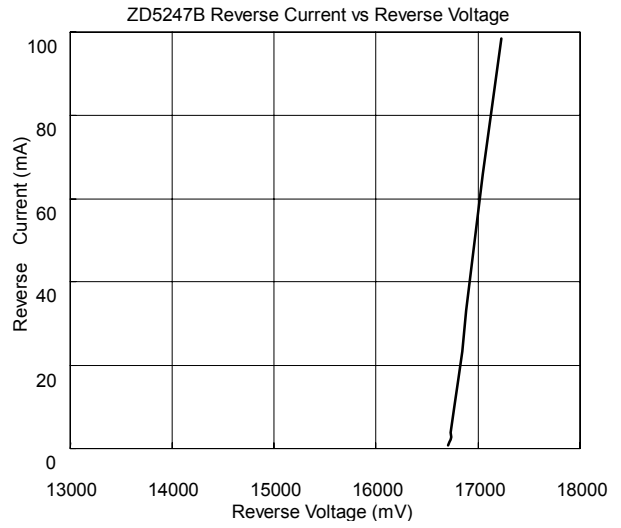
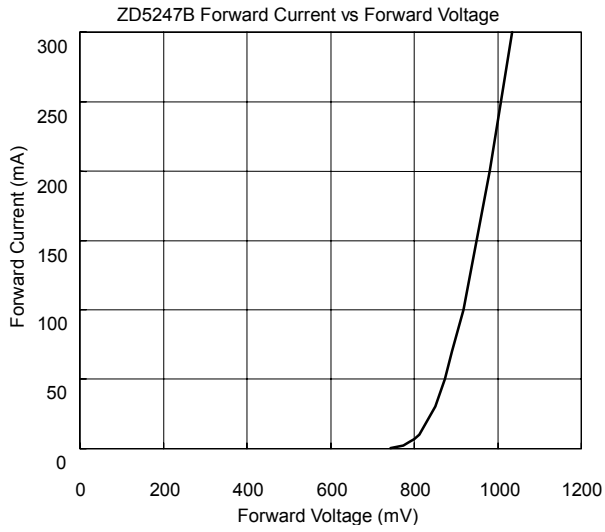

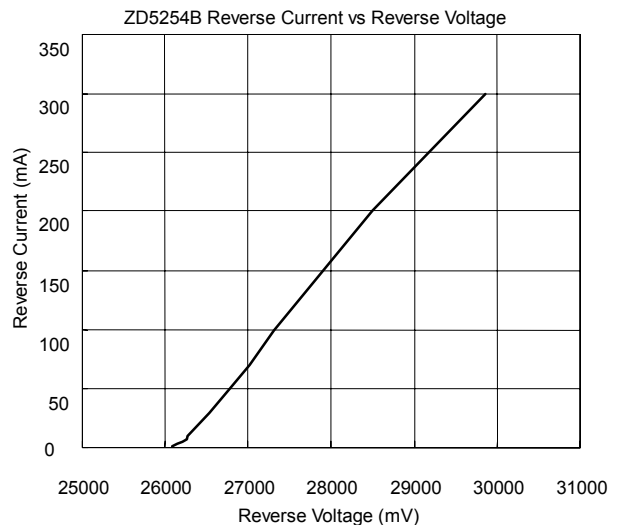
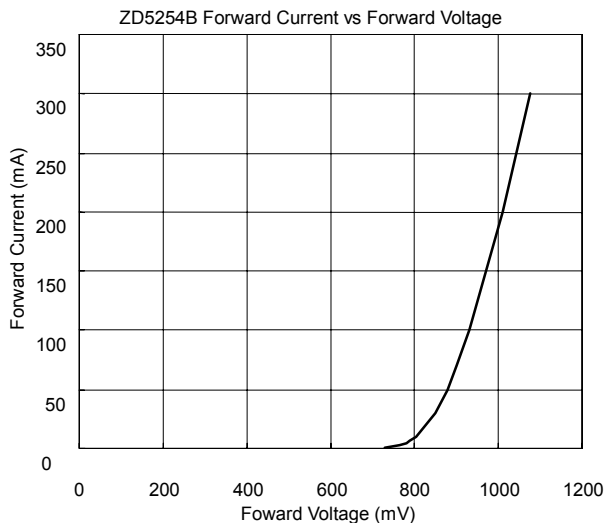
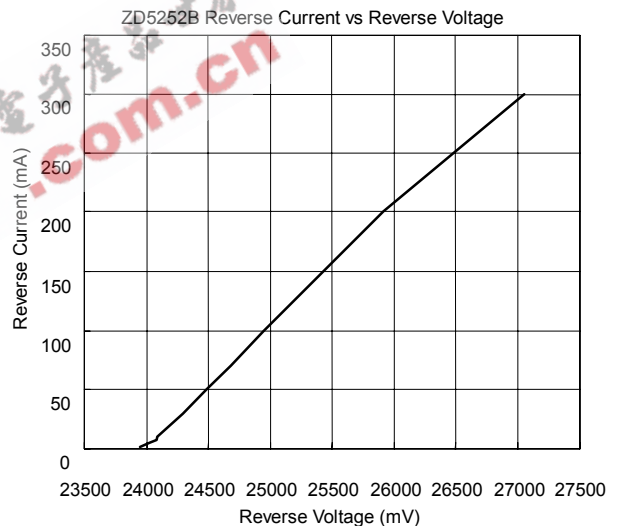
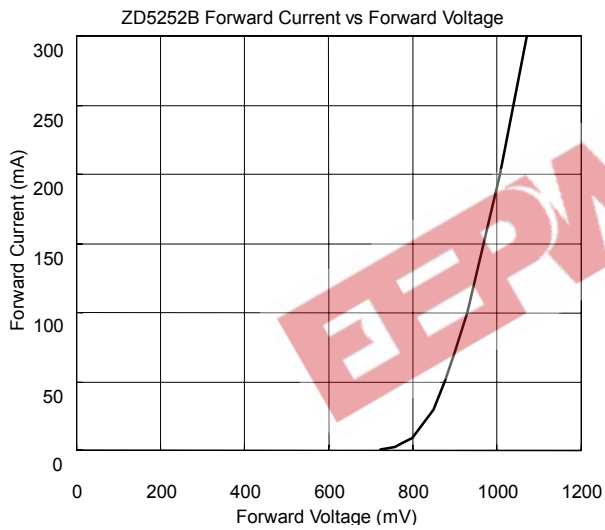
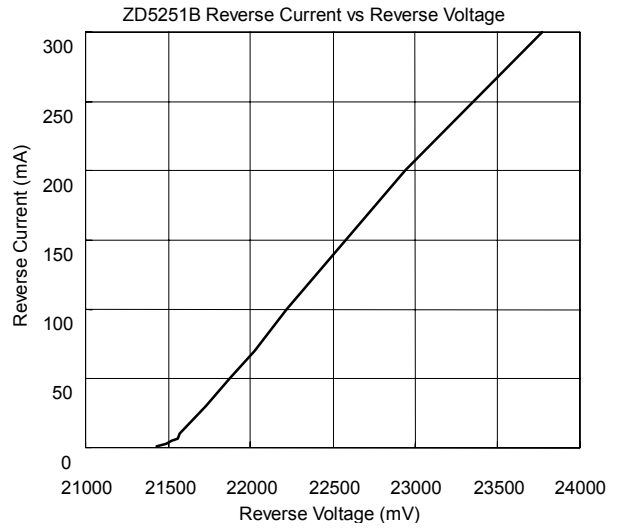
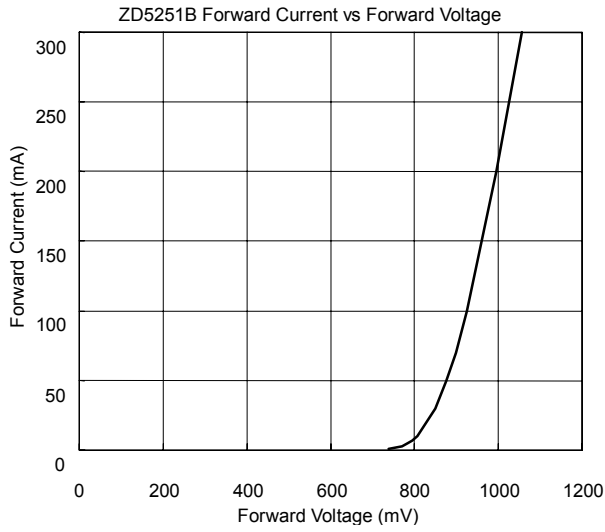

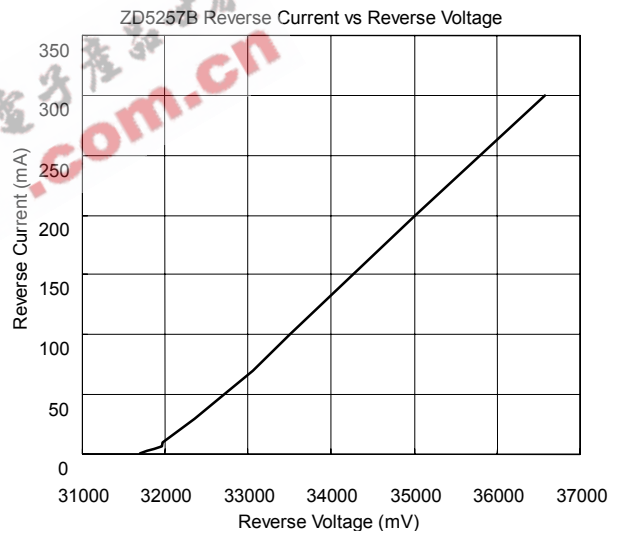
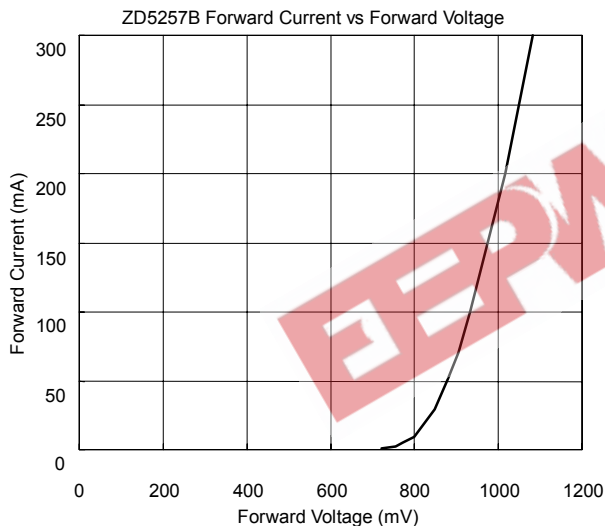
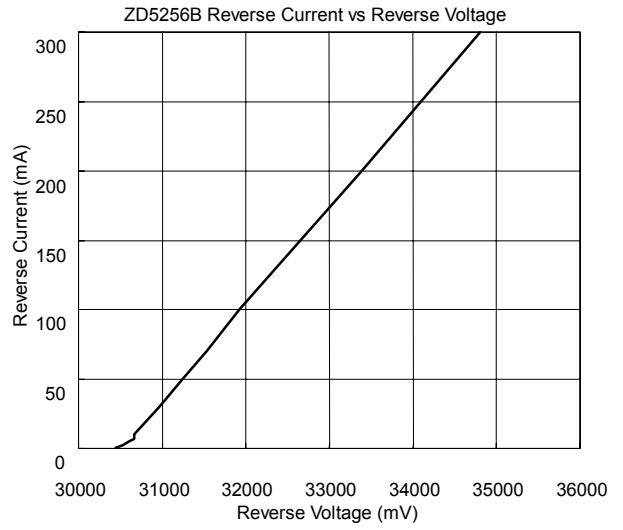
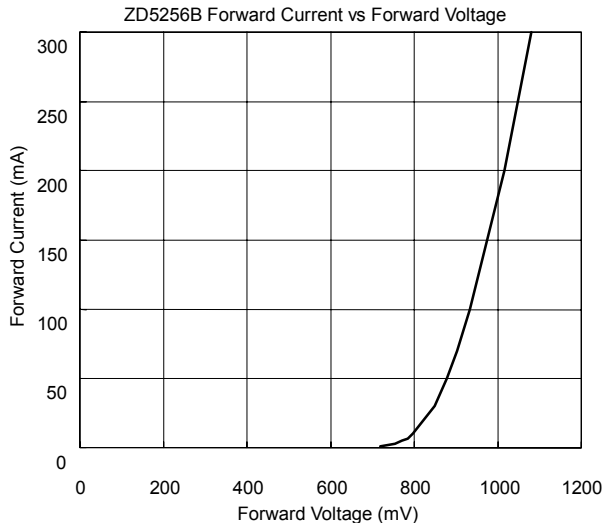

**SOT-23 Dimension**

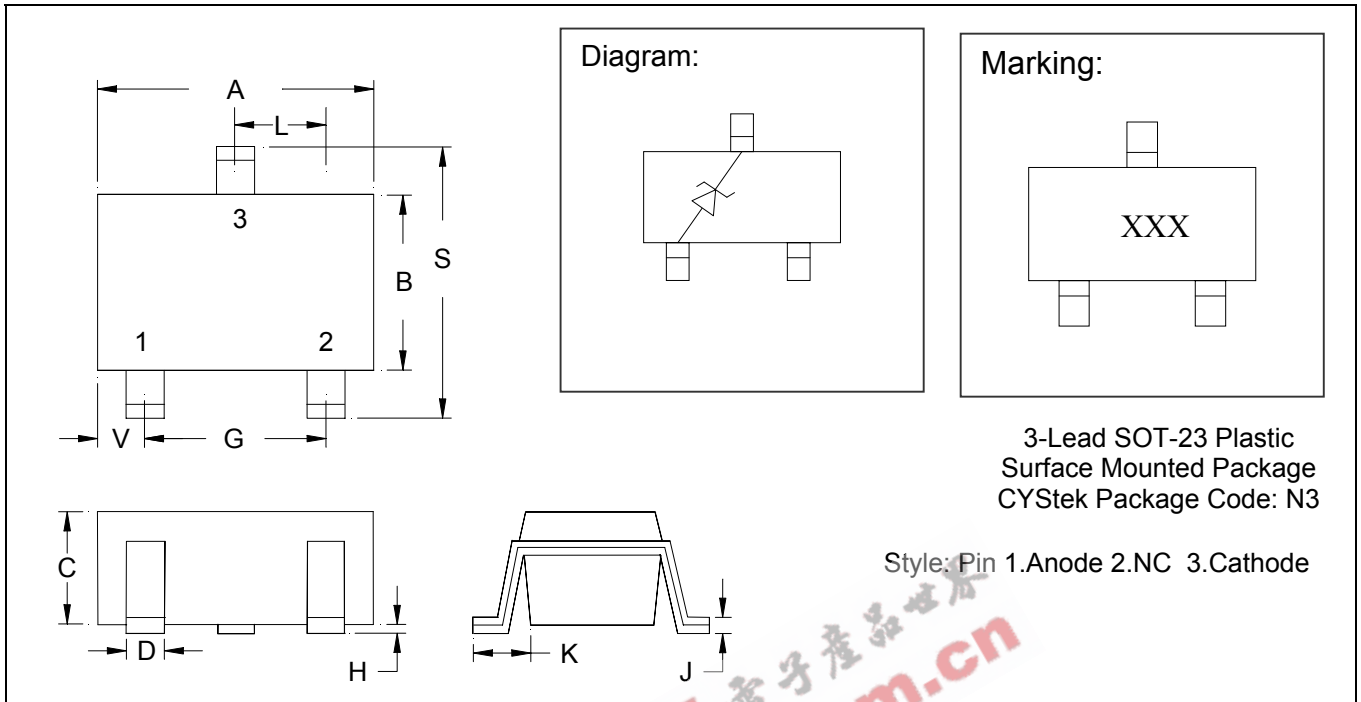

\*: Typical

DIM	Inches		Millimeters		DIM	Inches		Millimeters	
	Min.	Max.	Min.	Max.		Min.	Max.	Min.	Max.
A	0.1102	0.1204	2.80	3.04	J	0.0034	0.0070	0.085	0.177
B	0.0472	0.0630	1.20	1.60	K	0.0128	0.0266	0.32	0.67
C	0.0335	0.0512	0.89	1.30	L	0.0335	0.0453	0.85	1.15
D	0.0118	0.0197	0.30	0.50	S	0.0830	0.1083	2.10	2.75
G	0.0669	0.0910	1.70	2.30	V	0.0098	0.0256	0.25	0.65
H	0.0005	0.0040	0.013	0.10					

**Notes:** 1. Controlling dimension: millimeters.  
 2. Maximum lead thickness includes lead finish thickness, and minimum lead thickness is the minimum thickness of base material.  
 3. If there is any question with packing specification or packing method, please contact your local CYStek sales office.

**Material:**

- Lead: 42 Alloy ; solder plating
- Mold Compound: Epoxy resin family, flammability solid burning class: UL94V-0

**Important Notice:**

- All rights are reserved. Reproduction in whole or in part is prohibited without the prior written approval of CYStek.
- CYStek reserves the right to make changes to its products without notice.
- CYStek **semiconductor products are not warranted to be suitable for use in Life-Support Applications, or systems.**
- CYStek assumes no liability for any consequence of customer product design, infringement of patents, or application assistance.