

# SiBOD™ Series

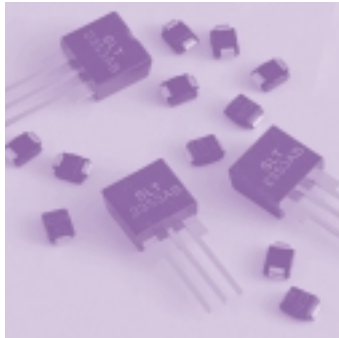

## Thyristors (SiBOD™ Breakover Devices)



 **SiBOD™**  
Series

**CRYDOM**  
Control over power

### Specify Crydom

... for these industry-leading components and products:

- **Solid State Relays**  
Printed Circuit Board Mount  
Panel Mount  
DIN Rail Mount
- **Power Cubes**
- **I/O Modules**
- **Transient Voltage Suppression Components**  
TVS Diodes  
Thyristor Suppression Devices  
Gas Discharge Tubes (GDT)  
Zeners/Studs  
Hybrid Arrester Devices

### Get TVS Insurance From The People Who Know

*There's too much riding on over-voltage surge protection to take chances. That's why more and more people are turning to Crydom.*

#### Why?

To start with, we don't just sell TVS components – we're the only company developing, designing and manufacturing all five of the basic product families: Transient Voltage Suppression (TVS) Diodes. SiBOD™ Thyristor Suppression Devices. Gas Discharge Tubes (GDT). Hybrid Arrester Over-Voltage Surge Protectors. Zeners/Studs. And the only company employing all three voltage protection technologies – gas tube, semiconductor and hybrid.

That means we're the only one who knows them inside and out. What each type can and can't do. Which type to use for different applications. How to provide as much or little technical support as you need. How to work with you to develop special devices should you require them. And even assist you in formulating design requirements and testing procedures to meet both your specifications and international standards.

### Crydom's SiBOD Series Equals "Crow Bar" Protection

*To protect sensitive telecommunications circuitry, Crydom Thyristors (SiBOD™ Breakover Devices) "crow bar" potentially dangerous transients – switching them to ground and dissipating the voltage to zero. This approach can handle more energy than TVS diode "clamping."*

#### FEATURES

- Glass passivated junction
- Bi-directional transient voltage protection
- Nano second clamping response
- Surge capability up to 500 amps
- No performance degradation under service life

#### BENEFITS

- One component cost for +ve and -ve protection
- Excellent voltage protection levels
- Can be used for primary or secondary protection
- No replacement required ie, no maintenance cost
- Highest level of quality and reliability
- Low cost auto assembly

#### MECHANICAL CHARACTERISTICS

- Transfer molded, void free epoxy body
- Tin/Lead plated leads
- Maximum case temperature for soldering purposes: 230°C for 10 seconds

**Thyristors (SiBOD™ Breakover Devices)**

**SiBOD Series  
Application Notes**

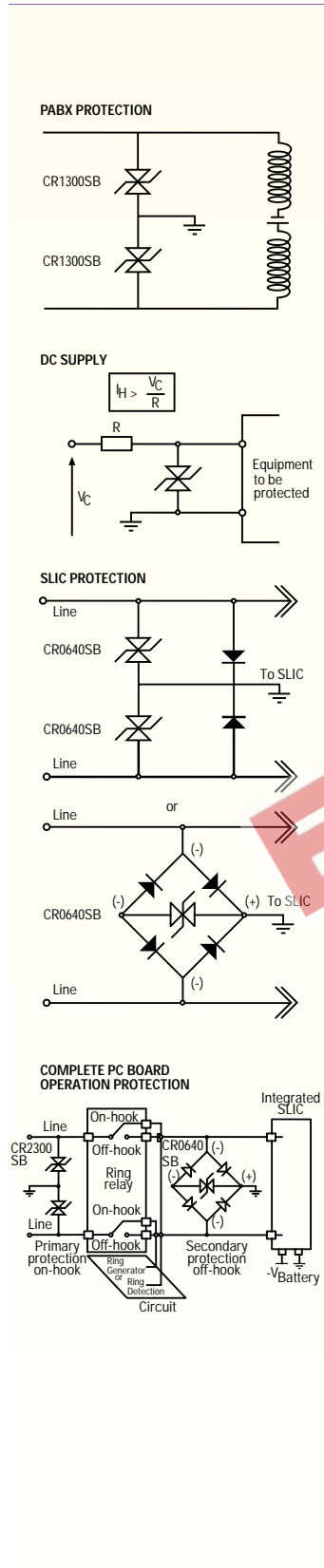

*The Added Crydom Benefit*  
Crydom Thyristors (SiBOD™ Breakover Devices) offer the highest quality and performance. They also come with an added benefit – service and technical assistance to help ensure optimum protection for your telecommunications application.

**SiBOD Series**

The Crydom SiBOD is a four-layer thyristor-based protector designed specifically for telecommunications applications. It has greater capacity for diverting surge currents than an avalanche TVS device.

The Crydom series protector is based on the proven technology of the SiBOD product. Designed for transient voltage protection of telecommunications equipment, it provides higher power handling than a conventional avalanche diode (TVS), and when compared to a GDT offers lower voltage clamping levels and infinite surge life.

**Electrical Characteristics**

The electrical characteristics of the SiBOD devices are similar to those of a self-gated Triac, but the SiBOD are two-terminal devices with no gate. The gate function is achieved by an internal current controlled mechanism.

Like the TVS diodes, the SiBOD have a stand-off voltage (V<sub>RM</sub>) that should be equal to or greater than the operating voltage of the system to be protected. At this voltage (V<sub>RM</sub>) the current consumption of the SiBOD are negligible and will not effect the protected system.

When a transient occurs, the voltage across the SiBOD will increase until the breakdown voltage (V<sub>BR</sub>) is reached. At this point the device will operate in a similar way to a TVS device and is in an avalanche mode.

The voltage of the transient will now be limited and will only increase by a few volts as the device diverts more current. As this transient current rises, a level of current through the device is reached (I<sub>BO</sub>), causing the device to switch to a fully conductive state such that the voltage across the device is now only a few volts (V<sub>T</sub>). The voltage at which the device switches from the avalanche mode to the fully conductive state (V<sub>T</sub>) is known as the breakover voltage (V<sub>BO</sub>). When the device is in the V<sub>T</sub> state, high currents can be diverted without damage to the SiBOD due to the low voltage across the device, since the limiting factor in such devices is dissipated power (V X I).

Resetting of the device to the nonconducting state is controlled by the current flowing through the device. When the current falls below a certain value, known as the holding current (I<sub>H</sub>), the device resets automatically.

As with the avalanche TVS device, if the SiBOD device is subjected to a surge current that is beyond its maximum rating, the device will fail in short-circuit mode, which ensures that the equipment is ultimately protected.

# SiBOD Series Application Notes



## Selecting a SiBOD Device

- When selecting a device, it is important that the  $V_{RM}$  of the device be equal to or greater than the operating voltage of the system. For example, when protecting the ringing circuit of a telephone handset, SiBOD  $V_{RM} > V_{DC} + \text{RINGING VOLTAGE}$   
SiBOD  $V_{RM} > V_{DC} + \sqrt{2} \times \text{RINGING VOLTAGE}$
- The minimum holding current ( $I_H$ ) of the device must be carefully selected if the SiBOD is to reset after diverting a surge. The minimum  $I_H$  value of the SiBOD must be greater than the current the system is capable of delivering, otherwise the device will remain conducting following a transient condition.

$$I_H > \frac{\text{SYSTEM VOLTAGE}}{\text{SOURCE IMPEDANCE}}$$

## The SiBOD range can be used to protect against surges as defined in the following International Standards

| Standard             | VOLTAGE VOLTS | WAVEFORM $\mu\text{SEC}$ | CURRENT AMPS | WAVEFORM $\mu\text{SEC}$ | SiBOD SERIES |
|----------------------|---------------|--------------------------|--------------|--------------------------|--------------|
| FCC Part 68          |               |                          |              |                          |              |
| Surge A Metallic     | 800           | 10x560                   | 100          | 10x560                   | B or C       |
| Surge A Longitudinal | 1500          | 10x160                   | 200          | 10x160                   | C            |
| Surge B Metallic     | 1000          | 9x720                    | 25           | 5x320                    | A, B or C    |
| Surge B Longitudinal | 1500          | 9x720                    | 37.5         | 5x320                    | A, B or C    |
| Bellcore GR 1089     |               |                          |              |                          |              |
| 1                    | 600           | 10x1000                  | 100          | 10x1000                  | C            |
| 2                    | 1000          | 10x360                   | 100          | 10x360                   | B or C       |
| 3                    | 1000          | 10x1000                  | 100          | 10x1000                  | C            |
| 4                    | 2500          | 2x10                     | 500          | 2x10                     | C            |
| 5                    | 1000          | 10x360                   | 25           | 10x360                   | A, B or C    |
| ITU K.17             | 1500          | 10x700                   | 37.5         | 5x310                    | A, B or C    |
| ITU K.20             | 1000          | 10x700                   | 25/100       | 5x310                    | A, B or C    |
| ITU K.21             | 1500          | 10x700                   | 37.5         | 5x310                    | A, B or C    |
|                      | 4000          | 10x700                   | 100          | 5x310                    | B or C       |
| RLM 88, CNET         | 1500          | .5x700                   | 38           | .2x310                   | A, B or C    |
| CNET 131-24          | 1000          | .5x700                   | 25           | .8x310                   | A, B or C    |
| VDE 0433             | 2000          | 10x700                   | 50           | 5x310                    | A, B or C    |
| VDE 0878             | 2000          | 1.2x50                   | 50           | 1x20                     | A, B or C    |
| IEC 61000-4-5        | Level 3       | 10x700                   | 50           | 5x310                    | A, B or C    |
|                      | Level 4       | 1.2x50                   | 100          | 8x20                     | A, B or C    |
| FTZ R12              | 2000          | 10x700                   | 50           | 5x310                    | A, B or C    |

## Thyristors (SiBOD™ Breakover Devices)

### SiBOD Series

V-I Graph Illustrating Symbols and Terms for the SiBOD Surge Protection Devices

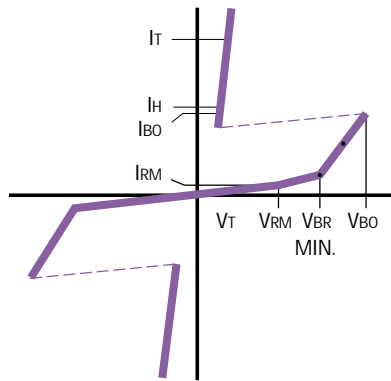

#### ELECTRICAL CHARACTERISTICS (Tj = 25°C)

| SYMBOL                          | PARAMETER             |
|---------------------------------|-----------------------|
| V <sub>RM</sub>                 | Stand-off voltage     |
| V <sub>BR</sub>                 | Breakdown voltage     |
| V <sub>BO</sub> /V <sub>s</sub> | Breakover voltage     |
| V <sub>T</sub>                  | On-state voltage      |
| I <sub>RM</sub>                 | Stand-off current     |
| I <sub>BO</sub>                 | Breakover current     |
| I <sub>H</sub>                  | Holding current       |
| C <sub>o</sub>                  | Off state Capacitance |
| I <sub>pp</sub>                 | Peak pulse current    |

Typical V<sub>BO</sub> Change vs. Junction Temperature

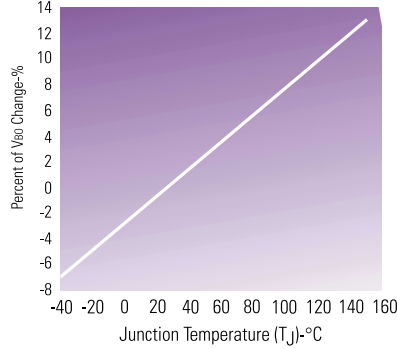

Typical DC Holding Current vs. Case Temperature

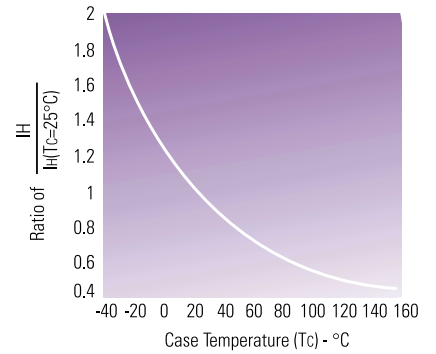

Pulse Wave Form (10/1000 μs)

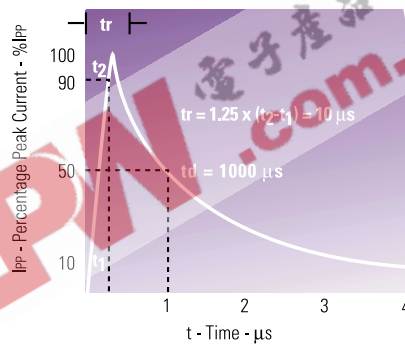

1.2/50 μs Impulse Discharge Voltage Waveshape

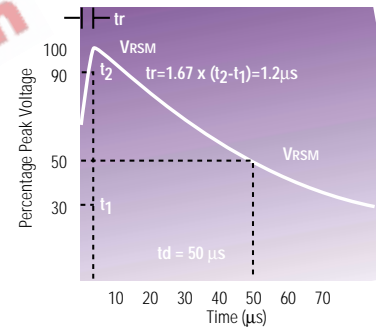

8/20 μs Impulse Discharge Current Waveshape

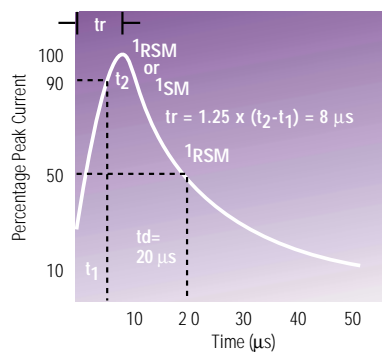

#### ABSOLUTE RATINGS

| SYMBOL           | PARAMETER   | VALUE      |            |            | UNIT |
|------------------|---|------------|------------|------------|------|
|                  |   | DO-214     | TO-220     | T10        |      |
| T <sub>stg</sub> | Storage and operating junction temperature range                  | -40 to 150 | -40 to 150 | -40 to 150 | °C   |
| T <sub>j</sub>   |   | 150        | 150        | 150        | °C   |
| T <sub>L</sub>   | Maximum temperature for soldering (For period of 10 seconds max.) | 230        | 230        | 230        | °C   |
| T <sub>c</sub>   | Maximum case temperature  | 75         | 115        | 75         | °C   |



DO-214

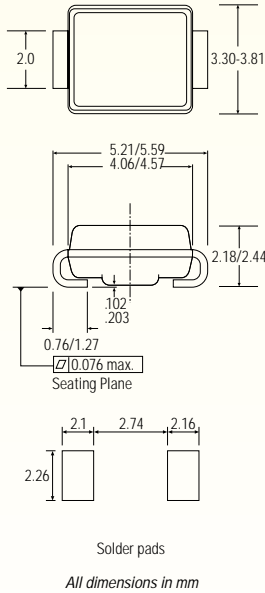

TAPE & REEL PACKAGING

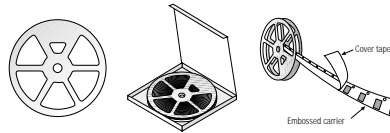

| JEDEC CASE TYPE | TAPE WIDTH (mm) | QUANTITY PER REEL 330mm Reel (øD) (T3) |
|-----------------|-----------------|--|
| DO-214AA        | 12              | 3000                                   |

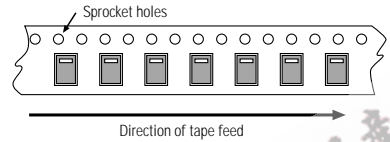

Our surface-mount components are placed in embossed cavities of anti-static/conductive carrier tape and sealed with a cover tape. The taped devices are supplied in reels in protective boxes. The standard Crydom lead-tape packaging of surface-mount components follow the requirements of EIA 481-1, shown below:

- Cover Tape: This will not extend over the edge of the carrier tape or extend over any part of the sprocket holes.
- Carrier Tape: This will release from the reel hub as the last portion of the tape unwinds from the reel without damage to the carrier tape and with the components remaining in the cavities.
- Leader Tape: A minimum length of 300mm leader (and trailer) of tape will be provided before the first (and after the last) component on the reel, with a minimum of forty empty component carrier pockets covered with tape.

Electrical Characteristics

| Stock Number      | Device Code    | Reverse Stand-off Voltage ( $V_R$ ) | Maximum Breakover Voltage ( $V_{BO}$ ) @ $I_{BO}$ | Maximum Voltage Turnon ( $V_T$ ) @ 1A | Maximum Reverse Leakage ( $I_R$ ) @ $V_R$ | Maximum Breakover Current ( $I_{BO}$ ) | Minimum Holding Current ( $I_H$ ) | * Typical Capacitance @ 1MHz 2V Bias |
|-------------------|----------------|-------------------------------------|---|---------------------------------------|---|--|-----------------------------------|--------------------------------------|
|                   |                | V                                   | V   | V                                     | $\mu A$                                   | mA                                     | mA                                | pF                                   |
| CR0300 SA, SB, SC | 030 A, B, or C | 25                                  | 40  | 5                                     | 5   | 800.0                                  | 150.0                             | 200.0                                |
| CR0640 SA, SB, SC | 064 A, B, or C | 58                                  | 77  | 5                                     | 5   | 800.0                                  | 150.0                             | 120.0                                |
| CR0720 SA, SB, SC | 072 A, B, or C | 65                                  | 88  | 5                                     | 5   | 800.0                                  | 150.0                             | 90.0                                 |
| CR0800 SA, SB, SC | 080 A, B, or C | 75                                  | 98  | 5                                     | 5   | 800.0                                  | 150.0                             | 90.0                                 |
| CR1100 SA, SB, SC | 110 A, B, or C | 90                                  | 130   | 5                                     | 5   | 800.0                                  | 150.0                             | 90.0                                 |
| CR1300 SA, SB, SC | 130 A, B, or C | 120                                 | 160   | 5                                     | 5   | 800.0                                  | 150.0                             | 60.0                                 |
| CR1500 SA, SB, SC | 150 A, B, or C | 140                                 | 180   | 5                                     | 5   | 800.0                                  | 150.0                             | 60.0                                 |
| CR1800 SA, SB, SC | 180 A, B, or C | 160                                 | 220   | 5                                     | 5   | 800.0                                  | 150.0                             | 60.0                                 |
| CR2300 SA, SB, SC | 230 A, B, or C | 190                                 | 260   | 5                                     | 5   | 800.0                                  | 150.0                             | 45.0                                 |
| CR2600 SA, SB, SC | 260 A, B, or C | 220                                 | 300   | 5                                     | 5   | 800.0                                  | 150.0                             | 45.0                                 |
| CR3100 SA, SB, SC | 310 A, B, or C | 275                                 | 350   | 5                                     | 5   | 800.0                                  | 150.0                             | 45.0                                 |
| CR3500 SA, SB, SC | 350 A, B, or C | 320                                 | 400   | 5                                     | 5   | 800.0                                  | 150.0                             | 45.0                                 |
| CR4000 SA, SB, SC | 400 A, B or C  | 375                                 | 450   | 5                                     | 5   | 800.0                                  | 150.0                             | 45.0                                 |

\*Note: The typical capacitance values listed in this chart are for SA and SB. SC capacitance is approximately double that of SA and SB.

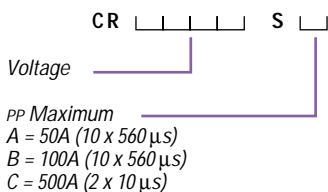

| Peak Pulse | SA  | SB  | SC  |
|------------|-----|-----|-----|
| 2/10µs     | -   | -   | 500 |
| 8/20µs     | 150 | 250 | 400 |
| 10/160µs   | 100 | 150 | 200 |
| 10/560µs   | 50  | 100 | -   |
| 10/1000µs  | -   | -   | 100 |

Thyristors (SiBOD™ Breakover Devices)

SiBOD Series  
TO-220



Electrical Characteristics (2 chip)

| Part Number |            | Reverse Stand-off Voltage (V <sub>R</sub> ) | Maximum Breakover Voltage (V <sub>BO</sub> ) @ I <sub>BO</sub> | Reverse Stand-off Voltage (V <sub>R</sub> ) | Maximum Breakover Voltage (V <sub>BO</sub> ) @ I <sub>BO</sub> | Typical Voltage Turnon (V <sub>T</sub> ) @ 1A | Maximum Reverse Leakage (I <sub>R</sub> ) @ V <sub>R</sub> | Maximum Breakover Current (I <sub>BO</sub> ) | Minimum Holding Current (I <sub>H</sub> ) | * Typical Cap. @1MHz 2V Bias |
|-------------|------------|---|--|---|--|---|--|--|---|------------------------------|
|             |            | pins 1-2 & 3-2                              |  | pins 1-3                                    |  |   |  |  |   |                              |
|             |            | V   | V  | V   | V  | V   | μA   | mA   | mA  | pF                           |
| CR0602      | AA, AB, AC | 25.0  | 40.0   | 50.0  | 80.0   | 5.0   | 1.0  | 800.0  | 150.0                                     | 200.0                        |
| CR1402      | AA, AB, AC | 58.0  | 77.0   | 116.0                                       | 154.0  | 5.0   | 1.0  | 800.0  | 150.0                                     | 120.0                        |
| CR1602      | AA, AB, AC | 65.0  | 95.0   | 130.0                                       | 190.0  | 5.0   | 1.0  | 800.0  | 150.0                                     | 90.0                         |
| CR2202      | AA, AB, AC | 90.0  | 130.0  | 180.0                                       | 260.0  | 5.0   | 1.0  | 800.0  | 150.0                                     | 90.0                         |
| CR2702      | AA, AB, AC | 120.0                                       | 160.0  | 240.0                                       | 320.0  | 5.0   | 1.0  | 800.0  | 150.0                                     | 60.0                         |
| CR3002      | AA, AB, AC | 140.0                                       | 180.0  | 280.0                                       | 360.0  | 5.0   | 1.0  | 800.0  | 150.0                                     | 60.0                         |
| CR3602      | AA, AB, AC | 160.0                                       | 220.0  | 320.0                                       | 440.0  | 5.0   | 1.0  | 800.0  | 150.0                                     | 60.0                         |
| CR4202      | AA, AB, AC | 190.0                                       | 250.0  | 380.0                                       | 500.0  | 5.0   | 1.0  | 800.0  | 150.0                                     | 45.0                         |
| CR4802      | AA, AB, AC | 220.0                                       | 300.0  | 440.0                                       | 600.0  | 5.0   | 1.0  | 800.0  | 150.0                                     | 45.0                         |
| CR6002      | AA, AB, AC | 275.0                                       | 350.0  | 550.0                                       | 700.0  | 5.0   | 1.0  | 800.0  | 150.0                                     | 45.0                         |

\*Note: The typical capacitance values listed in this chart are for AA and AB. AC capacitance is approximately double that of AA and AB.

Electrical Characteristics (3 chip)

| Part Number |            | Reverse Stand-off Voltage (V <sub>R</sub> ) | Maximum Breakover Voltage (V <sub>BO</sub> ) @ I <sub>BO</sub> | Reverse Stand-off Voltage (V <sub>R</sub> ) | Maximum Breakover Voltage (V <sub>BO</sub> ) @ I <sub>BO</sub> | Typical Voltage Turnon (V <sub>T</sub> ) @ 1A | Maximum Reverse Leakage (I <sub>R</sub> ) @ V <sub>R</sub> | Maximum Breakover Current (I <sub>BO</sub> ) | Minimum Holding Current (I <sub>H</sub> ) | * Typical Cap. @1MHz 2V Bias |
|-------------|------------|---|--|---|--|---|--|--|---|------------------------------|
|             |            | pins 1-2 & 3-2                              |  | pins 1-3                                    |  |   |  |  |   |                              |
|             |            | V   | V  | V   | V  | V   | μA   | mA   | mA  | pF                           |
| CR1553      | AA, AB, AC | 130.0                                       | 180.0  | 130.0                                       | 180.0  | 10.0  | 5.0  | 800.0  | 150.0                                     | 60.0                         |
| CR1803      | AA, AB, AC | 150.0                                       | 210.0  | 150.0                                       | 210.0  | 10.0  | 5.0  | 800.0  | 150.0                                     | 60.0                         |
| CR2103      | AA, AB, AC | 170.0                                       | 250.0  | 170.0                                       | 250.0  | 10.0  | 5.0  | 800.0  | 150.0                                     | 60.0                         |
| CR2353      | AA, AB, AC | 200.0                                       | 270.0  | 200.0                                       | 270.0  | 10.0  | 5.0  | 800.0  | 150.0                                     | 60.0                         |
| CR2703      | AA, AB, AC | 230.0                                       | 300.0  | 230.0                                       | 300.0  | 10.0  | 5.0  | 800.0  | 150.0                                     | 45.0                         |
| CR3203      | AA, AB, AC | 270.0                                       | 350.0  | 270.0                                       | 350.0  | 10.0  | 5.0  | 800.0  | 150.0                                     | 45.0                         |
| CR3403      | AA, AB, AC | 300.0                                       | 400.0  | 300.0                                       | 400.0  | 10.0  | 5.0  | 800.0  | 150.0                                     | 45.0                         |

\*Note: The typical capacitance values listed in this chart are for AA and AB. AC capacitance is approximately double that of AA and AB.

| Peak Pulse | AA  | AB  | AC  |
|------------|-----|-----|-----|
| 2/10μs     | -   | -   | 500 |
| 8/20μs     | 150 | 250 | 400 |
| 10/160μs   | 100 | 150 | 200 |
| 10/560μs   | 50  | 100 | -   |
| 10/1000μs  | -   | -   | 100 |

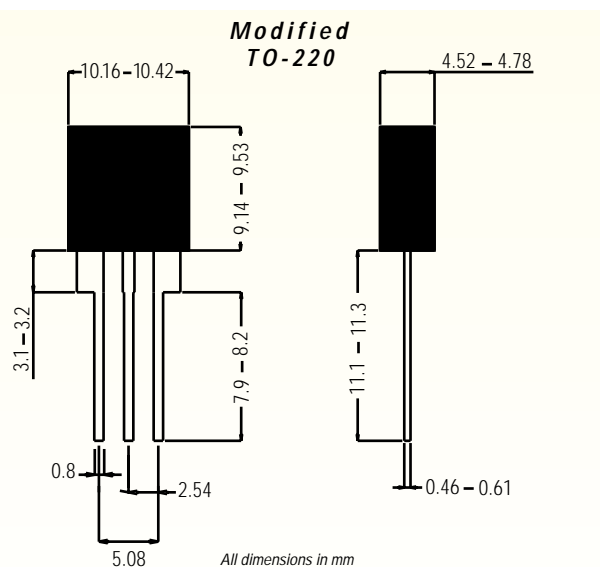
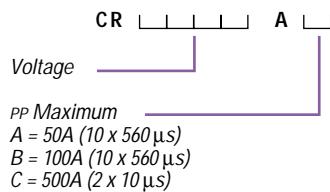



Thyristors (SiBOD™ Breakover Devices)

SiBOD Series  
T10A, T10B, T10C

T10A

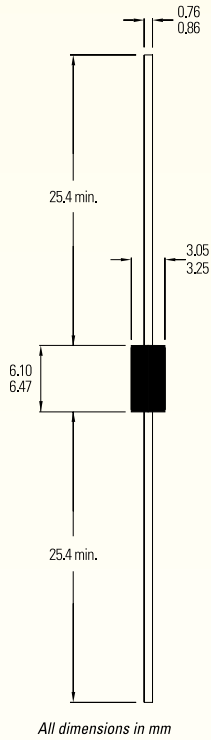

T10B

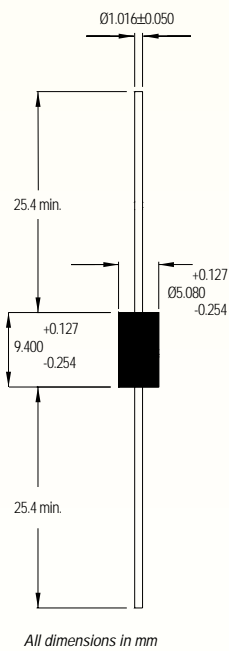

Electrical Characteristics

| DEVICE TYPE     | V <sub>RM</sub> (V) | I <sub>RM</sub> @ V <sub>RM</sub> (μA) | V <sub>BR</sub> MIN. @ 1 mA (V) | V <sub>BO</sub> MAX. (V) | V <sub>T</sub> TYP @ 1A (V) | I <sub>BO</sub> TYP (mA) | I <sub>H</sub> MIN. (mA) |
|-----------------|---------------------|--|---------------------------------|--------------------------|-----------------------------|--------------------------|--------------------------|
| T10 A, B, C 080 | 70                  | 1                                      | 80                              | 120                      | 2                           | 50                       | B or E                   |
| T10 A, B, C 110 | 100                 | 1                                      | 110                             | 135                      | 2                           | 50                       | B or E                   |
| T10 A, B, C 140 | 120                 | 1                                      | 140                             | 170                      | 2                           | 50                       | B or E                   |
| T10 A, B, C 180 | 170                 | 1                                      | 180                             | 210                      | 4                           | 50                       | B or E                   |
| T10 A, B, C 220 | 200                 | 1                                      | 215                             | 265                      | 4                           | 50                       | B or E                   |
| T10 A, B, C 270 | 240                 | 1                                      | 270                             | 360                      | 4                           | 50                       | B or E                   |

T10C

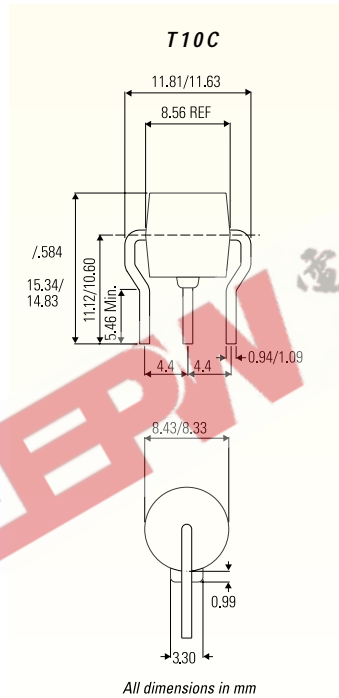

MINIMUM HOLDING CURRENTS I<sub>H</sub> MIN.

| Suffix | I <sub>H</sub> |
|--------|----------------|
| B      | 120            |
| E      | 180            |

FEATURES

- High current diverting capability, 150 A, 8 X 20 μs)
- Low capacitance, less than 100 pF

| Peak Pulse   | T10A | T10B | T10C |
|--------------|------|------|------|
| 8/20μs       | 150  | 250  | 250  |
| 10/700 1-5kv | 37.5 | 125  | 125  |
| 10/1000μs    | 50   | 100  | 100  |

T10

Package  
A = DO15  
B = DO-201  
C = GDT outline

Voltage

Holding current  
B = 120 I<sub>H</sub> min.  
E = 180 I<sub>H</sub> min.



## Thyristors (SiBOD™ Breakover Devices)



### SiBOD™ Series

#### Specify Crydom

... for these industry-leading components and products:

- **Solid State Relays**
  - Printed Circuit Board Mount
  - Panel Mount
  - DIN Rail Mount
- **Power Cubes**
- **I/O Modules**
- **Transient Voltage Suppression Components**
  - TVS Diodes
  - Thyristor Suppression Devices
  - Gas Discharge Tubes (GDT)
  - Zeners/Studs
  - Hybrid Arrester Devices

#### Ordering Information

For recommended applications and more information contact:

Sales: 1-877-502-5500

Technical support: 1-877-702-7700

Corporate Headquarters: 1-858-715-7200

Fax: 1-858-715-7280

E-mail: [sales@crydom.com](mailto:sales@crydom.com)

Website: [www.crydom.com](http://www.crydom.com)

FASTFAX Product Info: 1-888-267-9191

#### About Crydom

Over the years Crydom has become the supplier of choice for advanced, high-quality products like those featured here. It's the result of our teams of design and production engineers – material, production control, and quality assurance experts, and more – working seamlessly together to create, produce, and deliver superior components and products that satisfy the most demanding environmental and performance requirements. We focus on timely delivery and competitive pricing aimed at meeting your needs and helping you succeed in today's fast-paced, fast-changing global markets.



#### Crydom

9525 Chesapeake Drive  
San Diego, CA 92123 USA



© 1999 Crydom  
Specifications subject to change without notice.