

Common Mode Filters(SMD) For xDSL

Conformity to RoHS Directive

ZCYS Series

FEATURES

- ZCYS series provide highly effective noise rejection characteristics without distorting the transmission signal. Therefore this product is most suitable for an application of a xDSL interface circuit.
- The products contain no lead and also support lead-free soldering.

APPLICATIONS

xDSL, modem, Pots-splitters for DSLAM

PRODUCT IDENTIFICATION

ZCYS	8684	-902	-2P	-TL
(1)	(2)	(3)	(4)	(5)

- (1)Series name
 - (2)Case size
 - (3)Inductance code
 - (4)Number of lines
 - (5)Packaging style
- TL: Taping(ø330mm reel)

TEMPERATURE RANGE

Operating	-25 to +85°C
-----------	--------------

PACKAGING STYLE AND QUANTITIES

Type	Quantity
ZCYS8684	1000pieces/reel
ZCYS9058	1500pieces/reel
ZCYS1512	500pieces/reel

SHAPES AND DIMENSIONS/RECOMMENDED PC BOARD PATTERNS

ZCYS8684 TYPE

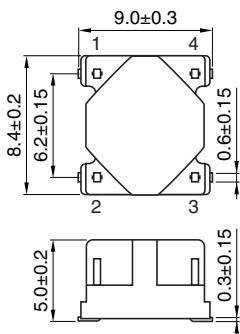

Weight: 0.57g
Dimensions in mm

ZCYS9058 TYPE

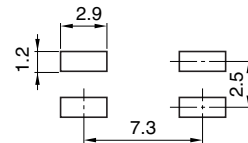
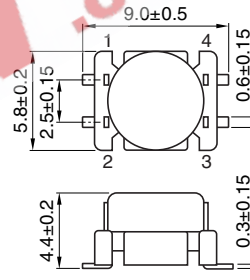

Weight: 0.32g
Dimensions in mm

ZCYS1512 TYPE

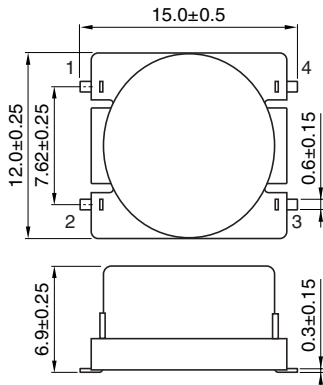

Weight: 1.53g
Dimensions in mm

CIRCUIT DIAGRAM

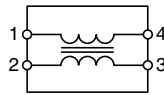

• Conformity to RoHS Directive: This means that, in conformity with EU Directive 2002/95/EC, lead, cadmium, mercury, hexavalent chromium, and specific bromine-based flame retardants, PBB and PBDE, have not been used, except for exempted applications.

• All specifications are subject to change without notice.

ELECTRICAL CHARACTERISTICS

Part No.	Common mode inductance (mH)[100kHz]	DC resistance (Ω)max.	Rated current (A)max.	Rated voltage (V)max.	Insulation resistance (M Ω)min.
ZCYS8684-472-2P	4.7 \pm 30%	1.0	0.4	80	100
ZCYS8684-902-2P	9.0 \pm 30%	1.2	0.3	80	100
ZCYS9058-471-2P	0.47 \pm 30%	0.5	0.3	80	100
ZCYS9058-222-2P	2.2 \pm 30%	0.7	0.3	80	100
ZCYS9058-472-2P	4.7 \pm 30%	1.0	0.3	80	100
ZCYS1512-203-2P	20 \pm 30%	2.0	0.2	80	100

TYPICAL ELECTRICAL CHARACTERISTICS

INSERTION LOSS (COMMON MODE) vs. FREQUENCY CHARACTERISTICS

ZCYS8684-472-2P

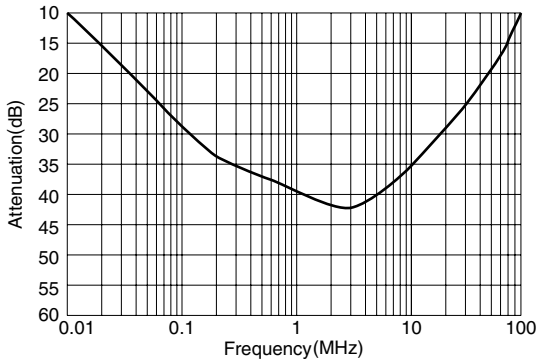

ZCYS8684-902-2P

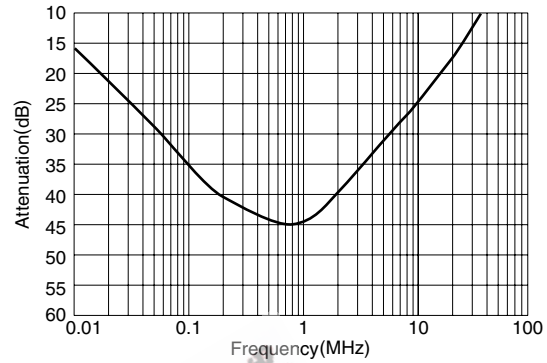

ZCYS9058-471-2P

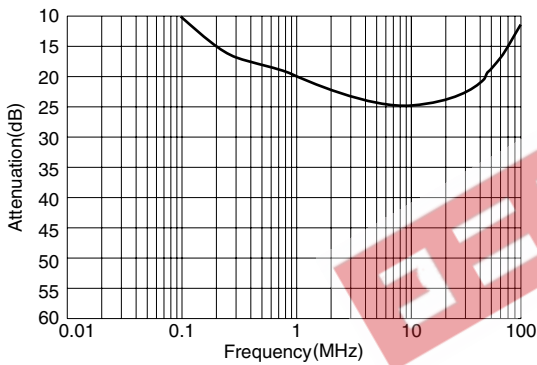

ZCYS9058-222-2P

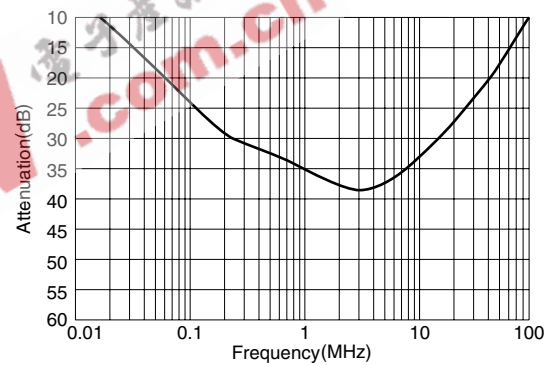

ZCYS9058-472-2P

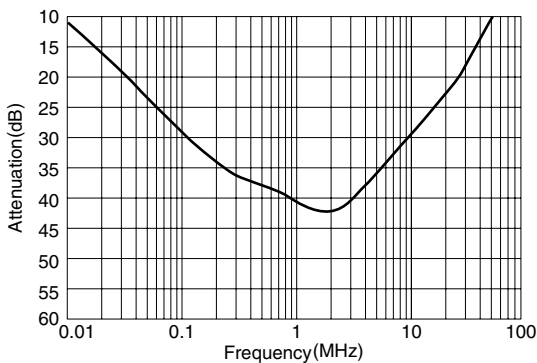

ZCYS1512-203-2P

