

**Z8400/Z84C00 NMOS/CMOS  
Z80<sup>®</sup> CPU  
Central Processing Unit**

**FEATURES**

- The extensive instruction set contains 158 instructions, including the 8080A instruction set as a subset.
- The Z80 microprocessors and associated family of peripherals can be linked by a vectored interrupt system. This system can be daisy-chained to allow implementation of a priority interrupt scheme.
- NMOS version for low cost high performance solutions, CMOS version for high performance low power designs.
- Duplicate set of both general-purpose and flag registers.
- NMOS Z840004 - 4 MHz, Z840006 - 6.17 MHz, Z840008 - 8 MHz.
- Two sixteen-bit index registers.
- CMOS Z84C0006 - DC to 6.17 MHz, Z84C008 - DC to 8 MHz, Z84C0010 - DC to 10 MHz, Z84C0020 - DC - 20 MHz.
- Three modes of maskable interrupts:  
Mode 0—8080A similar;  
Mode 1—Non-Z80 environment, location 38H;  
Mode 2—Z80 family peripherals, vectored interrupts.
- 6 MHz version can be operated at 6.144 MHz clock.
- On-chip dynamic memory refresh counter.

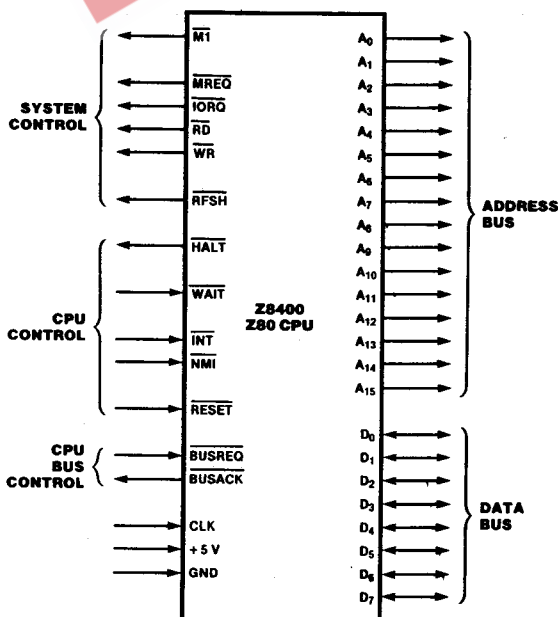

Figure 1. Pin Functions

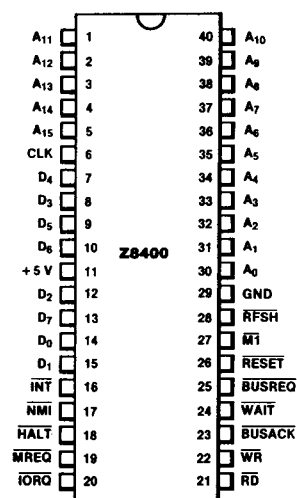
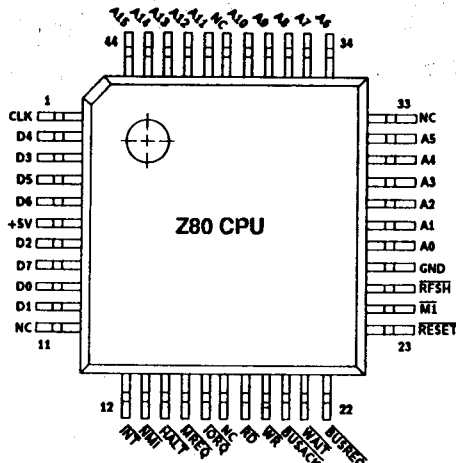

Figure 2. 40-pin Dual-In-Line (DIP), Pin Assignments



44 pin Quad Flat Pack (QFP), Pin Assignments  
(Only available for 84C00)

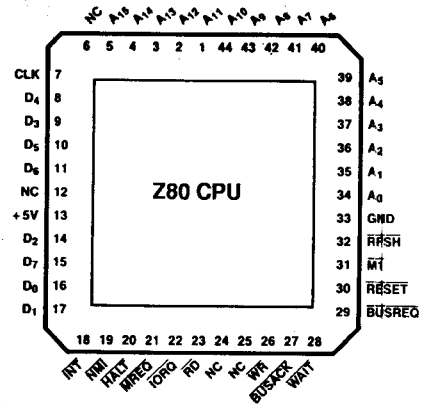

Figure 2b. 44-Pin Chip Carrier Pin Assignments

### GENERAL DESCRIPTION

The CPUs are fourth-generation enhanced microprocessors with exceptional computational power. They offer higher system throughput and more efficient memory utilization than comparable second- and third-generation microprocessors. The internal registers contain 208 bits of read/write memory that are accessible to the programmer. These registers include two sets of six general-purpose registers which may be used individually as either 8-bit registers or as 16-bit register pairs. In addition, there are two sets of accumulator and flag registers. A group of "Exchange" instructions makes either set of main or alternate registers accessible to the programmer. The alternate set allows operation in foreground-background mode or it may be reserved for very fast interrupt response.

The CPU also contains a Stack Pointer, Program Counter, two index registers, a Refresh register (counter), and an Interrupt register. The CPU is easy to incorporate into a system since it requires only a single +5V power source. All output signals are fully decoded and timed to control standard memory or peripheral circuits; the CPU is supported by an extensive family of peripheral controllers. The internal block diagram (Figure 3) shows the primary functions of the processors. Subsequent text provides more detail on the I/O controller family, registers, instruction set, interrupts and daisy chaining, and CPU timing.

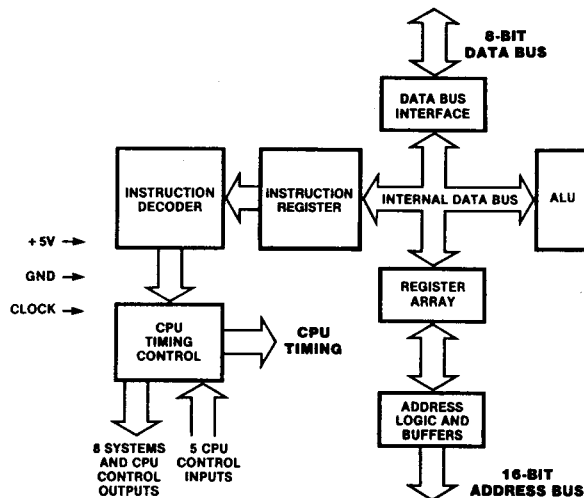

Figure 3. Z80C CPU Block Diagram

Table 1. Z80C CPU Registers

| Register   | Size (Bits)        | Remarks    |  |
|--|--------------------|------------|--|
| A, A'  | Accumulator        | 8          | Stores an operand or the results of an operation.  |
| F, F'  | Flags              | 8          | See Instruction Set.   |
| B, B'  | General Purpose    | 8          | Can be used separately or as a 16-bit register with C.   |
| C, C'  | General Purpose    | 8          | Can be used separately or as a 16-bit register with B.   |
| D, D'  | General Purpose    | 8          | Can be used separately or as a 16-bit register with E.   |
| E, E'  | General Purpose    | 8          | Can be used separately or as a 16-bit register with D.   |
| H, H'  | General Purpose    | 8          | Can be used separately or as a 16-bit register with L.   |
| L, L'  | General Purpose    | 8          | Can be used separately or as a 16-bit register with H.   |
| Note: The (B,C), (D,E), and (H,L) sets are combined as follows:<br>B — High byte    C — Low byte<br>D — High byte    E — Low byte<br>H — High byte    L — Low byte |                    |            |  |
| I  | Interrupt Register | 8          | Stores upper eight bits of memory address for vectored interrupt processing.   |
| R  | Refresh Register   | 8          | Provides user-transparent dynamic memory refresh. Automatically incremented and placed on the address bus during each instruction fetch cycle. |
| IX   | Index Register     | 16         | Used for indexed addressing.   |
| IY   | Index Register     | 16         | Used for indexed addressing.   |
| SP   | Stack Pointer      | 16         | Holds address of the top of the stack. See Push or Pop in instruction set.   |
| PC   | Program Counter    | 16         | Holds address of next instruction.   |
| IFF <sub>1</sub> -IFF <sub>2</sub>   | Interrupt Enable   | Flip-Flops | Set or reset to indicate interrupt status (see Figure 4).  |
| IMFa-IMFb  | Interrupt Mode     | Flip-Flops | Reflect Interrupt mode (see Figure 4).   |

failure has been detected. After recognition of the  $\overline{\text{NMI}}$  signal (providing  $\overline{\text{BUSREQ}}$  is not active), the CPU jumps to restart location 0066H. Normally, software starting at this address contains the interrupt service routine.

**Maskable Interrupt ( $\overline{\text{INT}}$ ).** Regardless of the interrupt mode set by the user, the CPU response to a maskable interrupt input follows a common timing cycle. After the interrupt has been detected by the CPU (provided that interrupts are enabled and  $\overline{\text{BUSREQ}}$  is not active) a special interrupt processing cycle begins. This is a special fetch ( $\overline{\text{M1}}$ ) cycle in which  $\overline{\text{IORQ}}$  becomes active rather than  $\overline{\text{MREQ}}$ , as in a normal  $\overline{\text{M1}}$  cycle. In addition, this special  $\overline{\text{M1}}$  cycle is automatically extended by two  $\overline{\text{WAIT}}$  states, to allow for the time required to acknowledge the interrupt request.

**Mode 0 Interrupt Operation.** This mode is similar to the 8080 microprocessor interrupt service procedures. The interrupting device places an instruction on the data bus. This is normally a Restart instruction, which will initiate a call

to the selected one of eight restart locations in page zero of memory. Unlike the 8080, the Z80 CPU responds to the Call instruction with only one interrupt acknowledge cycle followed by two memory read cycles.

**Mode 1 Interrupt Operation.** Mode 1 operation is very similar to that for the  $\overline{\text{NMI}}$ . The principal difference is that the Mode 1 interrupt has only one restart location, 0038H.

**Mode 2 Interrupt Operation.** This interrupt mode has been designed to most effectively utilize the capabilities of the Z80 microprocessor and its associated peripheral family. The interrupting peripheral device selects the starting address of the interrupt service routine. It does this by placing an 8-bit vector on the data bus during the interrupt acknowledge cycle. The CPU forms a pointer using this byte as the lower 8 bits and the contents of the I register as the upper 8 bits. This points to an entry in a table of addresses for interrupt service routines. The CPU then jumps to the routine at that

address. This flexibility in selecting the interrupt service routine address allows the peripheral device to use several different types of service routines. These routines may be located at any available location in memory. Since the interrupting device supplies the low-order byte of the 2-byte vector, bit 0 ( $A_0$ ) must be a zero.

**Interrupt Enable/Disable Operation.** Two flip-flops, IFF<sub>1</sub> and IFF<sub>2</sub>, referred to in the register description, are used to signal the CPU interrupt status. Operation of the two flip-flops is described in Table 2. For more details, refer to the *Z80 CPU Technical Manual* (03-0029-01) and *Z80 Assembly Language Programming Manual* (03-0002-01).

Table 2. State of Flip-Flops

| Action                       | IFF <sub>1</sub> | IFF <sub>2</sub> | Comments  |
|------------------------------|------------------|------------------|---|
| CPU Reset                    | 0                | 0                | Maskable interrupt<br>INT disabled  |
| DI instruction execution     | 0                | 0                | Maskable interrupt<br>INT disabled  |
| EI instruction execution     | 1                | 1                | Maskable interrupt<br>INT enabled   |
| LD A,I instruction execution | •                | •                | IFF <sub>2</sub> → Parity flag  |
| LD A,R instruction execution | •                | •                | IFF <sub>2</sub> → Parity flag  |
| Accept NMI                   | 0                | •                | Maskable interrupt<br>INT disabled  |
| RETN instruction execution   | IFF <sub>2</sub> | •                | IFF <sub>2</sub> → IFF <sub>1</sub> at<br>completion of an<br>NMI service<br>routine. |

## INSTRUCTION SET

The microprocessor has one of the most powerful and versatile instruction sets available in any 8-bit microprocessor. It includes such unique operations as a block move for fast, efficient data transfers within memory, or between memory and I/O. It also allows operations on any bit in any location in memory.

The following is a summary of the instruction set which shows the assembly language mnemonic, the operation, the flag status, and gives comments on each instruction. For an explanation of flag notations and symbols for mnemonic tables, see the Symbolic Notations section which follows these tables. The *Z80 CPU Technical Manual* (03-0029-01), the *Programmer's Reference Guide* (03-0012-03), and *Assembly Language Programming Manual* (03-0002-01) contain significantly more details for programming use.

The instructions are divided into the following categories:

- 8-bit loads
- 16-bit loads
- Exchanges, block transfers, and searches
- 8-bit arithmetic and logic operations
- General-purpose arithmetic and CPU control
- 16-bit arithmetic operations
- Rotates and shifts

- Bit set, reset, and test operations
- Jumps
- Calls, returns, and restarts
- Input and output operations

A variety of addressing modes are implemented to permit efficient and fast data transfer between various registers, memory locations, and input/output devices. These addressing modes include:

- Immediate
- Immediate extended
- Modified page zero
- Relative
- Extended
- Indexed
- Register
- Register indirect
- Implied
- Bit

### 8-BIT LOAD GROUP

| Mnemonic     | Symbolic Operation | Flags |   | Opcode |     |   |   | Hex | No. of Bytes | No. of M Cycles | No. of T States | Comments |    |   |   |               |       |
|--------------|--------------------|-------|---|--------|-----|---|---|-----|--------------|-----------------|-----------------|----------|----|---|---|---------------|-------|
|              |                    | S     | Z | H      | P/V | N | C |     |              |                 |                 |          |    |   |   |               |       |
| LD r, r'     | r ← r'             | •     | • | X      | •   | X | • | •   | •            | 01              | r               | r'       | 1  | 1 | 4 | r, r' Reg.    |       |
| LD r, n      | r ← n              | •     | • | X      | •   | X | • | •   | •            | 00              | r               | 110      | 2  | 2 | 7 | 000 B         |       |
|              |                    |       |   |        |     |   |   |     |              |                 |                 |          |    |   |   | ←n→           |       |
| LD r, (HL)   | r ← (HL)           | •     | • | X      | •   | X | • | •   | •            | 01              | r               | 110      | 1  | 2 | 7 | 010 D         |       |
| LD r, (IX+d) | r ← (IX+d)         | •     | • | X      | •   | X | • | •   | •            | 11              | 011             | 101      | DD | 3 | 5 | 19            | 011 E |
|              |                    |       |   |        |     |   |   |     |              |                 |                 |          |    |   |   | 100 H         |       |
|              |                    |       |   |        |     |   |   |     |              |                 |                 |          |    |   |   | 101 L         |       |
| LD r, (IY+d) | r ← (IY+d)         | •     | • | X      | •   | X | • | •   | •            | 11              | 111             | 101      | FD | 3 | 5 | 19            | 111 A |
|              |                    |       |   |        |     |   |   |     |              |                 |                 |          |    |   |   | 01 r 110      |       |
|              |                    |       |   |        |     |   |   |     |              |                 |                 |          |    |   |   | ←d→           |       |
| LD (HL), r   | (HL) ← r           | •     | • | X      | •   | X | • | •   | •            | 01              | 110             | r        | 1  | 2 | 7 |               |       |
| LD (IX+d), r | (IX+d) ← r         | •     | • | X      | •   | X | • | •   | •            | 11              | 011             | 101      | DD | 3 | 5 | 19            |       |
|              |                    |       |   |        |     |   |   |     |              |                 |                 |          |    |   |   | 01 110 r      |       |
|              |                    |       |   |        |     |   |   |     |              |                 |                 |          |    |   |   | ←d→           |       |
| LD (IY+d), r | (IY+d) ← r         | •     | • | X      | •   | X | • | •   | •            | 11              | 111             | 101      | FD | 3 | 5 | 19            |       |
|              |                    |       |   |        |     |   |   |     |              |                 |                 |          |    |   |   | 01 110 r      |       |
|              |                    |       |   |        |     |   |   |     |              |                 |                 |          |    |   |   | ←d→           |       |
| LD (HL), n   | (HL) ← n           | •     | • | X      | •   | X | • | •   | •            | 00              | 110             | 110      | 36 | 2 | 3 | 10            |       |
|              |                    |       |   |        |     |   |   |     |              |                 |                 |          |    |   |   | ←n→           |       |
| LD (IX+d), n | (IX+d) ← n         | •     | • | X      | •   | X | • | •   | •            | 11              | 011             | 101      | DD | 4 | 5 | 19            |       |
|              |                    |       |   |        |     |   |   |     |              |                 |                 |          |    |   |   | 00 110 110 36 |       |
|              |                    |       |   |        |     |   |   |     |              |                 |                 |          |    |   |   | ←d→           |       |
|              |                    |       |   |        |     |   |   |     |              |                 |                 |          |    |   |   | ←n→           |       |

### 8-BIT LOAD GROUP (Continued)

| Mnemonic     | Symbolic Operation | S | Z | Flags |     |   | Opcode |    |     |     | No. of Bytes | No. of M Cycles | No. of T States | Comments |     |  |
|--------------|--------------------|---|---|-------|-----|---|--------|----|-----|-----|--------------|-----------------|-----------------|----------|-----|--|
|              |                    |   |   | H     | P/V | N | C      | 76 | 543 | 210 |              |                 |                 |          | Hex |  |
| LD (IY+d), n | (IY+d) ← n         | • | • | X     | •   | X | •      | •  | •   | •   | 11 111 101   | FD              | 4               | 5        | 19  |  |
|              |                    |   |   |       |     |   |        |    |     |     | 00 110 110   | 36              |                 |          |     |  |
|              |                    |   |   |       |     |   |        |    |     |     | ← d →        |                 |                 |          |     |  |
|              |                    |   |   |       |     |   |        |    |     |     | ← n →        |                 |                 |          |     |  |
| LDA, (BC)    | A ← (BC)           | • | • | X     | •   | X | •      | •  | •   | •   | 00 001 010   | 0A              | 1               | 2        | 7   |  |
| LDA, (DE)    | A ← (DE)           | • | • | X     | •   | X | •      | •  | •   | •   | 00 011 010   | 1A              | 1               | 2        | 7   |  |
| LDA, (nn)    | A ← (nn)           | • | • | X     | •   | X | •      | •  | •   | •   | 00 111 010   | 3A              | 3               | 4        | 13  |  |
|              |                    |   |   |       |     |   |        |    |     |     | ← n →        |                 |                 |          |     |  |
|              |                    |   |   |       |     |   |        |    |     |     | ← n →        |                 |                 |          |     |  |
| LD (BC), A   | (BC) ← A           | • | • | X     | •   | X | •      | •  | •   | •   | 00 000 010   | 02              | 1               | 2        | 7   |  |
| LD (DE), A   | (DE) ← A           | • | • | X     | •   | X | •      | •  | •   | •   | 00 010 010   | 12              | 1               | 2        | 7   |  |
| LD (nn), A   | (nn) ← A           | • | • | X     | •   | X | •      | •  | •   | •   | 00 110 010   | 32              | 3               | 4        | 13  |  |
|              |                    |   |   |       |     |   |        |    |     |     | ← n →        |                 |                 |          |     |  |
|              |                    |   |   |       |     |   |        |    |     |     | ← n →        |                 |                 |          |     |  |
| LDA, I       | A ← I              | ‡ | ‡ | X     | 0   | X | IFF    | 0  | •   | •   | 11 101 101   | ED              | 2               | 2        | 9   |  |
|              |                    |   |   |       |     |   |        |    |     |     | 01 010 111   | 57              |                 |          |     |  |
| LDA, R       | A ← R              | ‡ | ‡ | X     | 0   | X | IFF    | 0  | •   | •   | 11 101 101   | ED              | 2               | 2        | 9   |  |
|              |                    |   |   |       |     |   |        |    |     |     | 01 011 111   | 5F              |                 |          |     |  |
| LDI, A       | I ← A              | • | • | X     | •   | X | •      | •  | •   | •   | 11 101 101   | ED              | 2               | 2        | 9   |  |
|              |                    |   |   |       |     |   |        |    |     |     | 01 000 111   | 47              |                 |          |     |  |
| LDR, A       | R ← A              | • | • | X     | •   | X | •      | •  | •   | •   | 11 101 101   | ED              | 2               | 2        | 9   |  |
|              |                    |   |   |       |     |   |        |    |     |     | 01 001 111   | 4F              |                 |          |     |  |

NOTE: IFF, the content of the interrupt enable flip-flop, (IFF<sub>2</sub>), is copied into the P/V flag.

### 16-BIT LOAD GROUP

| Mnemonic    | Symbolic Operation                                 | S | Z | Flags |     |   | Opcode |    |     |     | No. of Bytes | No. of M Cycles | No. of T States | Comments |     |         |
|-------------|--|---|---|-------|-----|---|--------|----|-----|-----|--------------|-----------------|-----------------|----------|-----|---------|
|             |  |   |   | H     | P/V | N | C      | 76 | 543 | 210 |              |                 |                 |          | Hex |         |
| LD dd, nn   | dd ← nn  | • | • | X     | •   | X | •      | •  | •   | •   | 00 dd0 001   |                 | 3               | 3        | 10  | dd Pair |
|             |  |   |   |       |     |   |        |    |     |     | ← n →        |                 |                 |          |     | 00 BC   |
|             |  |   |   |       |     |   |        |    |     |     | ← n →        |                 |                 |          |     | 01 DE   |
| LD IX, nn   | IX ← nn  | • | • | X     | •   | X | •      | •  | •   | •   | 11 011 101   | DD              | 4               | 4        | 14  | 10 HL   |
|             |  |   |   |       |     |   |        |    |     |     | 00 100 001   | 21              |                 |          |     | 11 SP   |
|             |  |   |   |       |     |   |        |    |     |     | ← n →        |                 |                 |          |     |         |
|             |  |   |   |       |     |   |        |    |     |     | ← n →        |                 |                 |          |     |         |
| LD IY, nn   | IY ← nn  | • | • | X     | •   | X | •      | •  | •   | •   | 11 111 101   | FD              | 4               | 4        | 14  |         |
|             |  |   |   |       |     |   |        |    |     |     | 00 100 001   | 21              |                 |          |     |         |
|             |  |   |   |       |     |   |        |    |     |     | ← n →        |                 |                 |          |     |         |
|             |  |   |   |       |     |   |        |    |     |     | ← n →        |                 |                 |          |     |         |
| LD HL, (nn) | H ← (nn+1)<br>L ← (nn)                             | • | • | X     | •   | X | •      | •  | •   | •   | 00 101 010   | 2A              | 3               | 5        | 16  |         |
|             |  |   |   |       |     |   |        |    |     |     | ← n →        |                 |                 |          |     |         |
|             |  |   |   |       |     |   |        |    |     |     | ← n →        |                 |                 |          |     |         |
| LD dd, (nn) | dd <sub>H</sub> ← (nn+1)<br>dd <sub>L</sub> ← (nn) | • | • | X     | •   | X | •      | •  | •   | •   | 11 101 101   | ED              | 4               | 6        | 20  |         |
|             |  |   |   |       |     |   |        |    |     |     | 01 dd1 011   |                 |                 |          |     |         |
|             |  |   |   |       |     |   |        |    |     |     | ← n →        |                 |                 |          |     |         |
|             |  |   |   |       |     |   |        |    |     |     | ← n →        |                 |                 |          |     |         |

NOTE: (PAIR)<sub>H</sub>, (PAIR)<sub>L</sub> refer to high order and low order eight bits of the register pair respectively. e.g., BC<sub>L</sub> = C, AF<sub>H</sub> = A.

### 16-BIT LOAD GROUP (Continued)

| Mnemonic    | Symbolic Operation       | S | Z | Flags |     |   |   | Opcode |     |     |     | No. of Bytes | No. of M Cycles | No. of T States | Comments |   |    |    |      |
|-------------|--------------------------|---|---|-------|-----|---|---|--------|-----|-----|-----|--------------|-----------------|-----------------|----------|---|----|----|------|
|             |                          |   |   | H     | P/V | N | C | 76     | 543 | 210 | Hex |              |                 |                 |          |   |    |    |      |
| LD IX, (nn) | $IX_H \leftarrow (nn+1)$ | • | • | X     | •   | X | • | •      | •   | •   | 11  | 011          | 101             | DD              | 4        | 6 | 20 |    |      |
|             | $IX_L \leftarrow (nn)$   |   |   |       |     |   |   |        |     |     | 00  | 101          | 010             | 2A              |          |   |    |    |      |
|             |                          |   |   |       |     |   |   |        |     |     |     |              |                 |                 |          |   |    |    |      |
|             |                          |   |   |       |     |   |   |        |     |     |     |              |                 |                 |          |   |    |    |      |
| LD IY, (nn) | $IY_H \leftarrow (nn+1)$ | • | • | X     | •   | X | • | •      | •   | •   | 11  | 111          | 101             | FD              | 4        | 6 | 20 |    |      |
|             | $IY_L \leftarrow (nn)$   |   |   |       |     |   |   |        |     |     | 00  | 101          | 010             | 2A              |          |   |    |    |      |
|             |                          |   |   |       |     |   |   |        |     |     |     |              |                 |                 |          |   |    |    |      |
|             |                          |   |   |       |     |   |   |        |     |     |     |              |                 |                 |          |   |    |    |      |
| LD (nn), HL | $(nn+1) \leftarrow H$    | • | • | X     | •   | X | • | •      | •   | •   | 00  | 100          | 010             | 22              | 3        | 5 | 16 |    |      |
|             | $(nn) \leftarrow L$      |   |   |       |     |   |   |        |     |     |     |              |                 |                 |          |   |    |    |      |
|             |                          |   |   |       |     |   |   |        |     |     |     |              |                 |                 |          |   |    |    |      |
|             |                          |   |   |       |     |   |   |        |     |     |     |              |                 |                 |          |   |    |    |      |
| LD (nn), dd | $(nn+1) \leftarrow dd_H$ | • | • | X     | •   | X | • | •      | •   | •   | 11  | 101          | 101             | ED              | 4        | 6 | 20 |    |      |
|             | $(nn) \leftarrow dd_L$   |   |   |       |     |   |   |        |     |     | 01  | dd0          | 011             |                 |          |   |    |    |      |
|             |                          |   |   |       |     |   |   |        |     |     |     |              |                 |                 |          |   |    |    |      |
|             |                          |   |   |       |     |   |   |        |     |     |     |              |                 |                 |          |   |    |    |      |
| LD (nn), IX | $(nn+1) \leftarrow IX_H$ | • | • | X     | •   | X | • | •      | •   | •   | 11  | 011          | 101             | DD              | 4        | 6 | 20 |    |      |
|             | $(nn) \leftarrow IX_L$   |   |   |       |     |   |   |        |     |     | 00  | 100          | 010             | 22              |          |   |    |    |      |
|             |                          |   |   |       |     |   |   |        |     |     |     |              |                 |                 |          |   |    |    |      |
|             |                          |   |   |       |     |   |   |        |     |     |     |              |                 |                 |          |   |    |    |      |
| LD (nn), IY | $(nn+1) \leftarrow IY_H$ | • | • | X     | •   | X | • | •      | •   | •   | 11  | 111          | 101             | FD              | 4        | 6 | 20 |    |      |
|             | $(nn) \leftarrow IY_L$   |   |   |       |     |   |   |        |     |     | 00  | 100          | 010             | 22              |          |   |    |    |      |
|             |                          |   |   |       |     |   |   |        |     |     |     |              |                 |                 |          |   |    |    |      |
|             |                          |   |   |       |     |   |   |        |     |     |     |              |                 |                 |          |   |    |    |      |
| LD SP, HL   | $SP \leftarrow HL$       | • | • | X     | •   | X | • | •      | •   | •   | 11  | 111          | 001             | F9              | 1        | 1 | 6  |    |      |
| LD SP, IX   | $SP \leftarrow IX$       | • | • | X     | •   | X | • | •      | •   | •   | 11  | 011          | 101             | DD              | 2        | 2 | 10 |    |      |
|             |                          |   |   |       |     |   |   |        |     |     | 11  | 111          | 001             | F9              |          |   |    |    |      |
|             |                          |   |   |       |     |   |   |        |     |     |     |              |                 |                 |          |   |    |    |      |
| LD SP, IY   | $SP \leftarrow IY$       | • | • | X     | •   | X | • | •      | •   | •   | 11  | 111          | 101             | FD              | 2        | 2 | 10 |    |      |
|             |                          |   |   |       |     |   |   |        |     |     | 11  | 111          | 001             | F9              |          |   |    |    |      |
|             |                          |   |   |       |     |   |   |        |     |     |     |              |                 |                 |          |   |    |    |      |
| PUSH qq     | $(SP-2) \leftarrow qq_L$ | • | • | X     | •   | X | • | •      | •   | •   | 11  | qq0          | 101             |                 | 1        | 3 | 11 | qq | Pair |
|             | $(SP-1) \leftarrow qq_H$ |   |   |       |     |   |   |        |     |     |     |              |                 |                 |          |   |    | 00 | BC   |
|             | $SP \rightarrow SP - 2$  |   |   |       |     |   |   |        |     |     |     |              |                 |                 |          |   |    | 01 | DE   |
|             |                          |   |   |       |     |   |   |        |     |     |     |              |                 |                 |          |   |    |    |      |
| PUSH IX     | $(SP-2) \leftarrow IX_L$ | • | • | X     | •   | X | • | •      | •   | •   | 11  | 011          | 101             | DD              | 2        | 4 | 15 | 11 | AF   |
|             | $(SP-1) \leftarrow IX_H$ |   |   |       |     |   |   |        |     |     | 11  | 100          | 101             | E5              |          |   |    |    |      |
|             | $SP \rightarrow SP - 2$  |   |   |       |     |   |   |        |     |     |     |              |                 |                 |          |   |    |    |      |
|             |                          |   |   |       |     |   |   |        |     |     |     |              |                 |                 |          |   |    |    |      |
| PUSH IY     | $(SP-2) \leftarrow IY_L$ | • | • | X     | •   | X | • | •      | •   | •   | 11  | 111          | 101             | FD              | 2        | 4 | 15 |    |      |
|             | $(SP-1) \leftarrow IY_H$ |   |   |       |     |   |   |        |     |     | 11  | 100          | 101             | E5              |          |   |    |    |      |
|             | $SP \rightarrow SP - 2$  |   |   |       |     |   |   |        |     |     |     |              |                 |                 |          |   |    |    |      |
|             |                          |   |   |       |     |   |   |        |     |     |     |              |                 |                 |          |   |    |    |      |
| POP qq      | $qq_H \leftarrow (SP+1)$ | • | • | X     | •   | X | • | •      | •   | •   | 11  | qq0          | 001             |                 | 1        | 3 | 10 |    |      |
|             | $qq_L \leftarrow (SP)$   |   |   |       |     |   |   |        |     |     |     |              |                 |                 |          |   |    |    |      |
|             |                          |   |   |       |     |   |   |        |     |     |     |              |                 |                 |          |   |    |    |      |
|             |                          |   |   |       |     |   |   |        |     |     |     |              |                 |                 |          |   |    |    |      |
| POP IX      | $IX_H \leftarrow (SP+1)$ | • | • | X     | •   | X | • | •      | •   | •   | 11  | 011          | 101             | DD              | 2        | 4 | 14 |    |      |
|             | $IX_L \leftarrow (SP)$   |   |   |       |     |   |   |        |     |     | 11  | 100          | 001             | E1              |          |   |    |    |      |
|             | $SP \rightarrow SP + 2$  |   |   |       |     |   |   |        |     |     |     |              |                 |                 |          |   |    |    |      |
|             |                          |   |   |       |     |   |   |        |     |     |     |              |                 |                 |          |   |    |    |      |
| POP IY      | $IY_H \leftarrow (SP+1)$ | • | • | X     | •   | X | • | •      | •   | •   | 11  | 111          | 101             | FD              | 2        | 4 | 14 |    |      |
|             | $IY_L \leftarrow (SP)$   |   |   |       |     |   |   |        |     |     | 11  | 100          | 001             | E1              |          |   |    |    |      |
|             | $SP \rightarrow SP + 2$  |   |   |       |     |   |   |        |     |     |     |              |                 |                 |          |   |    |    |      |
|             |                          |   |   |       |     |   |   |        |     |     |     |              |                 |                 |          |   |    |    |      |

NOTE: (PAIR)<sub>H</sub>, (PAIR)<sub>L</sub> refer to high order and low order eight bits of the register pair respectively, e.g., BC<sub>L</sub> = C, AF<sub>H</sub> = A.

## EXCHANGE, BLOCK TRANSFER, BLOCK SEARCH GROUPS

| Mnemonic    | Symbolic Operation       | Flags |   | Opcode |     |   |   | No. of Bytes | No. of M Cycles | No. of T States | Comments |    |     |     |     |   |   |    |   |
|-------------|--------------------------|-------|---|--------|-----|---|---|--------------|-----------------|-----------------|----------|----|-----|-----|-----|---|---|----|---|
|             |                          | S     | Z | H      | P/V | N | C |              |                 |                 |          | 76 | 543 | 210 | Hex |   |   |    |   |
| EX DE, HL   | DE ↔ HL                  | •     | • | X      | •   | X | • | •            | •               | •               | •        | 11 | 101 | 011 | EB  | 1 | 1 | 4  |   |
| EX AF, AF'  | AF ↔ AF'                 | •     | • | X      | •   | X | • | •            | •               | •               | •        | 00 | 001 | 000 | 08  | 1 | 1 | 4  |   |
| EXX         | BC ↔ BC'                 | •     | • | X      | •   | X | • | •            | •               | •               | •        | 11 | 011 | 001 | D9  | 1 | 1 | 4  | Register bank and auxiliary register bank exchange                              |
|             | HL ↔ HL'                 |       |   |        |     |   |   |              |                 |                 |          |    |     |     |     |   |   |    |   |
| EX (SP), HL | H ↔ (SP+1)<br>L ↔ (SP)   | •     | • | X      | •   | X | • | •            | •               | •               | •        | 11 | 100 | 011 | E3  | 1 | 5 | 19 |   |
| EX (SP), IX | IX <sub>H</sub> ↔ (SP+1) | •     | • | X      | •   | X | • | •            | •               | •               | •        | 11 | 011 | 101 | DD  | 2 | 6 | 23 |   |
|             | IX <sub>L</sub> ↔ (SP)   |       |   |        |     |   |   |              |                 |                 |          | 11 | 100 | 011 | E3  |   |   |    |   |
| EX (SP), IY | IY <sub>H</sub> ↔ (SP+1) | •     | • | X      | •   | X | • | •            | •               | •               | •        | 11 | 111 | 101 | FD  | 2 | 6 | 23 |   |
|             | IY <sub>L</sub> ↔ (SP)   |       |   |        |     |   |   |              |                 |                 |          | 11 | 100 | 011 | E3  |   |   |    |   |
| LDI         | (DE) ← (HL)              | •     | • | X      | 0   | X | † | 0            | •               | •               | •        | 11 | 101 | 101 | ED  | 2 | 4 | 16 | Load (HL) into (DE), increment the pointers and decrement the byte counter (BC) |
|             | DE ← DE+1                |       |   |        |     |   |   |              |                 |                 |          | 10 | 100 | 000 | A0  |   |   |    |   |
|             | HL ← HL+1                |       |   |        |     |   |   |              |                 |                 |          |    |     |     |     |   |   |    |   |
|             | BC ← BC-1                |       |   |        |     |   |   |              |                 |                 |          |    |     |     |     |   |   |    |   |
| LDIR        | (DE) ← (HL)              | •     | • | X      | 0   | X | 0 | 0            | •               | •               | •        | 11 | 101 | 101 | ED  | 2 | 5 | 21 | If BC ≠ 0   |
|             | DE ← DE+1                |       |   |        |     |   |   |              |                 |                 |          | 10 | 110 | 000 | B0  | 2 | 4 | 16 | If BC = 0   |
|             | HL ← HL+1                |       |   |        |     |   |   |              |                 |                 |          |    |     |     |     |   |   |    |   |
|             | BC ← BC-1                |       |   |        |     |   |   |              |                 |                 |          |    |     |     |     |   |   |    |   |
|             | Repeat until BC = 0      |       |   |        |     |   |   |              |                 |                 |          |    |     |     |     |   |   |    |   |
| LDD         | (DE) ← (HL)              | •     | • | X      | 0   | X | † | 0            | •               | •               | •        | 11 | 101 | 101 | ED  | 2 | 4 | 16 |   |
|             | DE ← DE-1                |       |   |        |     |   |   |              |                 |                 |          | 10 | 101 | 000 | A8  |   |   |    |   |
|             | HL ← HL-1                |       |   |        |     |   |   |              |                 |                 |          |    |     |     |     |   |   |    |   |
|             | BC ← BC-1                |       |   |        |     |   |   |              |                 |                 |          |    |     |     |     |   |   |    |   |
| LDDR        | (DE) ← (HL)              | •     | • | X      | 0   | X | 0 | 0            | •               | •               | •        | 11 | 101 | 101 | ED  | 2 | 5 | 21 | If BC ≠ 0   |
|             | DE ← DE-1                |       |   |        |     |   |   |              |                 |                 |          | 10 | 111 | 000 | B8  | 2 | 4 | 16 | If BC = 0   |
|             | HL ← HL-1                |       |   |        |     |   |   |              |                 |                 |          |    |     |     |     |   |   |    |   |
|             | BC ← BC-1                |       |   |        |     |   |   |              |                 |                 |          |    |     |     |     |   |   |    |   |
|             | Repeat until BC = 0      |       |   |        |     |   |   |              |                 |                 |          |    |     |     |     |   |   |    |   |
| CPI         | A - (HL)                 | †     | † | X      | †   | X | † | 1            | •               | •               | •        | 11 | 101 | 101 | ED  | 2 | 4 | 16 |   |
|             | HL ← HL+1                |       |   |        |     |   |   |              |                 |                 |          | 10 | 100 | 001 | A1  |   |   |    |   |
|             | BC ← BC-1                |       |   |        |     |   |   |              |                 |                 |          |    |     |     |     |   |   |    |   |

NOTE: ① P/V flag is 0 if the result of BC-1 = 0, otherwise P/V = 1.  
 ② P/V flag is 0 only at completion of instruction.  
 ③ Z flag is 1 if A = HL, otherwise Z = 0.



**EXCHANGE, BLOCK TRANSFER, BLOCK SEARCH GROUPS (Continued)**

| Mnemonic | Symbolic Operation  | S Z |   | Flags |     |   |   | Opcode |     |     | Hex | No. of Bytes | No. of M Cycles | No. of T States | Comments               |
|----------|---|-----|---|-------|-----|---|---|--------|-----|-----|-----|--------------|-----------------|-----------------|------------------------|
|          |   | S   | Z | H     | P/V | N | C | 76     | 543 | 210 |     |              |                 |                 |                        |
| CPIR     | A ← (HL)  | ③   |   |       |     | ① |   | 11     | 101 | 101 | ED  | 2            | 5               | 21              | If BC ≠ 0 and A ≠ (HL) |
|          | HL ← HL + 1<br>BC ← BC - 1<br>Repeat until<br>A = (HL) or<br>BC = 0 |     |   |       |     |   |   | 10     | 110 | 001 | B1  | 2            | 4               | 16              | If BC = 0 or A = (HL)  |
| CPD      | A ← (HL)  | ③   |   |       |     | ① |   | 11     | 101 | 101 | ED  | 2            | 4               | 16              |                        |
|          | HL ← HL - 1<br>BC ← BC - 1  |     |   |       |     |   |   | 10     | 101 | 001 | A9  |              |                 |                 |                        |
| CPDR     | A ← (HL)  | ③   |   |       |     | ① |   | 11     | 101 | 101 | ED  | 2            | 5               | 21              | If BC ≠ 0 and A ≠ (HL) |
|          | HL ← HL - 1<br>BC ← BC - 1<br>Repeat until<br>A = (HL) or<br>BC = 0 |     |   |       |     |   |   | 10     | 111 | 001 | B9  | 2            | 4               | 16              | If BC = 0 or A = (HL)  |

NOTE: ① P/V flag is 0 if the result of BC - 1 = 0, otherwise PV = 1.  
 ② P/V flag is 0 only at completion of instruction.  
 ③ Z flag is 1 if A = (HL), otherwise Z = 0.

**8-BIT ARITHMETIC AND LOGICAL GROUP**

| Mnemonic      | Symbolic Operation | S Z |   | Flags |     |   |   | Opcode |     |     | Hex | No. of Bytes | No. of M Cycles | No. of T States | Comments |        |   |
|---------------|--------------------|-----|---|-------|-----|---|---|--------|-----|-----|-----|--------------|-----------------|-----------------|----------|--------|---|
|               |                    | S   | Z | H     | P/V | N | C | 76     | 543 | 210 |     |              |                 |                 |          |        |   |
| ADD A, r      | A ← A + r          | †   | † | X     | †   | X | V | 0      | †   | 10  | 000 | r            | 1               | 1               | 4        | r Reg. |   |
| ADD A, n      | A ← A + n          | †   | † | X     | †   | X | V | 0      | †   | 11  | 000 | 110          | 2               | 2               | 7        | 000 B  |   |
|               |                    |     |   |       |     |   |   |        |     |     |     |              |                 |                 |          | 001 C  |   |
|               |                    |     |   |       |     |   |   |        |     |     |     |              |                 |                 |          | 010 D  |   |
|               |                    |     |   |       |     |   |   |        |     |     |     |              |                 |                 |          | 011 E  |   |
| ADD A, (HL)   | A ← A + (HL)       | †   | † | X     | †   | X | V | 0      | †   | 10  | 000 | 110          | 1               | 2               | 7        | 011 E  |   |
| ADD A, (IX+d) | A ← A + (IX+d)     | †   | † | X     | †   | X | V | 0      | †   | 11  | 011 | 101          | DD              | 3               | 5        | 100 H  |   |
|               |                    |     |   |       |     |   |   |        |     |     |     |              |                 |                 |          | 101 L  |   |
|               |                    |     |   |       |     |   |   |        |     |     |     |              |                 |                 |          | 111 A  |   |
| ADD A, (IY+d) | A ← A + (IY+d)     | †   | † | X     | †   | X | V | 0      | †   | 11  | 111 | 101          | FD              | 3               | 5        | 19     |   |
|               |                    |     |   |       |     |   |   |        |     |     |     |              |                 |                 |          |        |   |
| ADC A, s      | A ← A + s + CY     | †   | † | X     | †   | X | V | 0      | †   |     | 001 |              |                 |                 |          |        | s is any of r, n, (HL), (IX+d), (IY+d) as shown for ADD instruction. The indicated bits replace the 000 in the ADD set above. |
| SUB s         | A ← A - s          | †   | † | X     | †   | X | V | 1      | †   |     | 010 |              |                 |                 |          |        |   |
| SBC A, s      | A ← A - s - CY     | †   | † | X     | †   | X | V | 1      | †   |     | 011 |              |                 |                 |          |        |   |
| AND s         | A ← A > s          | †   | † | X     | 1   | X | P | 0      | 0   |     | 100 |              |                 |                 |          |        |   |
| OR s          | A ← A > s          | †   | † | X     | 0   | X | P | 0      | 0   |     | 110 |              |                 |                 |          |        |   |
| XOR s         | A ← A ⊕ s          | †   | † | X     | 0   | X | P | 0      | 0   |     | 101 |              |                 |                 |          |        |   |
| CP s          | A ← s              | †   | † | X     | †   | X | V | 1      | †   |     | 111 |              |                 |                 |          |        |   |

## 8-BIT ARITHMETIC AND LOGICAL GROUP (Continued)

| Mnemonic   | Symbolic Operation   | Flags |   |   |     |   |   | Opcode |     |     |     | No. of Bytes | No. of M Cycles | No. of T States | Comments |    |  |
|------------|----------------------|-------|---|---|-----|---|---|--------|-----|-----|-----|--------------|-----------------|-----------------|----------|----|--|
|            |                      | S     | Z | H | P/V | N | C | 76     | 543 | 210 | Hex |              |                 |                 |          |    |  |
| INC r      | $r \leftarrow r+1$   | †     | † | X | †   | X | V | 0      | •   | 00  | r   | 100          | 1               | 1               | 4        |    |  |
| INC (HL)   | (HL) ←<br>(HL)+1     | †     | † | X | †   | X | V | 0      | •   | 00  | 110 | 100          | 1               | 3               | 11       |    |  |
| INC (IX+d) | (IX+d) ←<br>(IX+d)+1 | †     | † | X | †   | X | V | 0      | •   | 11  | 011 | 101          | DD              | 3               | 6        | 23 |  |
| INC (IY+d) | (IY+d) ←<br>(IY+d)+1 | †     | † | X | †   | X | V | 0      | •   | 11  | 111 | 101          | FD              | 3               | 6        | 23 |  |
| DEC m      | $m \leftarrow m-1$   | †     | † | X | †   | X | V | 1      | •   |     |     | 101          |                 |                 |          |    |  |

NOTE: m is any of r, (HL), (IX+d), (IY+d) as shown for INC. DEC same format and states as INC. Replace 100 with 101 in opcode.

## GENERAL-PURPOSE ARITHMETIC AND CPU CONTROL GROUPS

| Mnemonic | Symbolic Operation       | Flags |   |   |     |   |   | Opcode |     |     |     | No. of Bytes | No. of M Cycles | No. of T States | Comments |   |  |
|----------|--------------------------|-------|---|---|-----|---|---|--------|-----|-----|-----|--------------|-----------------|-----------------|----------|---|--|
|          |                          | S     | Z | H | P/V | N | C | 76     | 543 | 210 | Hex |              |                 |                 |          |   |  |
| DAA      | @                        | †     | † | X | †   | X | P | •      | †   | 00  | 100 | 111          | 27              | 1               | 1        | 4 | Decimal adjust accumulator                 |
| CPL      | $A \leftarrow \bar{A}$   | •     | • | X | 1   | X | • | 1      | •   | 00  | 101 | 111          | 2F              | 1               | 1        | 4 | Complement accumulator (one's complement). |
| NEG      | $A \leftarrow 0 - A$     | †     | † | X | †   | X | V | 1      | †   | 11  | 101 | 101          | ED              | 2               | 2        | 8 | Negate acc. (two's complement).            |
| CCF      | $CY \leftarrow \bar{CY}$ | •     | • | X | X   | X | • | 0      | †   | 00  | 111 | 111          | 3F              | 1               | 1        | 4 | Complement carry flag. Set carry flag.     |
| SCF      | $CY \leftarrow 1$        | •     | • | X | 0   | X | • | 0      | 1   | 00  | 110 | 111          | 37              | 1               | 1        | 4 | Set carry flag.                            |
| NOP      | No operation             | •     | • | X | •   | X | • | •      | •   | 00  | 000 | 000          | 00              | 1               | 1        | 4 |  |
| HALT     | CPU halted               | •     | • | X | •   | X | • | •      | •   | 01  | 110 | 110          | 76              | 1               | 1        | 4 |  |
| DI *     | $IFF \leftarrow 0$       | •     | • | X | •   | X | • | •      | •   | 11  | 110 | 011          | F3              | 1               | 1        | 4 |  |
| EI *     | $IFF \leftarrow 1$       | •     | • | X | •   | X | • | •      | •   | 11  | 111 | 011          | FB              | 1               | 1        | 4 |  |
| IM 0     | Set interrupt mode 0     | •     | • | X | •   | X | • | •      | •   | 11  | 101 | 101          | ED              | 2               | 2        | 8 |  |
| IM 1     | Set interrupt mode 1     | •     | • | X | •   | X | • | •      | •   | 11  | 101 | 101          | ED              | 2               | 2        | 8 |  |
| IM 2     | Set interrupt mode 2     | •     | • | X | •   | X | • | •      | •   | 11  | 101 | 101          | ED              | 2               | 2        | 8 |  |

NOTES: @ converts accumulator content into packed BCD following add or subtract with packed BCD operands.

IFF indicates the interrupt enable flip-flop.

CY indicates the carry flip-flop.

\* indicates interrupts are not sampled at the end of EI or DI.

## 16-BIT ARITHMETIC GROUP

| Mnemonic   | Symbolic Operation | S | Z | Flags |     |   |   | Opcode |     |     | Hex | No. of Bytes | No. of M Cycles | No. of T States | Comments |                  |   |
|------------|--------------------|---|---|-------|-----|---|---|--------|-----|-----|-----|--------------|-----------------|-----------------|----------|------------------|---|
|            |                    |   |   | H     | P/V | N | C | 76     | 543 | 210 |     |              |                 |                 |          |                  |   |
| ADD HL, ss | HL ← HL + ss       | • | • | X     | X   | X | • | 0      | †   | 00  | ss1 | 001          | 1               | 3               | 11       | ss Reg.<br>00 BC |   |
| ADC HL, ss | HL ←               |   |   |       |     |   |   |        |     |     |     |              |                 |                 |          |                  |   |
|            | HL + ss + CY       | † | † | X     | X   | X | V | 0      | †   | 11  | 101 | 101          | ED              | 2               | 4        | 15               | 01 DE<br>10 HL<br>11 SP                     |
| SBC HL, ss | HL ←               |   |   |       |     |   |   |        |     |     |     |              |                 |                 |          |                  |   |
|            | HL - ss - CY       | † | † | X     | X   | X | V | 1      | †   | 11  | 101 | 101          | ED              | 2               | 4        | 15               | 01 ss0 010                                  |
| ADD IX, pp | IX ← IX + pp       | • | • | X     | X   | X | • | 0      | †   | 11  | 011 | 101          | DD              | 2               | 4        | 15               | pp Reg.<br>00 BC<br>01 DE<br>10 IX<br>11 SP |
|            |                    |   |   |       |     |   |   |        |     |     |     |              |                 |                 |          |                  | 01 pp1 001                                  |
| ADD IY, rr | IY ← IY + rr       | • | • | X     | X   | X | • | 0      | †   | 11  | 111 | 101          | FD              | 2               | 4        | 15               | rr Reg.<br>00 BC                            |
|            |                    |   |   |       |     |   |   |        |     |     |     |              |                 |                 |          |                  | 00 rr1 001                                  |
| INC ss     | ss ← ss + 1        | • | • | X     | •   | X | • | •      | •   | 00  | ss0 | 011          |                 | 1               | 1        | 6                | 01 DE                                       |
| INC IX     | IX ← IX + 1        | • | • | X     | •   | X | • | •      | •   | 11  | 011 | 101          | DD              | 2               | 2        | 10               | 10 IY                                       |
|            |                    |   |   |       |     |   |   |        |     | 00  | 100 | 011          | 23              |                 |          |                  | 11 SP                                       |
| INC IY     | IY ← IY + 1        | • | • | X     | •   | X | • | •      | •   | 11  | 111 | 101          | FD              | 2               | 2        | 10               |   |
|            |                    |   |   |       |     |   |   |        |     | 00  | 100 | 011          | 23              |                 |          |                  |   |
| DEC ss     | ss ← ss - 1        | • | • | X     | •   | X | • | •      | •   | 00  | ss1 | 011          |                 | 1               | 1        | 6                |   |
| DEC IX     | IX ← IX - 1        | • | • | X     | •   | X | • | •      | •   | 11  | 011 | 101          | DD              | 2               | 2        | 10               |   |
|            |                    |   |   |       |     |   |   |        |     | 00  | 101 | 011          | 2B              |                 |          |                  |   |
| DEC IY     | IY ← IY - 1        | • | • | X     | •   | X | • | •      | •   | 11  | 111 | 101          | FD              | 2               | 2        | 10               |   |
|            |                    |   |   |       |     |   |   |        |     | 00  | 101 | 011          | 2B              |                 |          |                  |   |

## ROTATE AND SHIFT GROUP

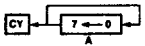
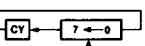
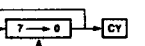
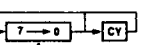
| Mnemonic | Symbolic Operation  | S | Z | Flags |     |   |   | Opcode |     |     | Hex | No. of Bytes | No. of M Cycles | No. of T States | Comments |   |                                    |
|----------|---|---|---|-------|-----|---|---|--------|-----|-----|-----|--------------|-----------------|-----------------|----------|---|------------------------------------|
|          |   |   |   | H     | P/V | N | C | 76     | 543 | 210 |     |              |                 |                 |          |   |                                    |
| RLCA     |  | • | • | X     | 0   | X | • | 0      | †   | 00  | 000 | 111          | 07              | 1               | 1        | 4 | Rotate left circular accumulator.  |
| RLA      |  | • | • | X     | 0   | X | • | 0      | †   | 00  | 010 | 111          | 17              | 1               | 1        | 4 | Rotate left accumulator.           |
| RRCA     |  | • | • | X     | 0   | X | • | 0      | †   | 00  | 001 | 111          | 0F              | 1               | 1        | 4 | Rotate right circular accumulator. |
| RRA      |  | • | • | X     | 0   | X | • | 0      | †   | 00  | 011 | 111          | 1F              | 1               | 1        | 4 | Rotate right accumulator.          |

### ROTATE AND SHIFT GROUP (Continued)

| Mnemonic   | Symbolic Operation    | Flags |   | Opcode |     |   |   |    |     | No. of Bytes | No. of M Cycles | No. of T States | Comments |     |   |
|------------|-----------------------|-------|---|--------|-----|---|---|----|-----|--------------|-----------------|-----------------|----------|-----|---|
|            |                       | S     | Z | H      | P/V | N | C | 76 | 543 |              |                 |                 |          | 210 | Hex   |
| RLC r      |                       | ‡     | ‡ | X      | 0   | X | P | 0  | ‡   | 11 001 011   | CB              | 2               | 2        | 8   | Rotate left circular register r.  |
|            |                       |       |   |        |     |   |   |    |     | 00 000 r     |                 |                 |          |     |   |
| RLC (HL)   |                       | ‡     | ‡ | X      | 0   | X | P | 0  | ‡   | 11 001 011   | CB              | 2               | 4        | 15  | r   |
|            |                       |       |   |        |     |   |   |    |     | 00 000 110   |                 |                 |          |     | Reg.  |
| RLC (IX+d) |                       | ‡     | ‡ | X      | 0   | X | P | 0  | ‡   | 11 011 101   | DD              | 4               | 6        | 23  | 000 B   |
|            | r(HL),(IX+d),(IY+d)   |       |   |        |     |   |   |    |     | 11 001 011   | CB              |                 |          |     | 001 C   |
|            |                       |       |   |        |     |   |   |    |     | 00 000 110   |                 |                 |          |     | 010 D   |
|            |                       |       |   |        |     |   |   |    |     | 11 001 011   | CB              |                 |          |     | 011 E   |
|            |                       |       |   |        |     |   |   |    |     | 00 000 110   |                 |                 |          |     | 001 H   |
|            |                       |       |   |        |     |   |   |    |     | 11 111 101   | FD              | 4               | 6        | 23  | 101 L   |
|            |                       |       |   |        |     |   |   |    |     | 11 001 011   | CB              |                 |          |     | 111 A   |
|            |                       |       |   |        |     |   |   |    |     | 00 000 110   |                 |                 |          |     |   |
| RL m       |                       | ‡     | ‡ | X      | 0   | X | P | 0  | ‡   | 00 000 110   |                 |                 |          |     | Instruction format and states are as shown for RLCs. To form new opcode, replace 000 or RLCs with shown code. |
|            | m=r(HL),(IX+d),(IY+d) |       |   |        |     |   |   |    |     | 00 010 110   |                 |                 |          |     |   |
| RRC m      |                       | ‡     | ‡ | X      | 0   | X | P | 0  | ‡   | 00 001       |                 |                 |          |     |   |
|            | m=r(HL),(IX+d),(IY+d) |       |   |        |     |   |   |    |     | 00 001       |                 |                 |          |     |   |
| RR m       |                       | ‡     | ‡ | X      | 0   | X | P | 0  | ‡   | 00 011       |                 |                 |          |     |   |
|            | m=r(HL),(IX+d),(IY+d) |       |   |        |     |   |   |    |     | 00 011       |                 |                 |          |     |   |
| SLA m      |                       | ‡     | ‡ | X      | 0   | X | P | 0  | ‡   | 00 100       |                 |                 |          |     |   |
|            | m=r(HL),(IX+d),(IY+d) |       |   |        |     |   |   |    |     | 00 100       |                 |                 |          |     |   |
| SRA m      |                       | ‡     | ‡ | X      | 0   | X | P | 0  | ‡   | 00 101       |                 |                 |          |     |   |
|            | m=r(HL),(IX+d),(IY+d) |       |   |        |     |   |   |    |     | 00 101       |                 |                 |          |     |   |
| SRL m      |                       | ‡     | ‡ | X      | 0   | X | P | 0  | ‡   | 00 111       |                 |                 |          |     |   |
|            | m=r(HL),(IX+d),(IY+d) |       |   |        |     |   |   |    |     | 00 111       |                 |                 |          |     |   |
| RLD        |                       | ‡     | ‡ | X      | 0   | X | P | 0  | •   | 11 101 101   | ED              | 2               | 5        | 18  | Rotate digit left and right between the accumulator and location (HL).  |
|            |                       |       |   |        |     |   |   |    |     | 01 101 111   | 6F              |                 |          |     |   |
| RRD        |                       | ‡     | ‡ | X      | 0   | X | P | 0  | •   | 11 101 101   | ED              | 2               | 5        | 18  | The content of the upper half of the accumulator is unaffected.   |
|            |                       |       |   |        |     |   |   |    |     | 01 100 111   | 67              |                 |          |     |   |



## JUMP GROUP

| Mnemonic  | Symbolic Operation                                       | Flags |   |   |       |   | Opcode |     |     |     | No. of Bytes | No. of M Cycles | No. of T States | Comments |   |    |  |
|-----------|--|-------|---|---|-------|---|--------|-----|-----|-----|--------------|-----------------|-----------------|----------|---|----|--|
|           |  | S     | Z | H | P/V/N | C | 76     | 543 | 210 | Hex |              |                 |                 |          |   |    |  |
| JP nn     | PC ← nn  | •     | • | X | •     | X | •      | •   | •   | 11  | 000          | 011             | C3              | 3        | 3 | 10 | cc Condition<br>000 NZ (non-zero)<br>001 Z (zero)                                  |
|           |  |       |   |   |       |   |        |     |     |     |              |                 |                 |          |   |    | 010 NC (non-carry)<br>011 C (carry)<br>100 PO (parity odd)<br>101 PE (parity even) |
| JP cc, nn | If condition cc is true PC ← nn, otherwise continue      | •     | • | X | •     | X | •      | •   | •   | 11  | cc           | 010             |                 | 3        | 3 | 10 | 110 P (sign positive)<br>111 M (sign negative)                                     |
| JR e      | PC ← PC + e  | •     | • | X | •     | X | •      | •   | •   | 00  | 011          | 000             | 18              | 2        | 3 | 12 | If condition not met.  |
| JR C, e   | If C = 0, continue<br>If C = 1, PC ← PC + e              | •     | • | X | •     | X | •      | •   | •   | 00  | 111          | 000             | 38              | 2        | 2 | 7  | If condition not met.  |
| JR NC, e  | If C = 1, continue<br>If C = 0, PC ← PC + e              | •     | • | X | •     | X | •      | •   | •   | 00  | 110          | 000             | 30              | 2        | 2 | 7  | If condition not met.  |
| JP Z, e   | If Z = 0, continue<br>If Z = 1, PC ← PC + e              | •     | • | X | •     | X | •      | •   | •   | 00  | 101          | 000             | 28              | 2        | 2 | 7  | If condition not met.  |
| JR NZ, e  | If Z = 1, continue<br>If Z = 0, PC ← PC + e              | •     | • | X | •     | X | •      | •   | •   | 00  | 100          | 000             | 20              | 2        | 2 | 7  | If condition not met.  |
| JP (HL)   | PC ← HL  | •     | • | X | •     | X | •      | •   | •   | 11  | 101          | 001             | E9              | 1        | 1 | 4  |  |
| JP (IX)   | PC ← IX  | •     | • | X | •     | X | •      | •   | •   | 11  | 011          | 101             | DD              | 2        | 2 | 8  |  |
| JP (IY)   | PC ← IY  | •     | • | X | •     | X | •      | •   | •   | 11  | 111          | 101             | FD              | 2        | 2 | 8  |  |
| DJNZ, e   | B ← B - 1<br>If B = 0, continue<br>If B ≠ 0, PC ← PC + e | •     | • | X | •     | X | •      | •   | •   | 00  | 010          | 000             | 10              | 2        | 2 | 8  | If B = 0   |
|           |  |       |   |   |       |   |        |     |     |     |              |                 |                 | 2        | 3 | 13 | If B ≠ 0.  |

NOTES: e represents the extension in the relative addressing mode.  
e is a signed two's complement number in the range < -126, 129 >.  
e - 2 in the opcode provides an effective address of pc + e as PC is incremented by 2 prior to the addition of e.

## CALL AND RETURN GROUP

| Mnemonic   | Symbolic Operation   | Flags |   |   |       |   | Opcode |     |     |     | No. of Bytes | No. of M Cycles | No. of T States | Comments |    |   |    |                       |
|------------|--|-------|---|---|-------|---|--------|-----|-----|-----|--------------|-----------------|-----------------|----------|----|---|----|-----------------------|
|            |  | S     | Z | H | P/V/N | C | 76     | 543 | 210 | Hex |              |                 |                 |          |    |   |    |                       |
| CALL nn    | (SP-1)←PC <sub>H</sub><br>(SP-2)←PC <sub>L</sub><br>PC←nn,                                   | •     | • | X | •     | X | •      | •   | •   | •   | 11           | 001             | 101             | CD       | 3  | 5 | 17 |                       |
| CALL cc,nn | If condition<br>cc is false<br>continue,<br>otherwise<br>same as<br>CALL nn                  | •     | • | X | •     | X | •      | •   | •   | •   | 11           | cc              | 100             |          | 3  | 3 | 10 | If cc is false.       |
|            |  |       |   |   |       |   |        |     |     |     |              |                 |                 |          | 3  | 5 | 17 | If cc is true.        |
| RET        | PC <sub>L</sub> ←(SP)<br>PC <sub>H</sub> ←(SP+1)   | •     | • | X | •     | X | •      | •   | •   | •   | 11           | 001             | 001             | C9       | 1  | 3 | 10 |                       |
| RET cc     | If condition<br>cc is false<br>continue,<br>otherwise<br>same as RET                         | •     | • | X | •     | X | •      | •   | •   | •   | 11           | cc              | 000             |          | 1  | 1 | 5  | If cc is false.       |
|            |  |       |   |   |       |   |        |     |     |     |              |                 |                 |          | 1  | 3 | 11 | If cc is true.        |
|            |  |       |   |   |       |   |        |     |     |     |              |                 |                 |          |    |   |    | cc Condition          |
|            |  |       |   |   |       |   |        |     |     |     |              |                 |                 |          |    |   |    | 000 NZ (non-zero)     |
|            |  |       |   |   |       |   |        |     |     |     |              |                 |                 |          |    |   |    | 001 Z (zero)          |
|            |  |       |   |   |       |   |        |     |     |     |              |                 |                 |          |    |   |    | 010 NC (non-carry)    |
| RETI       | Return from<br>interrupt   | •     | • | X | •     | X | •      | •   | •   | •   | 11           | 101             | 101             | ED       | 2  | 4 | 14 | 011 C (carry)         |
|            |  |       |   |   |       |   |        |     |     |     |              | 01              | 001             | 101      | 4D |   |    | 100 PO (parity odd)   |
| RETN1      | Return from<br>non-maskable<br>interrupt   | •     | • | X | •     | X | •      | •   | •   | •   | 11           | 101             | 101             | ED       | 2  | 4 | 14 | 101 PE (parity even)  |
|            |  |       |   |   |       |   |        |     |     |     |              | 01              | 000             | 101      | 45 |   |    | 110 P (sign positive) |
|            |  |       |   |   |       |   |        |     |     |     |              |                 |                 |          |    |   |    | 111 M (sign negative) |
| RST p      | (SP-1)←PC <sub>H</sub><br>(SP-2)←PC <sub>L</sub><br>PC <sub>H</sub> ←0<br>PC <sub>L</sub> ←p | •     | • | X | •     | X | •      | •   | •   | •   | 11           | t               | 111             |          | 1  | 3 | 11 | t p                   |
|            |  |       |   |   |       |   |        |     |     |     |              |                 |                 |          |    |   |    | 000 00H               |
|            |  |       |   |   |       |   |        |     |     |     |              |                 |                 |          |    |   |    | 001 08H               |
|            |  |       |   |   |       |   |        |     |     |     |              |                 |                 |          |    |   |    | 010 10H               |
|            |  |       |   |   |       |   |        |     |     |     |              |                 |                 |          |    |   |    | 011 18H               |
|            |  |       |   |   |       |   |        |     |     |     |              |                 |                 |          |    |   |    | 100 20H               |
|            |  |       |   |   |       |   |        |     |     |     |              |                 |                 |          |    |   |    | 101 28H               |
|            |  |       |   |   |       |   |        |     |     |     |              |                 |                 |          |    |   |    | 110 30H               |
|            |  |       |   |   |       |   |        |     |     |     |              |                 |                 |          |    |   |    | 111 38H               |

NOTE: 1RETN loads IFF<sub>2</sub> → IFF<sub>1</sub>

## INPUT AND OUTPUT GROUP

| Mnemonic   | Symbolic Operation  | Flags |   |   |       |   | Opcode |     |     | Hex                      | No. of Bytes | No. of M Cycles | No. of T States                    | Comments |  |
|------------|---|-------|---|---|-------|---|--------|-----|-----|--------------------------|--------------|-----------------|------------------------------------|----------|--|
|            |   | S     | Z | H | P/V/N | C | 76     | 543 | 210 |                          |              |                 |                                    |          |  |
| INA, (n)   | A ← (n)   | •     | • | X | •     | X | •      | •   | •   | 11 011 01                | DB           | 2               | 3                                  | 11       | n to A <sub>0</sub> ~ A <sub>7</sub><br>Acc. to A <sub>8</sub> ~ A <sub>15</sub> |
| IN r, (C)  | r ← (C)<br>if r = 110 only<br>the flags will<br>be affected     | ‡     | ‡ | X | ‡     | X | P      | 0   | •   | 11 101 101<br>01 r 000   | ED           | 2               | 3                                  | 12       | C to A <sub>0</sub> ~ A <sub>7</sub><br>B to A <sub>8</sub> ~ A <sub>15</sub>    |
| INI        | (HL) ← (C)<br>B ← B - 1<br>HL ← HL + 1                          | X     | ‡ | X | X     | X | X      | 1   | X   | 11 101 101<br>10 100 010 | ED<br>A2     | 2               | 4                                  | 16       | C to A <sub>0</sub> ~ A <sub>7</sub><br>B to A <sub>8</sub> ~ A <sub>15</sub>    |
| INIR       | (HL) ← (C)<br>B ← B - 1<br>HL ← HL + 1<br>Repeat until<br>B = 0 | X     | 1 | X | X     | X | X      | 1   | X   | 11 101 101<br>10 110 010 | ED<br>B2     | 2               | 5<br>(if B ≠ 0)<br>4<br>(if B = 0) | 21       | C to A <sub>0</sub> ~ A <sub>7</sub><br>B to A <sub>8</sub> ~ A <sub>15</sub>    |
| IND        | (HL) ← (C)<br>B ← B - 1<br>HL ← HL - 1                          | X     | ‡ | X | X     | X | X      | 1   | X   | 11 101 101<br>10 101 010 | ED<br>AA     | 2               | 4                                  | 16       | C to A <sub>0</sub> ~ A <sub>7</sub><br>B to A <sub>8</sub> ~ A <sub>15</sub>    |
| INDR       | (HL) ← (C)<br>B ← B - 1<br>HL ← HL - 1<br>Repeat until<br>B = 0 | X     | 1 | X | X     | X | X      | 1   | X   | 11 101 101<br>10 111 010 | ED<br>BA     | 2               | 5<br>(if B ≠ 0)<br>4<br>(if B = 0) | 21       | C to A <sub>0</sub> ~ A <sub>7</sub><br>B to A <sub>8</sub> ~ A <sub>15</sub>    |
| OUT (n), A | (n) ← A   | •     | • | X | •     | X | •      | •   | •   | 11 010 011               | D3           | 2               | 3                                  | 11       | n to A <sub>0</sub> ~ A <sub>7</sub><br>Acc. to A <sub>8</sub> ~ A <sub>15</sub> |
| OUT (C), r | (C) ← r   | •     | • | X | •     | X | •      | •   | •   | 11 101 101<br>01 r 001   | ED           | 2               | 3                                  | 12       | C to A <sub>0</sub> ~ A <sub>7</sub><br>B to A <sub>8</sub> ~ A <sub>15</sub>    |
| OUTI       | (C) ← (HL)<br>B ← B - 1<br>HL ← HL + 1                          | X     | ‡ | X | X     | X | X      | 1   | X   | 11 101 101<br>10 100 011 | ED<br>A3     | 2               | 4                                  | 16       | C to A <sub>0</sub> ~ A <sub>7</sub><br>B to A <sub>8</sub> ~ A <sub>15</sub>    |
| OTIR       | (C) ← (HL)<br>B ← B - 1<br>HL ← HL + 1<br>Repeat until<br>B = 0 | X     | 1 | X | X     | X | X      | 1   | X   | 11 101 101<br>10 110 011 | ED<br>B3     | 2               | 5<br>(if B ≠ 0)<br>4<br>(if B = 0) | 21       | C to A <sub>0</sub> ~ A <sub>7</sub><br>B to A <sub>8</sub> ~ A <sub>15</sub>    |
| OUTD       | (C) ← (HL)<br>B ← B - 1<br>HL ← HL - 1                          | X     | ‡ | X | X     | X | X      | 1   | X   | 11 101 101<br>10 101 011 | ED<br>AB     | 2               | 4                                  | 16       | C to A <sub>0</sub> ~ A <sub>7</sub><br>B to A <sub>8</sub> ~ A <sub>15</sub>    |
| OTDR       | (C) ← (HL)<br>B ← B - 1<br>HL ← HL - 1<br>Repeat until<br>B = 0 | X     | 1 | X | X     | X | X      | 1   | X   | 11 101 101<br>10 111 011 | ED           | 2               | 5<br>(if B ≠ 0)<br>4<br>(if B = 0) | 21       | C to A <sub>0</sub> ~ A <sub>7</sub><br>B to A <sub>8</sub> ~ A <sub>15</sub>    |

NOTES: ① If the result of B - 1 is zero, the Z flag is set; otherwise it is reset.  
② Z flag is set upon instruction completion only.



## SUMMARY OF FLAG OPERATION

| Instructions  | D <sub>7</sub> |   | Z | H | P/V | N   | D <sub>0</sub> |   | Comments  |
|---|----------------|---|---|---|-----|-----|----------------|---|---|
|   | S              | Z |   |   |     |     | C              | C |   |
| ADD A, s; ADC A, s                                  | ‡              | ‡ | X | ‡ | X   | V   | 0              | ‡ | 8-bit add or add with carry.  |
| SUB s; SBC A, s; CP s; NEG                          | ‡              | ‡ | X | ‡ | X   | V   | 1              | ‡ | 8-bit subtract, subtract with carry, compare and negate accumulator.                                  |
| AND s   | ‡              | ‡ | X | 1 | X   | P   | 0              | 0 | Logical operation.  |
| OR s, XOR s   | ‡              | ‡ | X | 0 | X   | P   | 0              | 0 | Logical operation.  |
| INC s   | ‡              | ‡ | X | ‡ | X   | V   | 0              | • | 8-bit increment.  |
| DEC s   | ‡              | ‡ | X | ‡ | X   | V   | 1              | • | 8-bit decrement.  |
| ADD DD, ss  | •              | • | X | X | X   | •   | 0              | ‡ | 16-bit add.   |
| ADC HL, ss  | ‡              | ‡ | X | X | X   | V   | 0              | ‡ | 16-bit add with carry.  |
| SBC HL, ss  | ‡              | ‡ | X | X | X   | V   | 1              | ‡ | 16-bit subtract with carry.   |
| RLA; RLCA; RRA; RRCA                                | •              | • | X | 0 | X   | •   | 0              | ‡ | Rotate accumulator.   |
| RL m; RLC m; RR m;<br>RRC m; SLA m;<br>SRA m; SRL m | ‡              | ‡ | X | 0 | X   | P   | 0              | ‡ | Rotate and shift locations.   |
| RLD; RRD  | ‡              | ‡ | X | 0 | X   | P   | 0              | • | Rotate digit left and right.  |
| DAA   | ‡              | ‡ | X | ‡ | X   | P   | •              | ‡ | Decimal adjust accumulator.   |
| CPL   | •              | • | X | 1 | X   | •   | 1              | • | Complement accumulator.   |
| SCF   | •              | • | X | 0 | X   | •   | 0              | 1 | Set carry.  |
| CCF   | •              | • | X | X | X   | •   | 0              | ‡ | Complement carry.   |
| IN r (C)  | ‡              | ‡ | X | 0 | X   | P   | 0              | • | Input register indirect.  |
| INI; IND; OUTI; OUTD                                | X              | ‡ | X | X | X   | X   | 1              | • | Block input and output. Z = 1 if B ≠ 0, otherwise Z = 0.  |
| INIR; INDR; OTIR; OTDR                              | X              | 1 | X | X | X   | X   | 1              | • | Block input and output. Z = 1 if B ≠ 0, otherwise Z = 0.  |
| LDI; LDD  | X              | X | X | 0 | X   | ‡   | 0              | • | Block transfer instructions. P/V = 1 if BC ≠ 0, otherwise P/V = 0.                                    |
| LDIR; LDDR  | X              | X | X | 0 | X   | 0   | 0              | • | Block transfer instructions. P/V = 1 if BC ≠ 0, otherwise P/V = 0.                                    |
| CPI; CPIR; CPD; CPDR                                | X              | ‡ | X | X | X   | ‡   | 1              | • | Block search instructions. Z = 1 if A = (HL), otherwise Z = 0. P/V = 1 if BC ≠ 0, otherwise P/V = 0.  |
| LDA; I, LDA, R                                      | ‡              | ‡ | X | 0 | X   | IFF | 0              | • | IFF, the content of the interrupt enable flip-flop, (IFF <sub>2</sub> ), is copied into the P/V flag. |
| BIT b, s  | X              | ‡ | X | 1 | X   | X   | 0              | • | The state of bit b of location s is copied into the Z flag.   |

## SYMBOLIC NOTATION

| Symbol | Operation  | Symbol | Operation   |
|--------|--|--------|---|
| S      | Sign flag. S = 1 if the MSB of the result is 1.  | ‡      | The flag is affected according to the result of the operation.                          |
| Z      | Zero flag. Z = 1 if the result of the operation is 0.  | •      | The flag is unchanged by the operation.   |
| P/V    | Parity or overflow flag. Parity (P) and overflow (V) share the same flag. Logical operations affect this flag with the parity of the result while arithmetic operations affect this flag with the overflow of the result. If P/V holds parity: P/V = 1 if the result of the operation is even; P/V = 0 if result is odd. If P/V holds overflow, P/V = 1 if the result of the operation produced an overflow. If P/V does not hold overflow, P/V = 0. | 0      | The flag is reset by the operation.   |
| H*     | Half-carry flag. H = 1 if the add or subtract operation produced a carry into, or borrow from, bit 4 of the accumulator.   | 1      | The flag is set by the operation.   |
| N*     | Add/Subtract flag. N = 1 if the previous operation was a subtract.   | X      | The flag is indeterminate.  |
| C      | Carry/Link flag. C = 1 if the operation produced a carry from the MSB of the operand or result.  | V      | P/V flag affected according to the overflow result of the operation.                    |
|        |  | P      | P/V flag affected according to the parity result of the operation.                      |
|        |  | r      | Any one of the CPU registers A, B, C, D, E, H, L.                                       |
|        |  | s      | Any 8-bit location for all the addressing modes allowed for the particular instruction. |
|        |  | ss     | Any 16-bit location for all the addressing modes allowed for that instruction.          |
|        |  | ii     | Any one of the two index registers IX or IY.  |
|        |  | R      | Refresh counter.  |
|        |  | n      | 8-bit value in range <0, 255>.  |
|        |  | nn     | 16-bit value in range <0, 65535>.   |

\* H and N flags are used in conjunction with the decimal adjust instruction (DAA) to properly correct the result into packed BCD format following addition or subtraction using operands with packed BCD format.

## CPU REGISTERS

Figure 4 shows three groups of registers within the CPU. The first group consists of duplicate sets of 8-bit registers: a principal set and an alternate set [designated by ' (prime), e.g., A']. Both sets consist of the Accumulator register, the Flag register, and six general-purpose registers. Transfer of data between these duplicate sets of registers is accomplished by use of "Exchange" instructions. The result is faster response to interrupts and easy, efficient implementation of such versatile programming techniques

as background-foreground data processing. The second set of registers consists of six registers with assigned functions. These are the I (Interrupt register), the R (Refresh register), the IX and IY (Index registers), the SP (Stack Pointer), and the PC (Program Counter). The third group consists of two interrupt status flip-flops, plus an additional pair of flip-flops which assists in identifying the interrupt mode at any particular time. Table 1 provides further information on these registers.

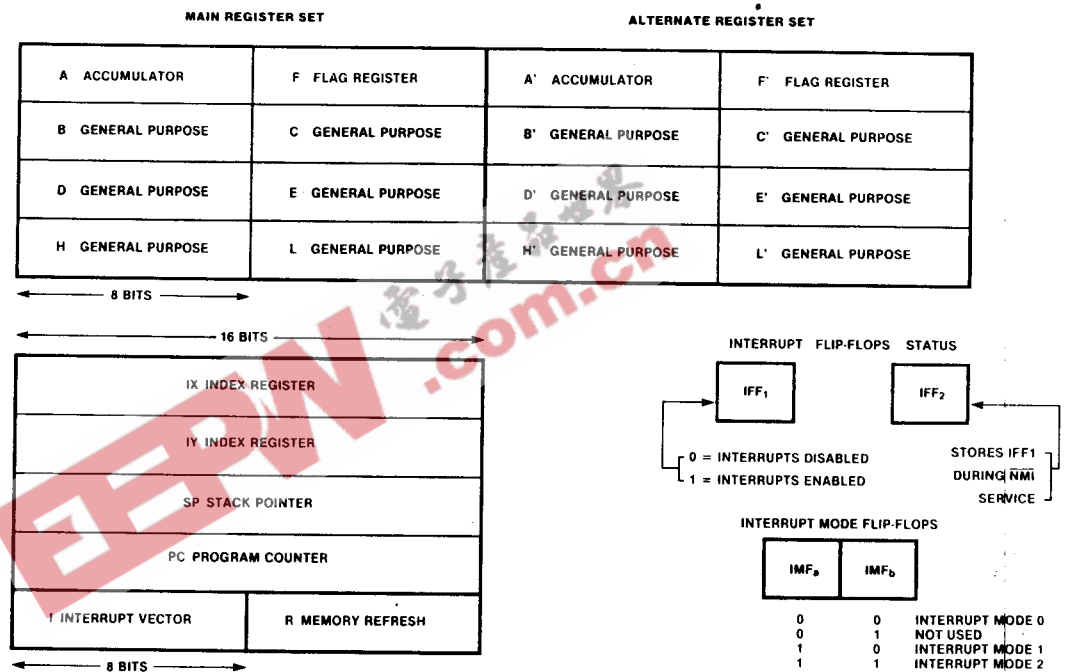

Figure 4. CPU Registers

## INTERRUPTS: GENERAL OPERATION

The CPU accepts two interrupt input signals:  $\overline{\text{NMI}}$  and  $\overline{\text{INT}}$ . The  $\overline{\text{NMI}}$  is a non-maskable interrupt and has the highest priority.  $\overline{\text{INT}}$  is a lower priority interrupt and it requires that interrupts be enabled in software in order to operate.  $\overline{\text{INT}}$  can be connected to multiple peripheral devices in a wired-OR configuration.

The Z80 has a single response mode for interrupt service on the non-maskable interrupt. The maskable interrupt,  $\overline{\text{INT}}$ , has three programmable response modes available. These are:

- Mode 0 — similar to the 8080 microprocessor.
- Mode 1 — Peripheral Interrupt service, for use with non-8080/Z80 systems.

- Mode 2 - a vectored interrupt scheme, usually daisy-chained, for use with the Z80 Family and compatible peripheral devices.

The CPU services interrupts by sampling the  $\overline{\text{NMI}}$  and  $\overline{\text{INT}}$  signals at the rising edge of the last clock of an instruction. Further interrupt service processing depends upon the type of interrupt that was detected. Details on interrupt responses are shown in the CPU Timing Section.

**Non-Maskable Interrupt ( $\overline{\text{NMI}}$ ).** The nonmaskable interrupt cannot be disabled by program control and therefore will be accepted at all times by the CPU.  $\overline{\text{NMI}}$  is usually reserved for servicing only the highest priority type interrupts, such as that for orderly shutdown after power

## PIN DESCRIPTIONS

**A<sub>0</sub>-A<sub>15</sub>.** *Address Bus* (output, active High, 3-state). A<sub>0</sub>-A<sub>15</sub> form a 16-bit address bus. The Address Bus provides the address for memory data bus exchanges (up to 64K bytes) and for I/O device exchanges.

**BUSACK.** *Bus Acknowledge* (output, active Low). Bus Acknowledge indicates to the requesting device that the CPU address bus, data bus, and control signals  $\overline{MREQ}$ ,  $\overline{IORQ}$ ,  $\overline{RD}$ , and  $\overline{WR}$  have entered their high-impedance states. The external circuitry can now control these lines.

**BUSREQ.** *Bus Request* (input, active Low). Bus Request has a higher priority than NMI and is always recognized at the end of the current machine cycle.  $\overline{BUSREQ}$  forces the CPU address bus, data bus, and control signals  $\overline{MREQ}$ ,  $\overline{IORQ}$ ,  $\overline{RD}$ , and  $\overline{WR}$  to go to a high-impedance state so that other devices can control these lines.  $\overline{BUSREQ}$  is normally wired-OR and requires an external pullup for these applications. Extended  $\overline{BUSREQ}$  periods due to extensive DMA operations can prevent the CPU from properly refreshing dynamic RAMs.

**D<sub>0</sub>-D<sub>7</sub>.** *Data Bus* (input/output, active High, 3-state). D<sub>0</sub>-D<sub>7</sub> constitute an 8-bit bidirectional data bus, used for data exchanges with memory and I/O.

**HALT.** *Halt State* (output, active Low).  $\overline{HALT}$  indicates that the CPU has executed a Halt instruction and is awaiting either a nonmaskable or a maskable interrupt (with the mask enabled) before operation can resume. While halted, the CPU executes NOPs to maintain memory refresh.

**INT.** *Interrupt Request* (input, active Low). Interrupt Request is generated by I/O devices. The CPU honors a request at the end of the current instruction if the internal software-controlled interrupt enable flip-flop (IFF) is enabled.  $\overline{INT}$  is normally wired-OR and requires an external pullup for these applications.

**IORQ.** *Input/Output Request* (output, active Low, 3-state).  $\overline{IORQ}$  indicates that the lower half of the address bus holds a valid I/O address for an I/O read or write operation.  $\overline{IORQ}$  is also generated concurrently with  $\overline{M1}$  during an interrupt acknowledge cycle to indicate that an interrupt response vector can be placed on the data bus.

**M1.** *Machine Cycle One* (output, active Low).  $\overline{M1}$ , together with  $\overline{MREQ}$ , indicates that the current machine cycle is the opcode fetch cycle of an instruction execution.  $\overline{M1}$ , together with  $\overline{IORQ}$ , indicates an interrupt acknowledge cycle.

**MREQ.** *Memory Request* (output, active Low, 3-state).  $\overline{MREQ}$  indicates that the address bus holds a valid address for a memory read or memory write operation.

**NMI.** *Non-Maskable Interrupt* (input, negative edge-triggered). NMI has a higher priority than INT. NMI is always recognized at the end of the current instruction, independent of the status of the interrupt enable flip-flop, and automatically forces the CPU to restart at location 0066H.

**RD.** *Read* (output, active Low, 3-state).  $\overline{RD}$  indicates that the CPU wants to read data from memory or an I/O device. The addressed I/O device or memory should use this signal to gate data onto the CPU data bus.

**RESET.** *Reset* (input, active Low).  $\overline{RESET}$  initializes the CPU as follows: it resets the interrupt enable flip-flop, clears the PC and Registers I and R, and sets the interrupt status to Mode 0. During reset time, the address and data bus go to a high-impedance state, and all control output signals go to the inactive state. Note that  $\overline{RESET}$  must be active for a minimum of three full clock cycles before the reset operation is complete.

**RFSH.** *Refresh* (output, active Low).  $\overline{RFSH}$ , together with  $\overline{MREQ}$ , indicates that the lower seven bits of the system's address bus can be used as a refresh address to the system's dynamic memories.

**WAIT.** *Wait* (input, active Low).  $\overline{WAIT}$  indicates to the CPU that the addressed memory or I/O devices are not ready for a data transfer. The CPU continues to enter a Wait state as long as this signal is active. Extended  $\overline{WAIT}$  periods can prevent the CPU from properly refreshing dynamic memory.

**WR.** *Write* (output, active Low, 3-state).  $\overline{WR}$  indicates that the CPU data bus holds valid data to be stored at the addressed memory or I/O location.

## CPU TIMING

The Z80 CPU executes instructions by proceeding through a specific sequence of operations:

- Memory read or write
- I/O device read or write
- Interrupt acknowledge

The basic clock period is referred to as a T time or cycle, and three or more T cycles make up a machine cycle (M1, M2 or M3 for instance). Machine cycles can be extended either by the CPU automatically inserting one or more Wait states or by the insertion of one or more Wait states by the user.

**Instruction Opcode Fetch.** The CPU places the contents of the Program Counter (PC) on the address bus at the start of the cycle (Figure 5). Approximately one-half clock cycle later,  $\overline{MREQ}$  goes active. When active,  $\overline{RD}$  indicates that the memory data can be enabled onto the CPU data bus.

The CPU samples the  $\overline{WAIT}$  input with the falling edge of clock state  $T_2$ . During clock states  $T_3$  and  $T_4$  of an  $\overline{M1}$  cycle, dynamic RAM refresh can occur while the CPU starts decoding and executing the instruction. When the Refresh Control signal becomes active, refreshing of dynamic memory can take place.

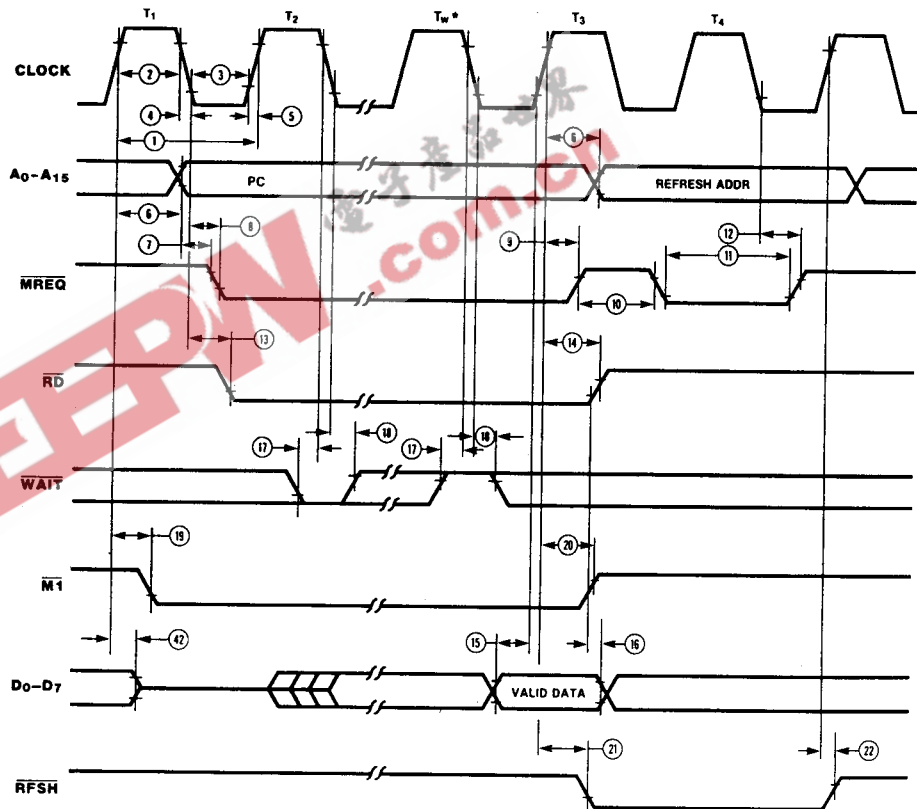

Figure 5. Instruction Opcode Fetch

**Memory Read or Write Cycles.** Figure 6 shows the timing of memory read or write cycles other than an opcode fetch (M1) cycle. The MREQ and  $\overline{RD}$  signals function exactly as in the fetch cycle. In a memory write cycle, MREQ also

becomes active when the address bus is stable. The  $\overline{WR}$  line is active when the data bus is stable, so that it can be used directly as an  $R/\overline{W}$  pulse to most semiconductor memories.

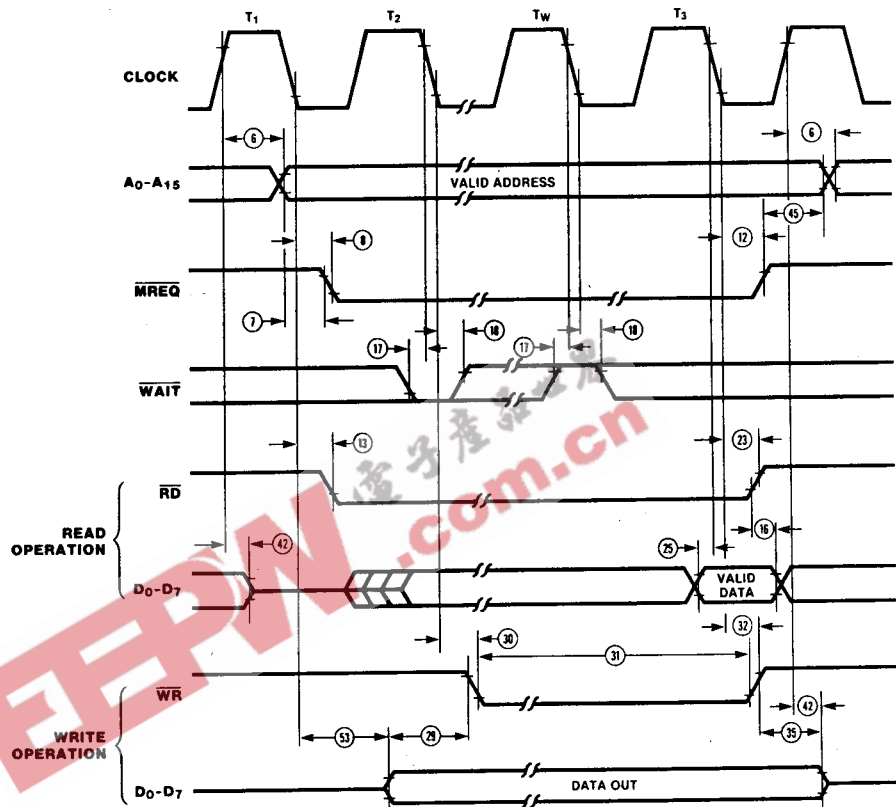
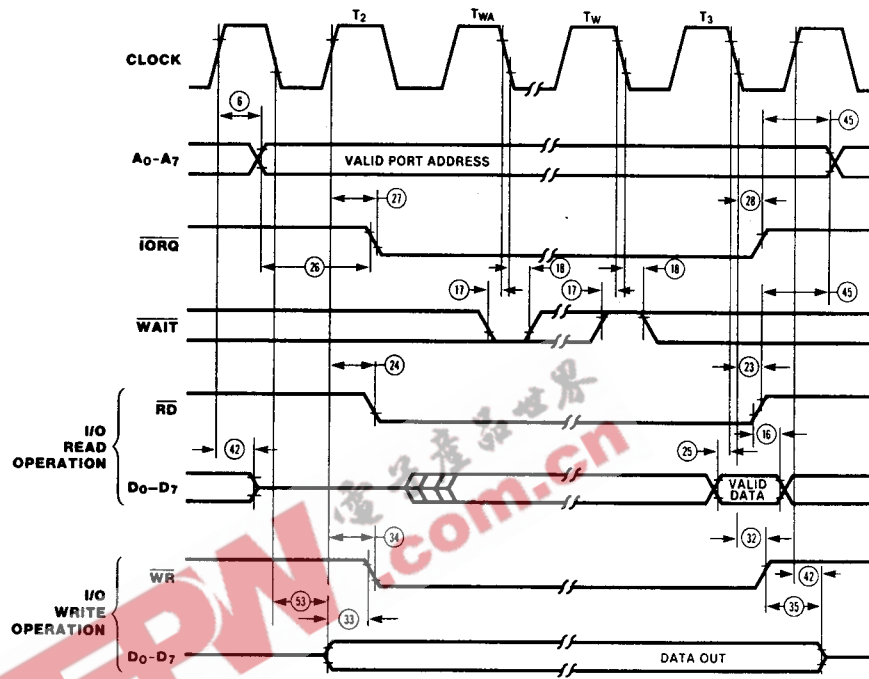

Figure 6. Memory Read or Write Cycles

**Input or Output Cycles.** Figure 7 shows the timing for an I/O read or I/O write operation. During I/O operations, the CPU automatically inserts a single Wait state ( $T_{WA}$ ). This

extra Wait state allows sufficient time for an I/O port to decode the address from the port address lines.



$T_{WA}$  = One wait cycle automatically inserted by CPU.

Figure 7. Input or Output Cycles

**Interrupt Request/Acknowledge Cycle.** The CPU samples the interrupt signal with the rising edge of the last clock cycle at the end of any instruction (Figure 8). When an interrupt is accepted, a special  $\overline{M1}$  cycle is generated.

During this  $\overline{M1}$  cycle,  $\overline{IORQ}$  becomes active (instead of  $\overline{MREQ}$ ) to indicate that the interrupting device can place an 8-bit vector on the data bus. The CPU automatically adds two Wait states to this cycle.

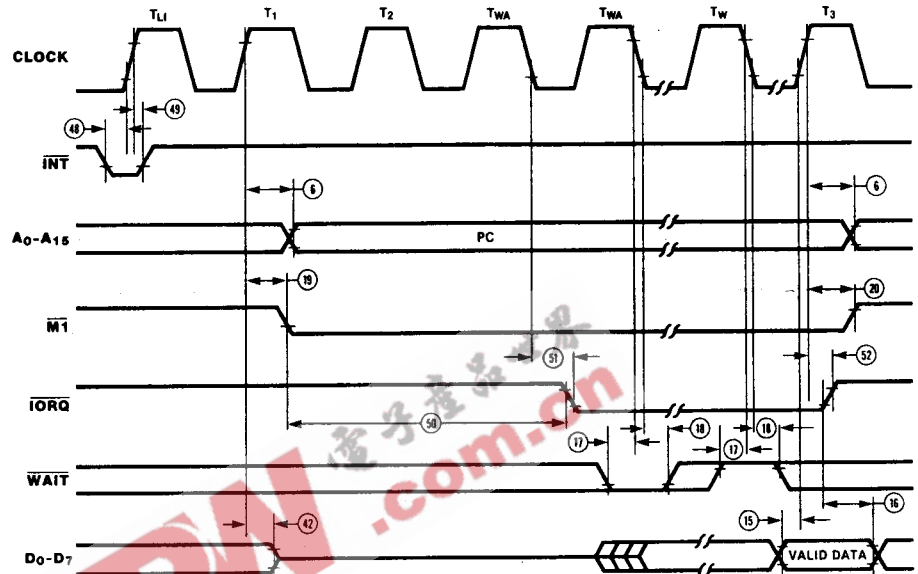

**Non-Maskable Interrupt Request Cycle.**  $\overline{\text{NMI}}$  is sampled at the same time as the maskable interrupt input  $\overline{\text{INT}}$  but has higher priority and cannot be disabled under software control. The subsequent timing is similar to that of a normal

memory read operation except that data put on the bus by the memory is ignored. The CPU instead executes a restart (RST) operation and jumps to the  $\overline{\text{NMI}}$  service routine located at address 0066H (Figure 9).

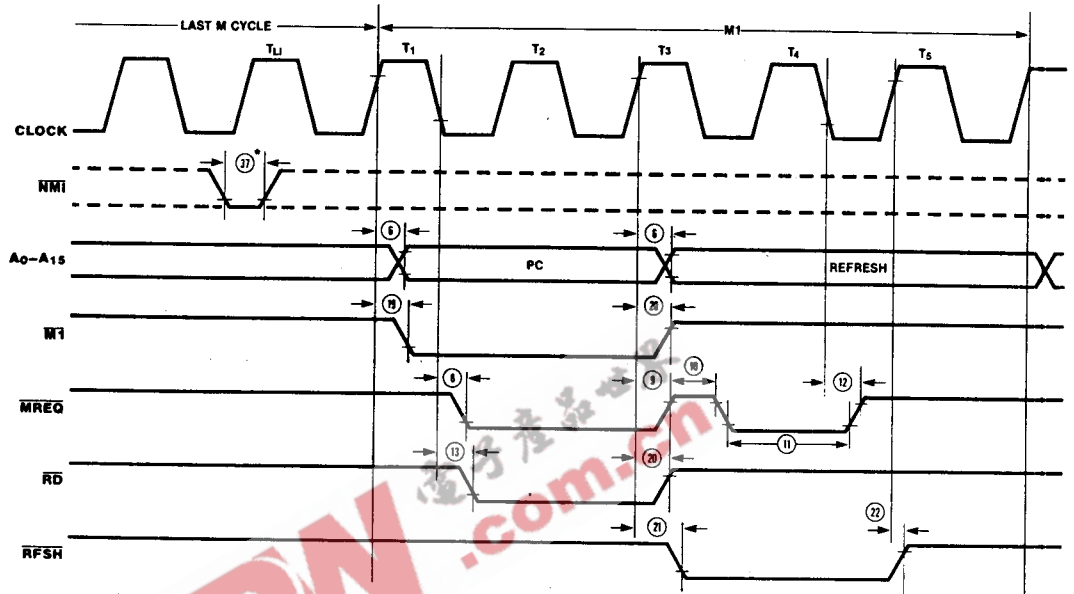

\*Although  $\overline{\text{NMI}}$  is an asynchronous input, to guarantee its being recognized on the following machine cycle,  $\overline{\text{NMI}}$ 's falling edge must occur no later than the rising edge of the clock cycle preceding the last state of any instruction cycle ( $T_U$ ).

Figure 9. Non-Maskable Interrupt Request Operation



**Bus Request/Acknowledge Cycle.** The CPU samples  $\overline{\text{BUSREQ}}$  with the rising edge of the last clock period of any machine cycle (Figure 10). If  $\overline{\text{BUSREQ}}$  is active, the CPU sets its address, data, and  $\overline{\text{MREQ}}$ ,  $\overline{\text{IORQ}}$ ,  $\overline{\text{RD}}$ , and  $\overline{\text{WR}}$  lines

to a high-impedance state with the rising edge of the next clock pulse. At that time, any external device can take control of these lines, usually to transfer data between memory and I/O devices.

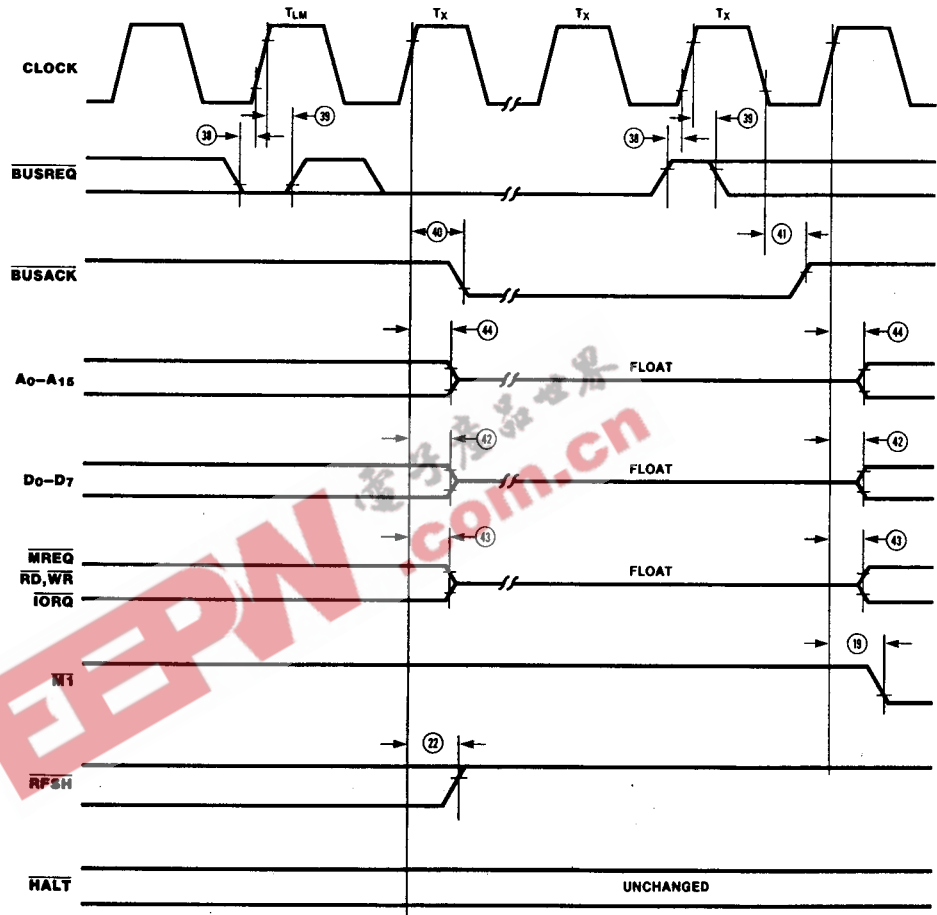

NOTES: 1)  $T_{LM}$  = Last state of any M cycle.  
2)  $T_X$  = An arbitrary clock cycle used by requesting device.

Figure 10. BUS Request/Acknowledge Cycle

**Halt Acknowledge Cycle.** When the CPU receives a HALT instruction, it executes NOP states until either an INT or NMI input is received. When in the Halt state, the HALT output is

active and remains so until an interrupt is received (Figure 11). INT will also force a Halt exit.

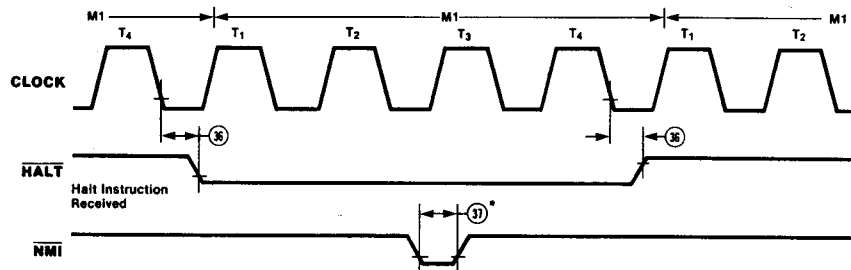

\*Although NMI is an asynchronous input, to guarantee its being recognized on the following machine cycle, NMI's falling edge must occur no later than the rising edge of the clock cycle preceding the last state of any instruction cycle (T<sub>LI</sub>).

Figure 11. Halt Acknowledge

**Reset Cycle.** RESET must be active for at least three clock cycles for the CPU to properly accept it. As long as RESET remains active, the address and data buses float, and the control outputs are inactive. Once RESET goes inactive, two

internal T cycles are consumed before the CPU resumes normal processing operation. RESET clears the PC register, so the first opcode fetch will be to location 0000H (Figure 12).

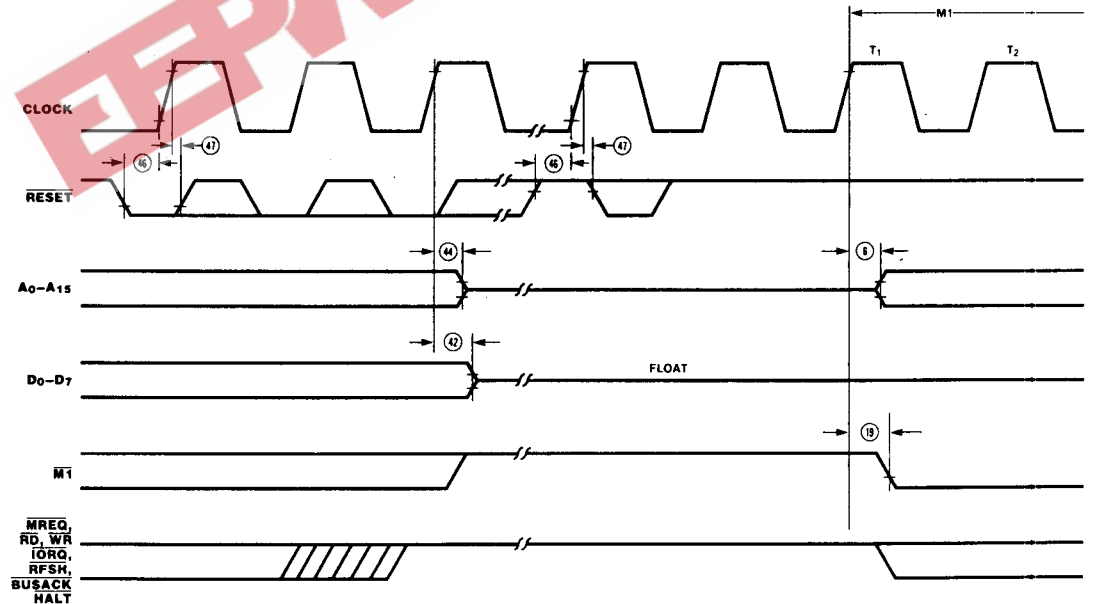

Figure 12. Reset Cycle

**Power-Down mode of operation (Only applies to CMOS Z80 CPU).**  
CMOS Z80 CPU supports Power-Down mode of operation.

This mode is also referred to as the "standby mode", and supply current for the CPU goes down as low as 10  $\mu$ A (Where specified as  $I_{CC2}$ ).

**Power-Down Acknowledge Cycle.** When the clock input to the CPU is stopped at either a High or Low level, the CPU stops its operation and maintains all registers and control signals. However,  $I_{CC2}$  (standby supply current) is guaranteed only when the system clock is stopped at a Low

level during  $T_4$  of the machine cycle following the execution of the HALT instruction. The timing diagram for the power-down function, when implemented with the HALT instruction, is shown in Figure 13.

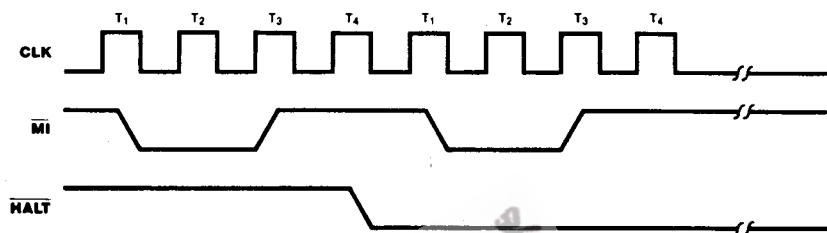

Figure 13. Power-Down Acknowledge

EEPW.com.cn 电子产业世界

**Power-Down Release Cycle.** The system clock must be supplied to the CPU to release the power-down state. When the system clock is supplied to the CLK input, the CPU restarts operations from the point at which the power-down state was implemented. The timing diagrams for the release from power-down mode are shown in Figure 14.

**NOTES:**

- 1) When the external oscillator has been stopped to enter the power-down state, some warm-up time may be required to obtain a stable clock for the release.
- 2) When the HALT instruction is executed to enter the power-down state, the CPU will also enter the Halt state. An interrupt signal (either  $\overline{\text{NMI}}$  or  $\overline{\text{INT}}$ ) or a RESET signal must be applied to the CPU after the system clock is supplied in order to release the power-down state.

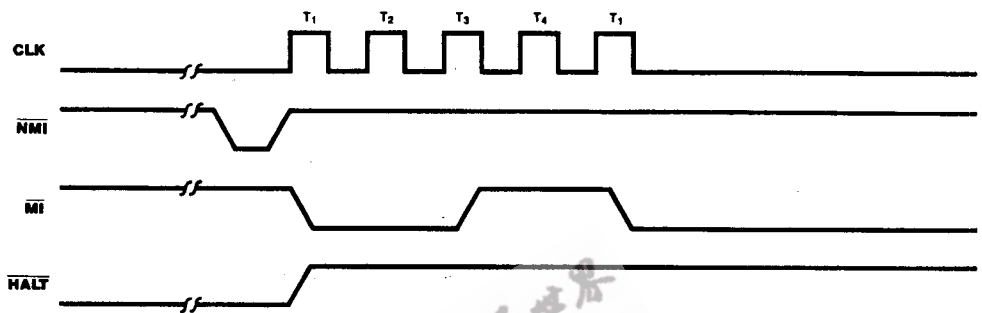

Figure 14a.

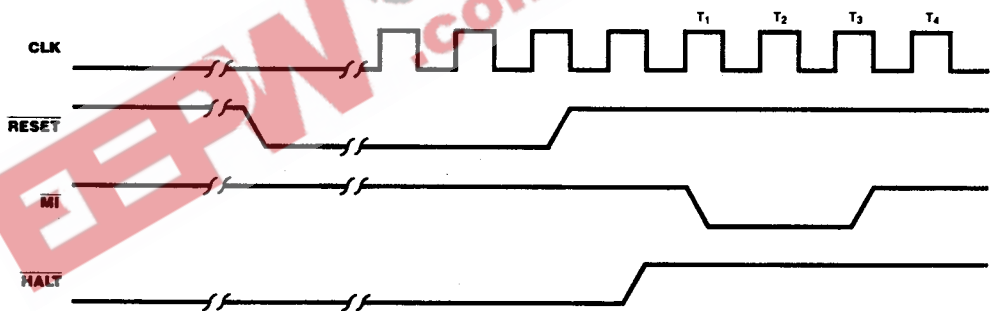

Figure 14b.

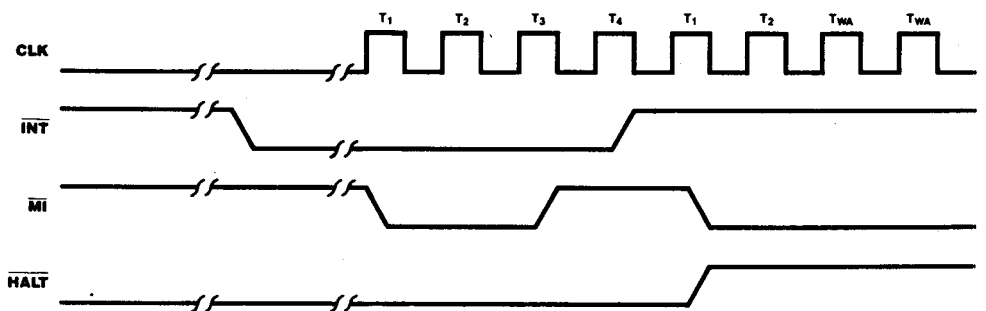

Figure 14c.

Figure 13. Power-Down Release

## ABSOLUTE MAXIMUM RATINGS

|   |                          |
|---|--------------------------|
| Voltage on $V_{CC}$ with respect to $V_{SS}$ . . . . .    | -0.3V to +7V             |
| Voltages on all inputs with respect to $V_{SS}$ . . . . . | -0.3V to $V_{CC} + 0.3V$ |
| Operating Ambient Temperature . . . . .                   | See Ordering Information |
| Storage Temperature . . . . .                             | -65°C to +150°C          |

Stresses greater than those listed under Absolute Maximum Ratings may cause permanent damage to the device. This is a stress rating only; operation of the device at any condition above those indicated in the operational sections of these specifications is not implied. Exposure to absolute maximum rating conditions for extended periods may affect device reliability.

## STANDARD TEST CONDITIONS

The DC Characteristics and capacitance sections below apply for the following standard test conditions, unless otherwise noted. All voltages are referenced to GND (0V). Positive current flows into the referenced pin.

The Ordering Information section lists temperature ranges and product numbers. Package drawings are in the Package Information section. Refer to the Literature List for additional documentation.

Available operating temperature ranges are:

- **S = 0°C to +70°C**  
Voltage Supply Range:  
NMOS:  $+4.75V \leq V_{CC} \leq +5.25V$   
CMOS:  $+4.50V \leq V_{CC} \leq +5.50V$
- **E = -40°C to 100°C,  $+4.50V \leq V_{CC} \leq +5.50V$**

All ac parameters assume a load capacitance of 100 pf. Add 10 ns delay for each 50 pf increase in load up to a maximum of 200 pf for the data bus and 100 pf for address and control lines. AC timing measurements are referenced to 1.5 volts (except for clock, which is referenced to the 10% and 90% points).

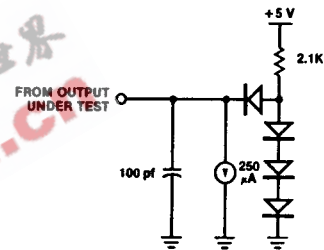

## DC CHARACTERISTICS (Z84C00/CMOS Z80 CPU)

| Symbol           | Parameter                               | Min                  | Max                  | Unit | Condition   |
|------------------|---|----------------------|----------------------|------|---|
| V <sub>ILC</sub> | Clock Input Low Voltage                 | -0.3                 | 0.45                 | V    |   |
| V <sub>IHC</sub> | Clock Input High Voltage                | V <sub>CC</sub> -0.6 | V <sub>CC</sub> +0.3 | V    |   |
| V <sub>IL</sub>  | Input Low Voltage                       | -0.3                 | 0.8                  | V    |   |
| V <sub>IH</sub>  | Input High Voltage                      | 2.2                  | V <sub>CC</sub>      | V    |   |
| V <sub>OL</sub>  | Output Low Voltage                      |                      | 0.4                  | V    | I <sub>OL</sub> = 2.0 mA  |
| V <sub>OH1</sub> | Output High Voltage                     | 2.4                  |                      | V    | I <sub>OH</sub> = -1.6 mA   |
| V <sub>OH2</sub> | Output High Voltage                     | V <sub>CC</sub> -0.8 |                      | V    | I <sub>OH</sub> = -250 μA   |
| I <sub>CC1</sub> | Power Supply Current                    | 4 MHz                | 20                   | mA   | V <sub>CC</sub> = 5V  |
|                  |   | 6 MHz                | 30                   | mA   | V <sub>IH</sub> = V <sub>CC</sub> - 0.2V  |
|                  |   | 8 MHz                | 40                   | mA   | V <sub>IL</sub> = 0.2V  |
|                  |   | 10 MHz               | 50                   | mA   |   |
|                  |   | 20 MHz               | 100                  | mA   | V <sub>CC</sub> = 5V  |
| I <sub>CC2</sub> | Standby Supply Current                  |                      | 10                   | μA   | V <sub>CC</sub> = 5V<br>CLK = (0)<br>V <sub>IH</sub> = V <sub>CC</sub> - 0.2V<br>V <sub>IL</sub> = 0.2V |
| I <sub>LI</sub>  | Input Leakage Current                   | -10                  | 10                   | μA   | V <sub>IN</sub> = 0.4 to V <sub>CC</sub>  |
| I <sub>LO</sub>  | 3-State Output Leakage Current in Float | -10                  | 10 <sup>2</sup>      | μA   | V <sub>OUT</sub> = 0.4 to V <sub>CC</sub>   |

1. Measurements made with outputs floating.
2. A<sub>15</sub>-A<sub>0</sub>, D<sub>7</sub>-D<sub>0</sub>, MREQ, IORQ, RD, and WR.
3. I<sub>CC2</sub> standby supply current is guaranteed only when the supplied clock is stopped at a low level during T<sub>4</sub> of the machine cycle immediately following the execution of a HALT instruction.

## CAPACITANCE

| Symbol             | Parameter          | Min | Max | Unit |
|--------------------|--------------------|-----|-----|------|
| C <sub>CLOCK</sub> | Clock Capacitance  |     | 10  | pf   |
| C <sub>IN</sub>    | Input Capacitance  |     | 5   | pf   |
| C <sub>OUT</sub>   | Output Capacitance |     | 15  | pf   |

T<sub>A</sub> = 25°C, f = 1 MHz.

Unmeasured pins returned to ground.

## AC CHARACTERISTICS† (Z84C00/CMOS Z80 CPU)

V<sub>CC</sub>=5.0V ± 10%, unless otherwise specified

| No | Symbol        | Parameter   | Z84C0004** |     | Z84C0006 |     | Z84C0008 |     | Z84C0010 |     | Z84C0020[1] |     | Unit | Note |
|----|---------------|---|------------|-----|----------|-----|----------|-----|----------|-----|-------------|-----|------|------|
|    |               |   | Min        | Max | Min      | Max | Min      | Max | Min      | Max | Min         | Max |      |      |
| 1  | TcC           | Clock Cycle time  | 250*       | DC  | 162*     | DC  | 125*     | DC  | 100*     | DC  | 50*         | DC  | nS   |      |
| 2  | TwCh          | Clock Pulse width (high)                                | 110        | DC  | 65       | DC  | 55       | DC  | 40       | DC  | 20          | DC  | nS   |      |
| 3  | TwCl          | Clock Pulse width (low)                                 | 110        | DC  | 65       | DC  | 55       | DC  | 40       | DC  | 20          | DC  | nS   |      |
| 4  | TfC           | Clock Fall time   |            | 30  |          | 20  |          | 10  |          | 10  |             | 10  | nS   |      |
| 5  | TrC           | Clock Rise time   |            | 30  |          | 20  |          | 10  |          | 10  |             | 10  | nS   |      |
| 6  | TdCr(A)       | Address valid from Clock Rise                           |            | 110 |          | 90  |          | 80  |          | 65  |             | 57  | nS   | [2]  |
| 7  | TdA(MREQf)    | Address valid to /MREQ Fall                             | 65*        |     | 35*      |     | 20*      |     | 5*       |     | -15*        |     | nS   |      |
| 8  | TdCl(MREQf)   | Clock Fall to /MREQ Fall delay                          |            | 85  |          | 70  |          | 60  |          | 55  |             | 40  | nS   |      |
| 9  | TdCr(MREQr)   | Clock Rise to /MREQ Rise delay                          |            | 85  |          | 70  |          | 60  |          | 55  |             | 40  | nS   |      |
| 10 | TwMREQh       | /MREQ pulse width (High)                                | 110*       |     | 65*      |     | 45**     |     | 30*      |     | 10*         |     | nS   | [3]  |
| 11 | TwMREQl       | /MREQ pulse width (low)                                 | 220*       |     | 132*     |     | 100*     |     | 75*      |     | 25*         |     | nS   | [3]  |
| 12 | TdCl(MERQr)   | Clock Fall to /MREQ Rise delay                          |            | 85  |          | 70  |          | 60  |          | 55  |             | 40  | nS   |      |
| 13 | TdCl(RDf)     | Clock Fall to /RD Fall delay                            |            | 95  |          | 80  |          | 70  |          | 65  |             | 40  | nS   |      |
| 14 | TdCr(RDr)     | Clock Rise to /RD Rise delay                            |            | 85  |          | 70  |          | 60  |          | 55  |             | 40  | nS   |      |
| 15 | TsD(Cr)       | Data setup time to Clock Rise                           | 35         |     | 30       |     | 30       |     | 25       |     | 12          |     | nS   |      |
| 16 | ThD(RDr)      | Data hold time after /RD Rise                           | 0          |     | 0        |     | 0        |     | 0        |     | 0           |     | nS   |      |
| 17 | TsWAIT(Cf)    | /WAIT setup time to Clock Fall                          | 70         |     | 60       |     | 50       |     | 20       |     | 7.5         |     | nS   |      |
| 18 | ThWAIT(Cf)    | /WAIT hold time after Clock Fall                        | 10         |     | 10       |     | 10       |     | 10       |     | 10          |     | nS   |      |
| 19 | TdCr(M1f)     | Clock Rise to /M1 Fall delay                            |            | 100 |          | 80  |          | 70  |          | 65  |             | 45  | nS   |      |
| 20 | TdCr(M1r)     | Clock Rise to /M1 Rise delay                            |            | 100 |          | 80  |          | 70  |          | 65  |             | 45  | nS   |      |
| 21 | TdCr(RFSHf)   | Clock Rise to /RFSH Fall delay                          |            | 130 |          | 110 |          | 95  |          | 80  |             | 60  | nS   |      |
| 22 | TdCr(RFSHr)   | Clock Rise to /RFSH Rise delay                          |            | 120 |          | 100 |          | 85  |          | 80  |             | 60  | nS   |      |
| 23 | TdCl(RDr)     | Clock Fall to /RD Rise delay                            |            | 85  |          | 70  |          | 60  |          | 55  |             | 40  | nS   |      |
| 24 | TdCr(RDf)     | Clock Rise to /RD Fall delay                            |            | 85  |          | 70  |          | 60  |          | 55  |             | 40  | nS   |      |
| 25 | TsD(Cf)       | Data setup to Clock Fall during M2, M3, M4 or M5 cycles | 50         |     | 40       |     | 30       |     | 25       |     | 12          |     | nS   |      |
| 26 | TdA(IORQf)    | Address stable prior to /IORQ Fall                      | 180*       |     | 107*     |     | 75*      |     | 50*      |     | 0*          |     | nS   |      |
| 27 | TdCr(IORQf)   | Clock Rise to /IORQ Fall delay                          |            | 75  |          | 65  |          | 55  |          | 50  |             | 40  | nS   |      |
| 28 | TdCl(IORQr)   | Clock Fall to /IORQ Rise delay                          |            | 85  |          | 70  |          | 60  |          | 55  |             | 40  | nS   |      |
| 29 | TdD(WRf)Mw    | Data stable prior to /WR Fall                           | 80*        |     | 22*      |     | 5*       |     | 40*      |     | -10*        |     | nS   |      |
| 30 | TdCl(WRf)     | Clock Fall to /WR Fall delay                            |            | 80  |          | 70  |          | 60  |          | 55  |             | 40  | nS   |      |
| 31 | TwWR          | /WR pulse width   | 220*       |     | 132*     |     | 100*     |     | 75*      |     | 25*         |     | nS   |      |
| 32 | TdCl(WRr)     | Clock Fall to /WR Rise delay                            |            | 80  |          | 70  |          | 60  |          | 55  |             | 40  | nS   |      |
| 33 | TdD(WRf)IO    | Data stable prior to /WR Fall                           | -10*       |     | -55*     |     | -55*     |     | -10*     |     | -30*        |     | nS   |      |
| 34 | TdCr(WRf)     | Clock Rise to /WR Fall delay                            |            | 65  |          | 60  |          | 60  |          | 50  |             | 40  | nS   |      |
| 35 | TdWRr(D)      | Data stable from /WR Rise                               | 60*        |     | 30*      |     | 15*      |     | 10*      |     | 0*          |     | nS   |      |
| 36 | TdCl(HALT)    | Clock Fall to /HALT 'L' or 'H'                          |            | 300 |          | 260 |          | 225 |          | 90  |             | 70  | nS   |      |
| 37 | TwNMI         | /NMI pulse width  | 80         |     | 60       |     | 60       |     | 60       |     | 60          |     | nS   |      |
| 38 | TsBUSREQ (Cr) | /BUSREQ setup time to Clock Rise                        | 50         |     | 50       |     | 40       |     | 30       |     | 15          |     | nS   |      |

\*For clock periods other than the minimums shown, calculate parameters using the table on the following page.  
Calculated values above assumed TrC = TtC = 20 ns.

†Units in nanoseconds (ns).

†† For loading ≥ 50 pf. Decrease width by 10 ns for each additional 50 pf.

\*\*4 MHz CMOS Z80 is obsolete and replaced by 6 MHz

### AC CHARACTERISTICS† (Z84C00/CMOS Z80 CPU; Continued)

V<sub>CC</sub>=5.0V ± 10%, unless otherwise specified

| No | Symbol         | Parameter   | Z84C0004** |     | Z84C0006 |     | Z84C0008 |     | Z84C0010 |     | Z84C0020[1] |     | Unit | Note |
|----|----------------|---|------------|-----|----------|-----|----------|-----|----------|-----|-------------|-----|------|------|
|    |                |   | Min        | Max | Min      | Max | Min      | Max | Min      | Max | Min         | Max |      |      |
| 39 | ThBUSREQ (Cr)  | /BUSREQ hold time after Clock Rise                                    | 10         |     | 10       |     | 10       |     | 10       |     | 10          |     | nS   |      |
| 40 | TdCr (BUSACKf) | Clock Rise to /BASACK Fall delay                                      |            | 100 |          | 90  |          | 80  |          | 75  |             | 40  | nS   |      |
| 41 | TdCf (BUSACKr) | Clock Fall to /BASACK Rise delay                                      |            | 100 |          | 90  |          | 80  |          | 75  |             | 40  | nS   |      |
| 42 | TdCr(Dz)       | Clock Rise to Data float delay  |            | 90  |          | 80  |          | 70  |          | 65  |             | 40  | nS   |      |
| 43 | TdCr(CTz)      | Clock Rise to Control Outputs Float Delay (/MREQ, /IORQ, /RD and /WR) |            | 80  |          | 70  |          | 60  |          | 65  |             | 40  | nS   |      |
| 44 | TdCr(Az)       | Clock Rise to Address float delay                                     |            | 90  |          | 80  |          | 70  |          | 75  |             | 40  | nS   |      |
| 45 | TdCTr(A)       | Address Hold time from /MREQ, /IORQ, /RD or /WR                       | 80*        |     | 35*      |     | 20*      |     | 20*      |     | 0*          |     | nS   |      |
| 46 | TsRESET(Cr)    | /RESET to Clock Rise setup time                                       | 60         |     | 60       |     | 45       |     | 40       |     | 15          |     | nS   |      |
| 47 | ThRESET(Cr)    | /RESET to Clock Rise Hold time  | 10         |     | 10       |     | 10       |     | 10       |     | 10          |     | nS   |      |
| 48 | TsINTf(Cr)     | /INT Fall to Clock Rise Setup Time                                    | 80         |     | 70       |     | 55       |     | 50       |     | 15          |     | nS   |      |
| 49 | ThINTR(Cr)     | /INT Rise to Clock Rise Hold Time                                     | 10         |     | 10       |     | 10       |     | 10       |     | 10          |     | nS   |      |
| 50 | TdM1f (IORQf)  | /M1 Fall to /IORQ Fall delay  | 565*       |     | 359*     |     | 270*     |     | 220*     |     | 100*        |     | nS   |      |
| 51 | TdCf(IORQf)    | /Clock Fall to /IORQ Fall delay                                       |            | 85  |          | 70  |          | 60  |          | 55  |             | 45  | nS   |      |
| 52 | TdCf(IORQr)    | Clock Rise to /IORQ Rise delay  |            | 85  |          | 70  |          | 60  |          | 55  |             | 45  | nS   |      |
| 53 | TdCf(D)        | Clock Fall to Data Valid delay  |            | 150 |          | 130 |          | 115 |          | 110 |             | 75  | nS   |      |

#### Notes:

\* For Clock periods other than the minimum shown, calculate parameters using the following table.

Calculated values above assumed TrC = TIC = maximum.

\*\* 4 MHz CMOS Z80 is obsoleted and replaced by 6 MHz

[1] Z84C0020 parameters are guaranteed with 50pF load Capacitance.

[2] If Capacitive Load is other than 50pF, please use Figure 1. to calculate the value.

[3] Increasing delay by 10nS for each 50pF increase in loading, 200pF max for data lines, and 100pF for control lines.

### FOOTNOTES TO AC CHARACTERISTICS

| No | Symbol       | Parameter               | Z84C0004** | Z84C0006 | Z84C0008 | Z84C0010 | Z84C0020 |
|----|--------------|-------------------------|------------|----------|----------|----------|----------|
| 1  | TcC          | TwCh + TwCl + TrC + TIC |            |          |          |          |          |
| 7  | TdA(MREQf)   | TwCh + TIC              | -65        | -50      | -45      | -45      | -45      |
| 10 | TwMREQh      | TwCh + TIC              | -20        | -20      | -20      | -20      | -20      |
| 11 | TwMREQf      | TcC                     | -30        | -30      | -25      | -25      | -25      |
| 26 | TdA(IORQf)   | TcC                     | -70        | -55      | -50      | -50      | -50      |
| 29 | TdD(WRf)     | TcC                     | -170       | -140     | -120     | -60      | -60      |
| 31 | TwWR         | TcC                     | -30        | -30      | -25      | -25      | -25      |
| 33 | TdD(WRf)     | TwCl + TrC              | -140       | -140     | -120     | -60      | -60      |
| 35 | TdWRr(D)     | TwCl + TrC              | -70        | -55      | -50      | -40      | -25      |
| 45 | TdCTr(A)     | TwCl + TrC              | -50        | -50      | -45      | -30      | -30      |
| 50 | TdM1f(IORQf) | 2TcC + TwCh + TIC       | -65        | -50      | -45      | -30      | -30      |

AC Test Conditions: V<sub>IH</sub> = 2.0 V  
V<sub>IL</sub> = 0.8 V

V<sub>OH</sub> = 1.5 V  
V<sub>OL</sub> = 1.5 V

V<sub>IHC</sub> = V<sub>CC</sub> - 0.6 V  
V<sub>ILC</sub> = 0.45 V

FLOAT = ±0.5 V



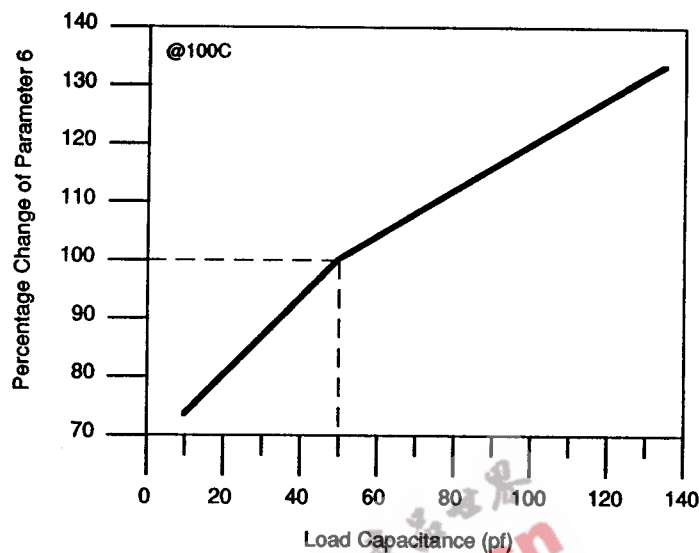

Figure 1. Address Delay Characteristics  
(Parameter 6)

### DC CHARACTERISTICS (Z8400/NMOS Z80 CPU)

All parameters are tested unless otherwise noted.

| Symbol    | Parameter                               | Min              | Max             | Unit          | Test Condition                     |
|-----------|---|------------------|-----------------|---------------|------------------------------------|
| $V_{ILC}$ | Clock Input Low Voltage                 | -0.3             | 0.45            | V             |                                    |
| $V_{IHC}$ | Clock Input High Voltage                | $V_{CC} - .6$    | $V_{CC} + .3$   | V             |                                    |
| $V_{IL}$  | Input Low Voltage                       | -0.3             | 0.8             | V             |                                    |
| $V_{IH}$  | Input High Voltage                      | 2.0 <sup>1</sup> | $V_{CC}$        | V             |                                    |
| $V_{OL}$  | Output Low Voltage                      |                  | 0.4             | V             | $I_{OL} = 2.0 \text{ mA}$          |
| $V_{OH}$  | Output High Voltage                     | 2.4 <sup>1</sup> |                 | V             | $I_{OH} = -250 \mu\text{A}$        |
| $I_{CC}$  | Power Supply Current                    |                  | 200             | mA            | Note 3                             |
| $I_{LI}$  | Input Leakage Current                   |                  | 10              | $\mu\text{A}$ | $V_{IN} = 0 \text{ to } V_{CC}$    |
| $I_{LO}$  | 3-State Output Leakage Current in Float | -10              | 10 <sup>2</sup> | $\mu\text{A}$ | $V_{OUT} = 0.4 \text{ to } V_{CC}$ |

1. For military grade parts, refer to the Z80 Military Electrical Specification.

2.  $A_{15}$ - $A_0$ ,  $D_7$ - $D_0$ ,  $MREQ$ ,  $IORQ$ ,  $RD$ , and  $WR$ .

3. Measurements made with outputs floating.

### CAPACITANCE

Guaranteed by design and characterization.

| Symbol      | Parameter          | Min | Max | Unit |
|-------------|--------------------|-----|-----|------|
| $C_{CLOCK}$ | Clock Capacitance  |     | 35  | pf   |
| $C_{IN}$    | Input Capacitance  |     | 5   | pf   |
| $C_{OUT}$   | Output Capacitance |     | 15  | pf   |

#### NOTES:

$T_A = 25^\circ\text{C}$ ,  $f = 1 \text{ MHz}$ .

Unmeasured pins returned to ground.

## AC CHARACTERISTICS† (Z8400/NMOS Z80 CPU)

| Number | Symbol       | Parameter  | Z0840004 |      | Z0840006 |      | Z0840008 |      |
|--------|--------------|--|----------|------|----------|------|----------|------|
|        |              |  | Min      | Max  | Min      | Max  | Min      | Max  |
| 1      | TcC          | Clock Cycle Time   | 250*     |      | 162*     |      | 125*     |      |
| 2      | TwCh         | Clock Pulse Width (High)   | 110      | 2000 | 65       | 2000 | 55       | 2000 |
| 3      | TwCl         | Clock Pulse Width (Low)  | 110      | 2000 | 65       | 2000 | 55       | 2000 |
| 4      | TfC          | Clock Fall Time  |          | 30   |          | 20   |          | 10   |
| 5      | TrC          | Clock Rise Time  |          | 30   |          | 20   |          | 10   |
| 6      | TdCr(A)      | Clock ↑ to Address Valid Delay   |          | 110  |          | 90   |          | 80   |
| 7      | TdA(MREQf)   | Address Valid to $\overline{\text{MREQ}}$ ↓ Delay  | 65*      |      | 35*      |      | 20*      |      |
| 8      | TdCf(MREQf)  | Clock ↓ to $\overline{\text{MREQ}}$ ↓ Delay  |          | 85   |          | 70   |          | 60   |
| 9      | TdCr(MREQr)  | Clock ↑ to $\overline{\text{MREQ}}$ ↑ Delay  |          | 85   |          | 70   |          | 60   |
| 10     | TwMREQh      | $\overline{\text{MREQ}}$ Pulse Width (High)  | 110*††   |      | 65*††    |      | 45*††    |      |
| 11     | TwMREQl      | $\overline{\text{MREQ}}$ Pulse Width (Low)   | 220*††   |      | 135*††   |      | 100*††   |      |
| 12     | TdCf(MREQr)  | Clock ↓ to $\overline{\text{MREQ}}$ ↑ Delay  |          | 85   |          | 70   |          | 60   |
| 13     | TdCf(RDf)    | Clock ↓ to $\overline{\text{RD}}$ ↓ Delay  |          | 95   |          | 80   |          | 70   |
| 14     | TdCr(RDr)    | Clock ↑ to $\overline{\text{RD}}$ ↑ Delay  |          | 85   |          | 70   |          | 60   |
| 15     | TsD(Cr)      | Data Setup Time to Clock ↑   | 35       |      | 30       |      | 30       |      |
| 16     | ThD(RDr)     | Data Hold Time to $\overline{\text{RD}}$ ↑   |          | 0    |          | 0    |          | 0    |
| 17     | TsWAIT(Cf)   | $\overline{\text{WAIT}}$ Setup Time to Clock ↓   | 70       |      | 60       |      | 50       |      |
| 18     | ThWAIT(Cf)   | $\overline{\text{WAIT}}$ Hold Time after Clock ↓   |          | 0    |          | 0    |          | 0    |
| 19     | TdCr(M1f)    | Clock ↑ to $\overline{\text{M1}}$ ↓ Delay  |          | 100  |          | 80   |          | 70   |
| 20     | TdCr(M1r)    | Clock ↑ to $\overline{\text{M1}}$ ↑ Delay  |          | 100  |          | 80   |          | 70   |
| 21     | TdCr(RFSHf)  | Clock ↑ to $\overline{\text{RFSH}}$ ↓ Delay  |          | 130  |          | 110  |          | 95   |
| 22     | TdCr(RFSHr)  | Clock ↑ to $\overline{\text{RFSH}}$ ↑ Delay  |          | 120  |          | 100  |          | 85   |
| 23     | TdCf(RDr)    | Clock ↓ to $\overline{\text{RD}}$ ↑ Delay  |          | 85   |          | 70   |          | 60   |
| 24     | TdCr(RDf)    | Clock ↑ to $\overline{\text{RD}}$ ↓ Delay  |          | 85   |          | 70   |          | 60   |
| 25     | TsD(Cf)      | Data Setup to Clock ↓ during M <sub>2</sub> , M <sub>3</sub> , M <sub>4</sub> , or M <sub>5</sub> Cycles | 50       |      | 40       |      | 30       |      |
| 26     | TdA(IORQf)   | Address Stable prior to $\overline{\text{IORQ}}$ ↓   | 180*     |      | 110*     |      | 75*      |      |
| 27     | TdCr(IORQf)  | Clock ↑ to $\overline{\text{IORQ}}$ ↓ Delay  |          | 75   |          | 65   |          | 55   |
| 28     | TdCf(IORQr)  | Clock ↓ to $\overline{\text{IORQ}}$ ↑ Delay  |          | 85   |          | 70   |          | 60   |
| 29     | TdD(WRf)     | Data Stable prior to $\overline{\text{WR}}$ ↓  | 80*      |      | 25*      |      | 5*       |      |
| 30     | TdCf(WRf)    | Clock ↓ to $\overline{\text{WR}}$ ↓ Delay  |          | 80   |          | 70   |          | 60   |
| 31     | TwWR         | $\overline{\text{WR}}$ Pulse Width   | 220*     |      | 135*     |      | 100*     |      |
| 32     | TdCf(WRr)    | Clock ↓ to $\overline{\text{WR}}$ ↑ Delay  |          | 80   |          | 70   |          | 60   |
| 33     | TdD(WRf)     | Data Stable prior to $\overline{\text{WR}}$ ↓  | -10*     |      | -55*     |      | 55*      |      |
| 34     | TdCr(WRf)    | Clock ↑ to $\overline{\text{WR}}$ ↓ Delay  |          | 65   |          | 60   |          | 55   |
| 35     | TdWRr(D)     | Data Stable from $\overline{\text{WR}}$ ↑  | 60*      |      | 30*      |      | 15*      |      |
| 36     | TdCf(HALT)   | Clock ↓ to $\overline{\text{HALT}}$ ↑ or ↓   |          | 300  |          | 260  |          | 225  |
| 37     | TwNMI        | NMI Pulse Width  | 80       |      | 70       |      | 60*      |      |
| 38     | TsBUSREQ(Cr) | $\overline{\text{BUSREQ}}$ Setup Time to Clock ↑   | 50       |      | 50       |      | 40       |      |

\* For clock periods other than the minimums shown, calculate parameters using the table on the following page. Calculated values above assumed TrC = TIC = 20 ns.

† Units in nanoseconds (ns).

†† For loading ≥ 50 pf., Decrease width by 10 ns for each additional 50 pf.

### AC CHARACTERISTICS† (Z8400/NMOS Z80 CPU; Continued)

| Number | Symbol        | Parameter  | Z0840004 |     | Z0840006 |     | Z0840008 |     |
|--------|---------------|--|----------|-----|----------|-----|----------|-----|
|        |               |  | Min      | Max | Min      | Max | Min      | Max |
| 39     | ThBUSREQ(Cr)  | BUSREQ Hold Time after Clock ↑                                     | 0        |     | 0        |     | 0        |     |
| 40     | TdCr(BUSACKf) | Clock ↑ to BUSACK ↓ Delay  |          | 100 |          | 90  |          | 80  |
| 41     | TdCf(BUSACKr) | Clock ↓ to BUSACK ↑ Delay  |          | 100 |          | 90  |          | 80  |
| 42     | TdCr(Dz)      | Clock ↑ to Data Float Delay  |          | 90  |          | 80  |          | 70  |
| 43     | TdCr(CTz)     | Clock ↑ to Control Outputs Float Delay<br>(MREQ, IORQ, RD, and WR) |          | 80  |          | 70  |          | 60  |
| 44     | TdCr(Az)      | Clock ↑ to Address Float Delay                                     |          | 90  |          | 80  |          | 70  |
| 45     | TdCr(A)       | MREQ ↑, IORQ ↑, RD ↑, and WR ↑ to<br>Address Hold Time             | 80*      |     | 35*      |     | 20*      |     |
| 46     | TsRESET(Cr)   | RESET to Clock ↑ Setup Time  | 60       |     | 60       |     | 45       |     |
| 47     | ThRESET(Cr)   | RESET to Clock ↑ Hold Time   |          | 0   |          | 0   |          | 0   |
| 48     | TsINTf(Cr)    | INT to Clock ↑ Setup Time  | 80       |     | 70       |     | 55       |     |
| 49     | ThINTR(Cr)    | INT to Clock ↑ Hold Time   |          | 0   |          | 0   |          | 0   |
| 50     | TdM1f(IORQf)  | M1 ↓ to IORQ ↓ Delay   | 565*     |     | 365*     |     | 270*     |     |
| 51     | TdCf(IORQf)   | Clock ↓ to IORQ ↓ Delay  |          | 85  |          | 70  |          | 60  |
| 52     | TdCf(IORQr)   | Clock ↑ to IORQ ↑ Delay  |          | 85  |          | 70  |          | 60  |
| 53     | TdCf(D)       | Clock ↓ to Data Valid Delay  |          | 150 |          | 130 |          | 115 |

\*For clock periods other than the minimums shown, calculate parameters using the following table. Calculated values above assumed TrC = TfC = 20 ns.

†Units in nanoseconds (ns).

### FOOTNOTES TO AC CHARACTERISTICS

| Number | Symbol       | General Parameter       | Z0840004 | Z0840006 | Z0840008 |
|--------|--------------|-------------------------|----------|----------|----------|
| 1      | TcC          | TwCh + TwCl + TrC + TfC |          |          |          |
| 7      | TdA(MREQf)   | TwCh + TfC              | -65      | -50      | -45      |
| 10     | TwMREQh      | TwCh + TfC              | -20      | -20      | -20      |
| 11     | TwMREQl      | TcC                     | -30      | -30      | -25      |
| 26     | TdA(IORQf)   | TcC                     | -70      | -55      | -50      |
| 29     | TdD(WRf)     | TcC                     | -170     | -140     | -120     |
| 31     | TwWR         | TcC                     | -30      | -30      | -25      |
| 33     | TdD(WRf)     | TwCl + TrC              | -140     | -140     | -120     |
| 35     | TdWRr(D)     | TwCl + TrC              | -70      | -55      | -50      |
| 45     | TdCr(A)      | TwCl + TrC              | -50      | -50      | -45      |
| 50     | TdM1f(IORQf) | 2TcC + TwCh + TfC       | -65      | -50      | -45      |

AC Test Conditions:

$V_{IH} = 2.0\text{ V}$        $V_{OH} = 1.5\text{ V}$   
 $V_{IL} = 0.8\text{ V}$        $V_{OL} = 1.5\text{ V}$   
 $V_{IHC} = V_{CC} - 0.6\text{ V}$        $FLOAT = \pm 0.5\text{ V}$   
 $V_{ILC} = 0.45\text{ V}$