



ZY1, ZY3.6 thru ZY200

Vishay Semiconductors
formerly General Semiconductor

Zener Diodes

Vz Range 1.0, 3.6 to 200V
Power Dissipation 2.0W

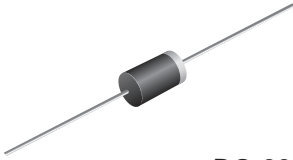

DO-204AM

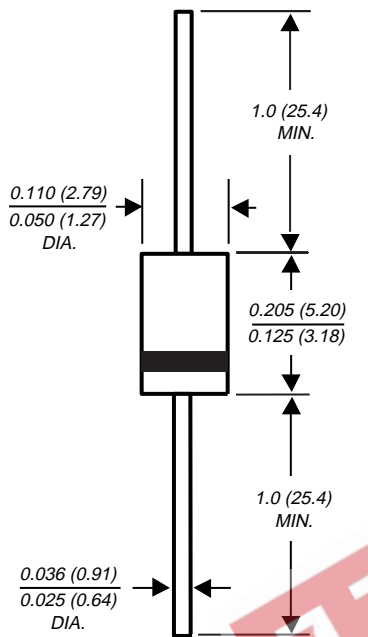

Dimensions in inches and (millimeters)

Extended Voltage Range

Features

- Silicon Power Zener Diodes.
- For use in stabilizing and clipping circuits with high power rating.
- The Zener voltages are graded according to the international E 24 standard. Smaller voltage tolerances are available upon request.

Mechanical Data

Case: JEDEC DO-204AM molded plastic body

Weight: approx. 0.34g

Packaging Codes/Options:

- E2/4K per Ammo mag. (52mm tape), 20K/box
- E3/5K per 13" reel (52mm tape), 10K/box

Maximum Ratings and Thermal Characteristics (T_A = 25°C unless otherwise noted)

Parameter	Symbol	Value	Unit
Zener Current (see Table "Characteristics")			
Power Dissipation at T _{amb} = 25°C	P _{tot}	2.0 ⁽¹⁾	W
Thermal Resistance Junction to Ambient Air	R _{θJA}	60 ⁽¹⁾	°C/W
Junction Temperature	T _j	150	°C
Storage Temperature Range	T _s	-55 to +150	°C

Note:

(1) Valid provided that leads are kept at ambient temperature at a distance of 10mm from case .

ZY1, ZY3.6 thru ZY200

Vishay Semiconductors
formerly General Semiconductor



Electrical Characteristics (T_J = 25°C unless otherwise noted)

Type	Zener voltage ⁽²⁾ at I _{ZT} V _Z (V)	Dynamic resistance at I _{ZT} f = 1 kHz max r _{Zj} (Ω)	Temp. coeff. of Zener volt. at I _{ZT} α _{VZ} (10 ⁻⁴ /K)	Test current I _{ZT} (mA)	Reverse voltage at I _R = 1 μA V _R (V)	Admissible Zener current ⁽¹⁾ at T _{amb} = 25°C I _Z (mA)
ZY1 ⁽³⁾	0.71 ... 0.82	1	-26 ... -16	100	-	1000
ZY3.6	3.4 ... 3.8	7	-7 ... +2	100	-	440
ZY3.9	3.7 ... 4.1	7	-7 ... +2	100	-	410
ZY4.3	4.0 ... 4.6	7	-7 ... +3	100	-	360
ZY4.7	4.4 ... 5.0	7	-7 ... +4	100	-	330
ZY5.1	4.8 ... 5.4	5	-6 ... +5	100	-	300
ZY5.6	5.2 ... 6.0	2	-3 ... +5	100	> 1.5	275
ZY6.2	5.8 ... 6.6	2	-1 ... +6	100	> 1.5	245
ZY6.8	6.4 ... 7.2	2	0 ... +7	100	> 2	220
ZY7.5	7.0 ... 7.9	2	0 ... +7	100	> 2	200
ZY8.2	7.7 ... 8.7	2	+3 ... +8	100	> 3.5	180
ZY9.1	8.5 ... 9.6	4	+3 ... +8	50	> 7.4	165
ZY10	9.4 ... 10.6	4	+5 ... +9	50	> 8.2	145
ZY11	10.4 ... 11.6	7	+5 ... +10	50	> 9.2	135
ZY12	11.4 ... 12.7	7	+5 ... +10	50	> 10	120
ZY13	12.4 ... 14.1	10	+5 ... +10	50	> 10.7	110
ZY15	13.8 ... 15.8	10	+5 ... +10	50	> 12	98
ZY16	15.3 ... 17.1	15	+6 ... +11	25	> 13.3	90
ZY18	16.8 ... 19.1	15	+6 ... +11	25	> 14.7	80
ZY20	18.8 ... 21.2	15	+6 ... +11	25	> 16.5	72
ZY22	20.8 ... 23.3	15	+6 ... +11	25	> 18.3	66
ZY24	22.8 ... 25.6	15	+6 ... +11	25	> 20.1	60
ZY27	25.1 ... 28.9	15	+6 ... +11	25	> 22.5	53
ZY30	28 ... 32	15	+6 ... +11	25	> 25.1	48
ZY33	31 ... 35	15	+6 ... +11	25	> 27.8	44
ZY36	34 ... 38	40	+6 ... +11	10	> 30.2	40
ZY39	37 ... 41	40	+6 ... +11	10	> 32.9	37
ZY43	40 ... 46	45	+7 ... +12	10	> 35.6	33
ZY47	44 ... 50	45	+7 ... +12	10	> 39.2	30
ZY51	48 ... 54	60	+7 ... +12	10	> 42.8	27
ZY56	52 ... 60	60	+7 ... +12	10	> 47.3	25
ZY62	58 ... 66	80	+8 ... +13	10	> 51.7	21
ZY68	64 ... 72	80	+8 ... +13	10	> 57.1	20
ZY75	70 ... 79	100	+8 ... +13	10	> 63.2	18
ZY82	77 ... 88	100	+8 ... +13	10	> 68.6	16
ZY91	85 ... 96	200	+9 ... +13	5	> 75.7	15
ZY100	94 ... 106	200	+9 ... +13	5	> 83.7	13
ZY110	104 ... 116	250	+9 ... +13	5	> 92.6	12
ZY120	114 ... 127	250	+9 ... +13	5	> 101.6	11
ZY130	124 ... 141	300	+9 ... +13	5	> 110.5	10
ZY150	138 ... 156	300	+9 ... +13	5	> 123	9
ZY160	153 ... 171	350	+9 ... +13	5	> 136	8.5
ZY180	168 ... 191	350	+9 ... +13	5	> 149	8
ZY200	188 ... 212	350	+9 ... +13	5	> 167	7.5

Notes: (1) Valid provided that leads are kept at ambient temperature at a distance of 10 mm from case

(2) Tested with pulses t_p = 5 ms

(3) The ZY1 is a silicon diode operated in forward direction. Hence, the index of all parameters ratings should be "F" instead of "Z". Connect the cathode lead to the negative pole



ZY1, ZY3.6 thru ZY200

Vishay Semiconductors
formerly General Semiconductor

Ratings and Characteristic Curves ($T_A = 25^\circ\text{C}$ unless otherwise noted)

Breakdown characteristics

$T_j = \text{constant (pulsed)}$

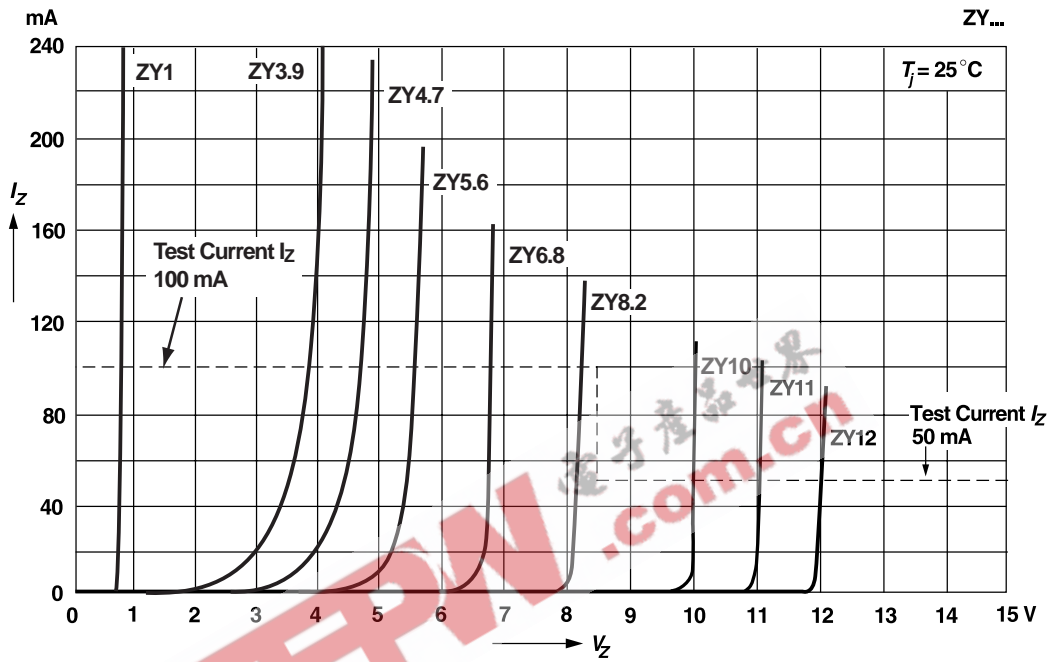

Breakdown characteristics

$T_j = \text{constant (pulsed)}$

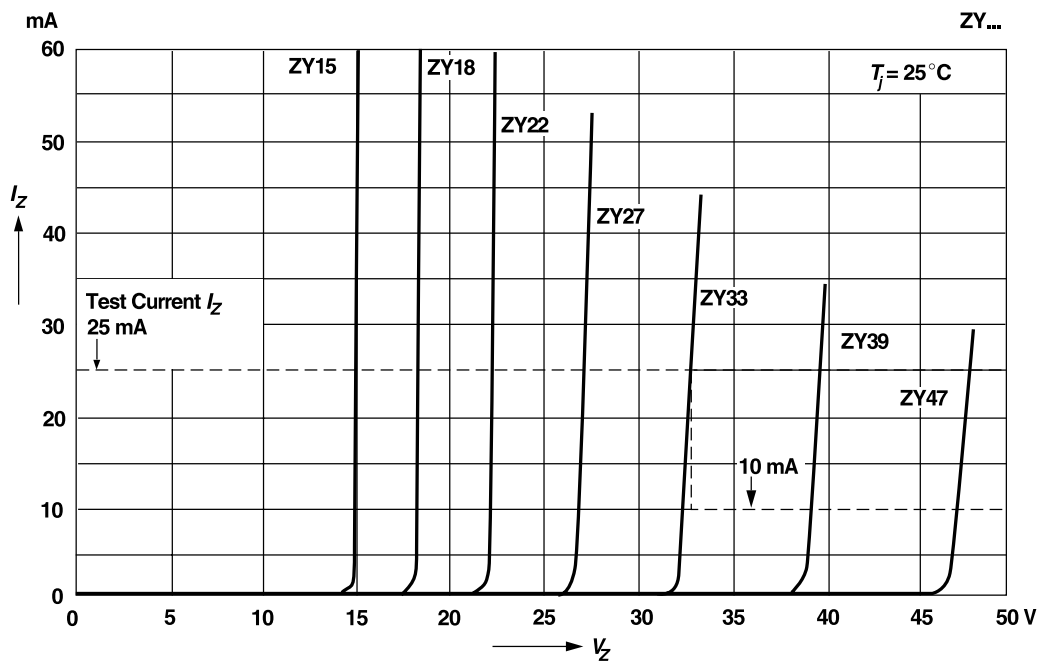

ZY1, ZY3.6 thru ZY200



Vishay Semiconductors
formerly General Semiconductor

Ratings and Characteristic Curves ($T_A = 25^\circ\text{C}$ unless otherwise noted)

Breakdown characteristics

$T_j = \text{constant (pulsed)}$

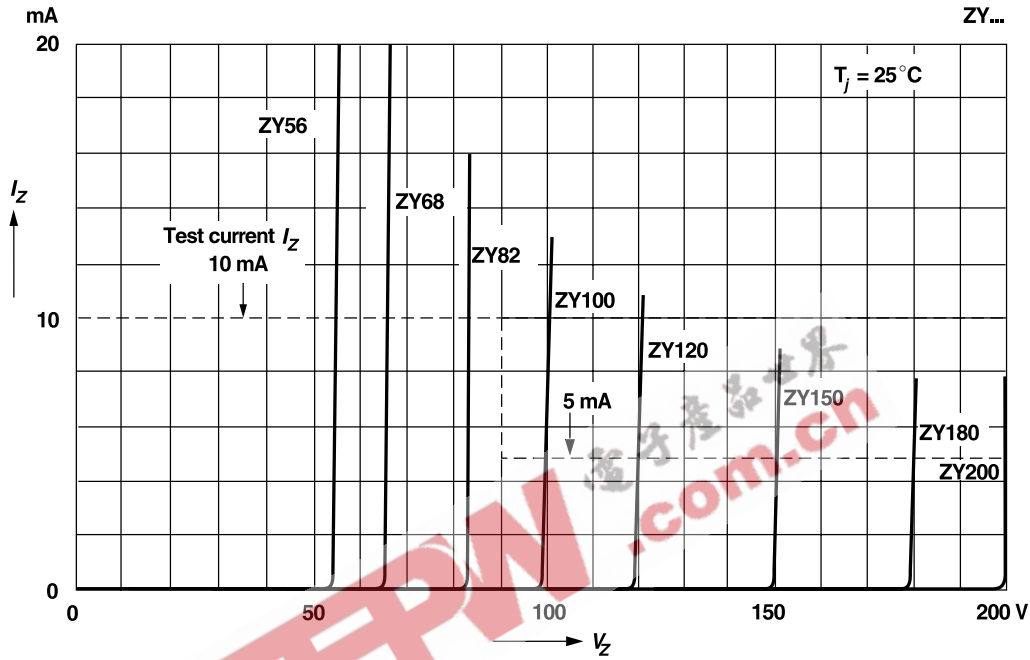

Admissible power dissipation versus ambient temperature

Valid provided that leads are kept at ambient temperature at a distance of 10 mm from case

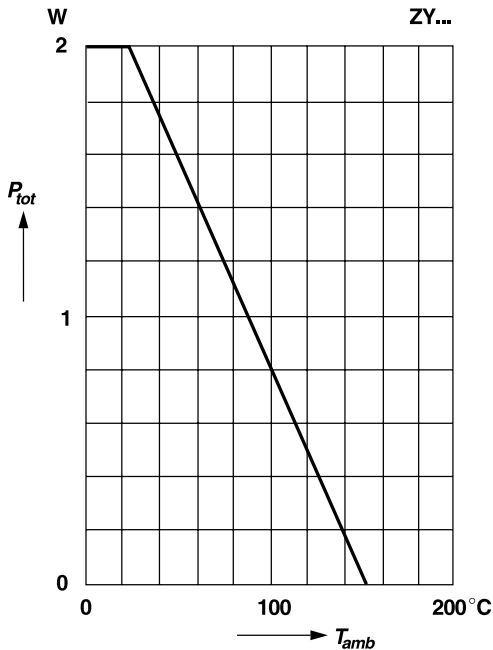

Dynamic resistance versus Zener current

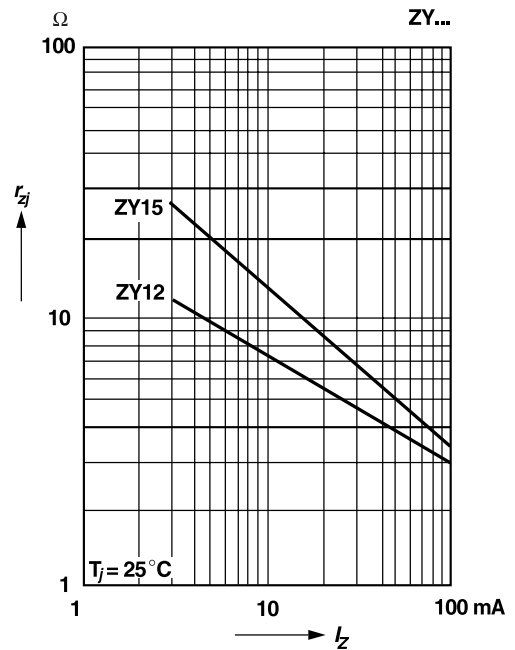



ZY1, ZY3.6 thru ZY200

Vishay Semiconductors
formerly General Semiconductor

Ratings and Characteristic Curves ($T_A = 25^\circ\text{C}$ unless otherwise noted)

Dynamic resistance versus Zener current

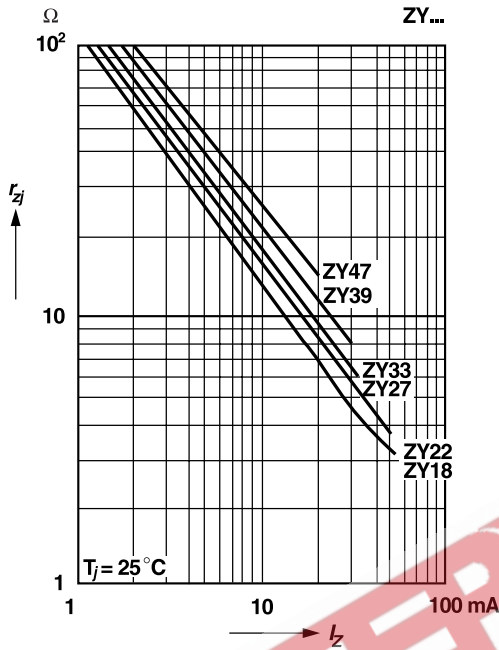

Thermal differential resistance versus Zener voltage

Valid provided that leads are kept at ambient temperature at a distance of 10 mm from case

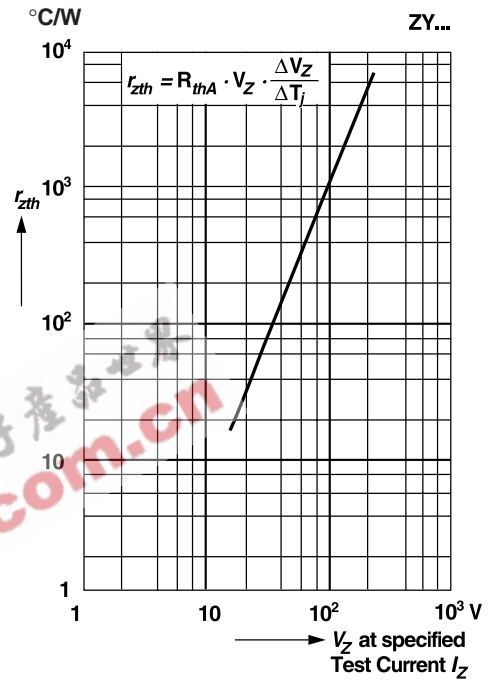

Dynamic resistance versus Zener current

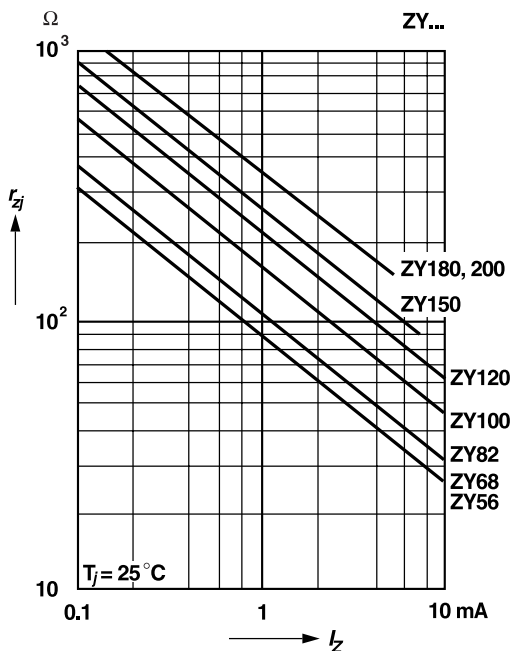

Change of Zener voltage from turn-on up to the point of thermal equilibrium versus Zener Voltage

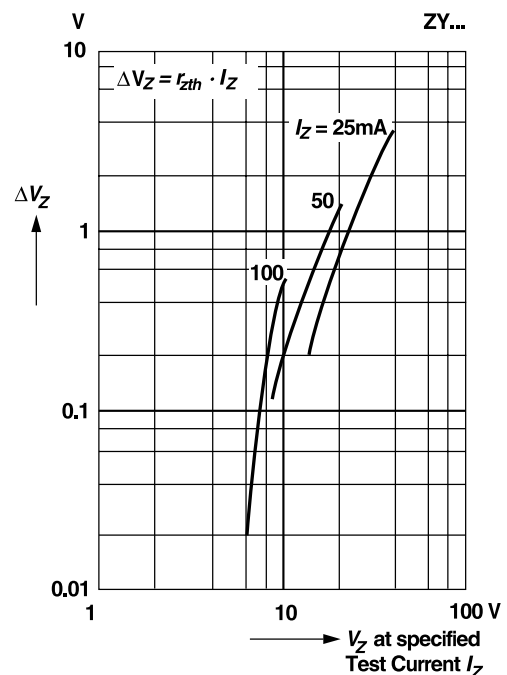

ZY1, ZY3.6 thru ZY200



Vishay Semiconductors
formerly General Semiconductor

Ratings and Characteristic Curves (T_A = 25°C unless otherwise noted)

Relative change of Zener voltage versus turn-on time

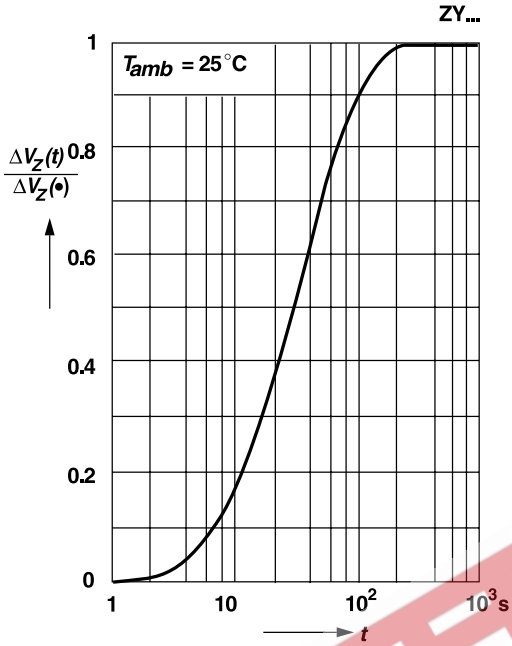

Thermal resistance versus lead length

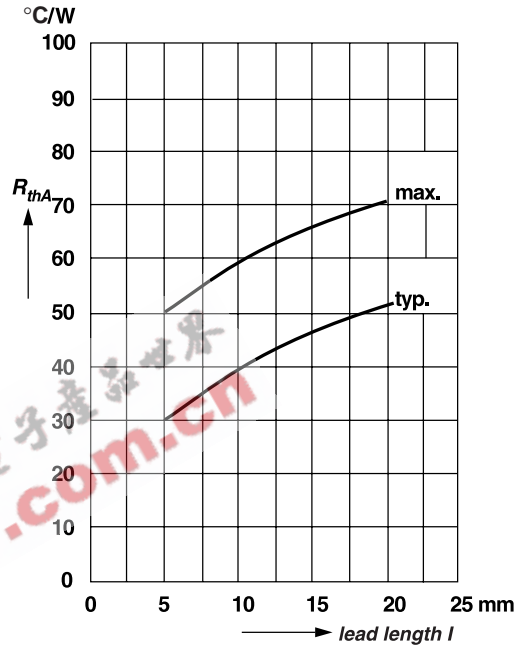

Pulse thermal resistance versus pulse duration

Valid provided that leads are kept at ambient temperature at a distance of 10 mm from case

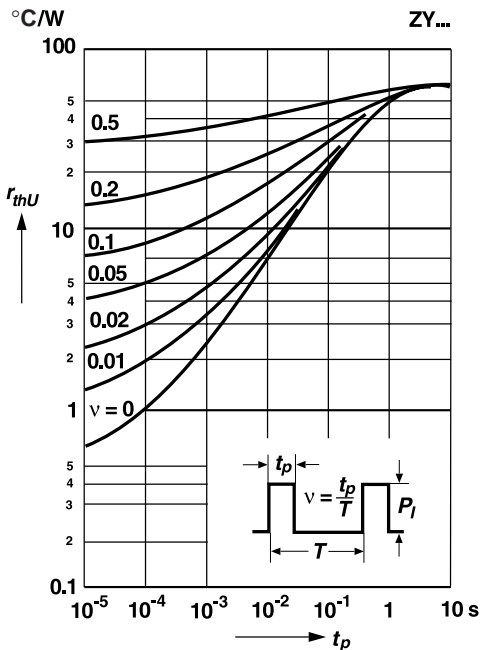



ZY1, ZY3.6 thru ZY200

Vishay Semiconductors
formerly General Semiconductor

Ratings and Characteristic Curves ($T_A = 25^\circ\text{C}$ unless otherwise noted)

Difference between Zener voltage at test current pulses less than 1 s duration and Zener voltage at the point of thermal equilibrium versus Zener current

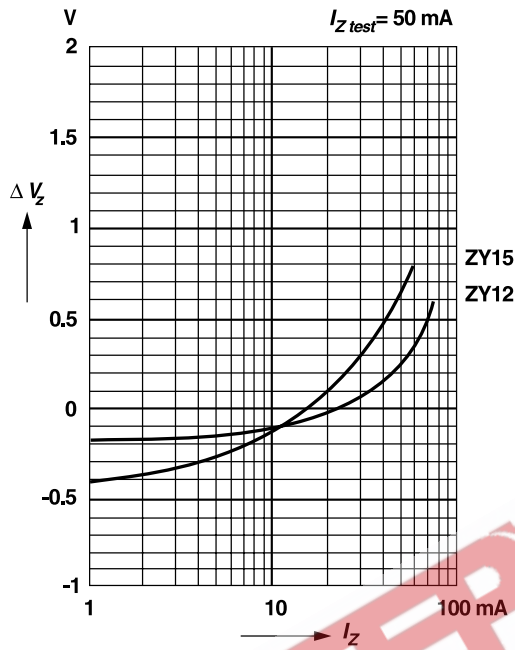

Difference between Zener voltage at test current pulses less than 1 s duration and Zener voltage at the point of thermal equilibrium versus Zener current

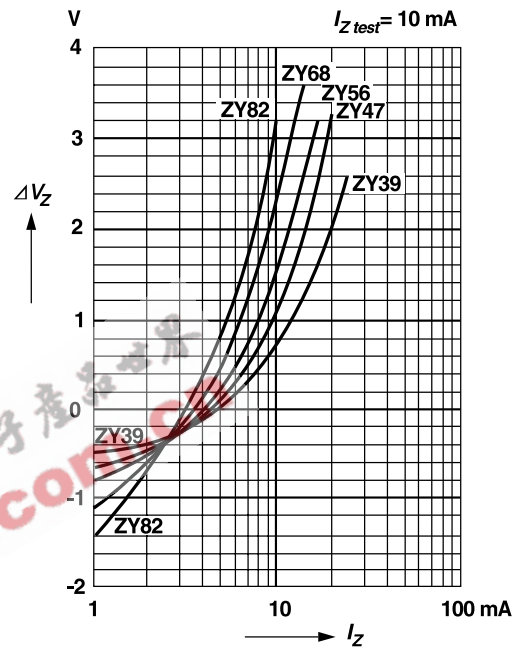

Difference between Zener voltage at test current pulses less than 1 s duration and Zener voltage at the point of thermal equilibrium versus Zener current

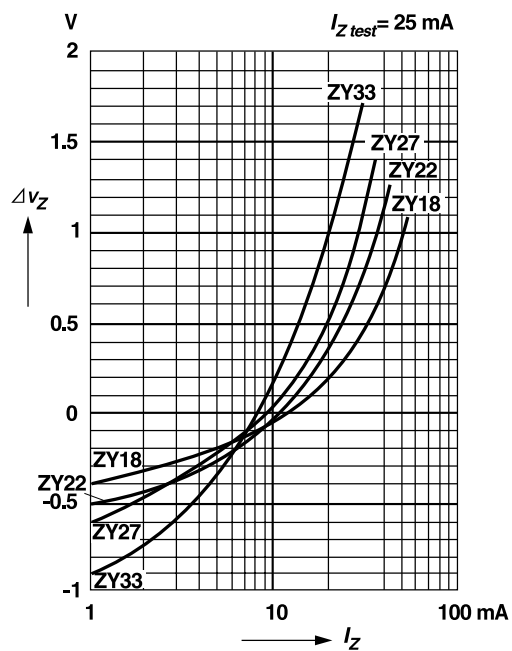

Difference between Zener voltage at test current pulses less than 1 s duration and Zener voltage at the point of thermal equilibrium versus Zener current

